



Tourer Owner's Service & Warranty Handbook

Swift Group, Dunswell Road, Cottingham,
East Yorkshire HU16 4JX.
Tel: 01482 875740 Fax: 01482 840082
email: enquiry@swiftgroup.co.uk
www.swiftgroup.co.uk

1094801
Issued July 2011

Dear owner

Thank you for deciding to buy one of our new caravans.

We are sure you will enjoy many happy hours in it and we hope the information and hints in this handbook will heighten your enjoyment.

The handbook has been designed to give you a general guide to the care, use and maintenance of your caravan. Whether you are a new or an experienced caravanner the hints will help to protect your investment.

The information contained will answer most of your queries, but if there are any aspects which are not covered please consult your appointed dealer. We would suggest you make a note of your dealers name and contact information below.

Dealer Name:

.....

Telephone Number:

.....

E-mail:

.....



Swift Talk

Swift Talk is the new central forum for the Swift community online. A place for all those united in their love of caravanning, motorhomes, holiday homes and touring in general, to share their experiences, meet new friends and find out a world of information on how to enjoy their touring lifestyle.

The site is packed full of features that actively encourage members, not only to liaise with the Swift Group via the forums, but also interact with each other through publishing their own content, uploading and sharing photos and video, and even posting their own blogs for the community to follow.

Swift Talk is the first place to learn about new product launches, events and Swift Group news, it's also the first place customers can go to as a quick reference to frequently asked questions or to actively take part in the forums; providing valuable feedback on Swift Group products and customer service.

The new online community can even be used to create your own groups, perfect for Owners' Clubs, dealers and exhibitors to

attract new members, publicise and build awareness for upcoming events, rallies and shows.

Anyone who owns, uses, or is thinking of buying a Swift Group caravan, motorhome or holiday home, or would just like to be part of the growing Swift community is actively encouraged to sign up, create their own content, and start talking!

Just visit www.swift-talk.co.uk and become part of a unique online experience.

Warranty	5
Towing code	13
Safety & security	33
Services	43
Electrics	65
Fitted equipment	87
Maintenance	159
Useful information	191

WARRANTY INFORMATION

Warranty and guarantee cover	6
3 year manufacturer's warranty ('Warranty')	6
6 year body shell guarantee ('Guarantee')	6
General terms and conditions	6
What to do if you require assistance	8
Supplier contacts	9
Touring caravans - annual service/inspection record	10
Annual service / inspection record stamps	11

All the illustrations and descriptive matter in this handbook are intended to give a general idea of the caravan. Changing market and supply situations and our policy of continuous product development may prevent us from maintaining the exact specifications detailed in this handbook. We therefore reserve the right to alter specifications as materials and conditions demand.

Dealers are not agents of Swift Group Limited ("Swift") and have absolutely no authority to bind the manufacturer by any express or implied undertaking or representation.

YOUR CARAVAN HAS TWO WARRANTIES:

Body Shell Warranty

For the body shell, Swift will repair (or at its option, replace) any defects with the body shell for 6 years from the date of purchase (or hire purchase), subject to the conditions, terms and exclusions below.

SuperSure Warranty

For all parts or fittings of your caravan other than the body shell, Swift will repair (or at its option, replace) any defective parts or fittings for 3 years from the date of purchase (or hire purchase) subject to conditions, terms and exclusions below.

Conditions

1. You must ensure that your caravan has had an Annual Service (see clause 2 below) within 90 days before or 60 days after each anniversary of the original date of purchase. In order to preserve your SuperSure Warranty, the third Annual Service must be carried out before the expiry of the 36 month period from the original date of purchase. In order to preserve your Body Shell Warranty, the sixth Annual Service must be carried out before the expiry of the 72 month period from the original date of purchase. If you have not performed an Annual Service then Swift will not be obliged to perform any work under this Warranty. Original VAT invoices must be retained as proof that Annual Service have been carried out.

2. The Annual Service must be carried out in

accordance with the requirements in this handbook. You will be responsible for any charges made for an Annual Service. If the Annual Service is performed by an authorised Swift Group Service Centre then Swift warrants that the Annual Service has been performed correctly. If the Annual Service is performed by an unauthorised repairer or service centre then if the Annual Service has not been performed in accordance with the requirements in this handbook and/or work has been performed on your caravan that is defective or faulty, then Swift will not be obliged to perform any work under this Warranty (insofar as it relates to defective or faulty work or defective Annual Service).

3. All new caravans must be registered with Swift within 6 weeks of purchase as new.

4. The benefit of this Warranty may be transferred to a new owner if the caravan is re-sold, provided that the caravan has been serviced in accordance with the requirements of this handbook, and details of the change of ownership have been supplied to Swift using the change of ownership form set out in this handbook as soon as reasonably practicable after the change.

5. If any repairs are identified as being necessary during an Annual Service or otherwise, Swift will only pay for Warranty work performed by an authorised Swift Group Service Centre. The caravan must be made available to an authorised Swift Group Service Centre within 6 weeks of the date the repair need was identified for the work to be carried out. The cost of transporting, towing or moving the caravan by any means to or from the place of repair is the responsibility of the owner.

6. The Body Shell Warranty and/or the SuperSure Warranty only apply to caravans purchased and used primarily within the UK, which means that the caravan is not used for continuous journeys outside of the UK of longer than 90 days per journey.

Terms

7. The Body Shell Warranty covers any defect with the panels and seams of the caravan. This includes body leaks, delamination of panels or floor, water ingress through any permanently sealed seam joints.

8. The SuperSure Warranty will cover in the first 12 months any defect other than those specified in the Exclusions below.

9. In years 2 and 3 of the SuperSure Warranty, the Warranty will only cover any defect with the following components:

- Water system, heater, fresh water tank, water pump, water gauges, taps and shower heads;
- Heating system and components;
- Main proprietary items (for example fridge, toilet, cooker);
- Chassis and associated parts;
- Auxiliary electrics ; and
- Windows (excluding window furniture and blinds).

In years 2 and 3 of the SuperSure Warranty, any defect specified in the Exclusions will not be covered.

Exclusions

10. Swift shall not be liable under this Warranty for any defect related to or arising from the following:

- The failure of a component for reasons of fair wear and tear;
- Damage resulting from freezing, fire, overheating or accidents (whether caused by the user or a third party);
- Misuse of any component;
- Normal deterioration, corrosion, intrusion of foreign or harmful bodies, lack of servicing or negligence of any person other than Swift which causes stoppage of or impairment to the function of any component of the caravan;
- Replacement of parts which have reached the end of their effective working life because of age and/or usage;
- Cleaning or adjustment of any assemblies;

- Cosmetic finishes to kitchen sinks, cooker tops, vanity units, shower trays; and/or
 - Routine maintenance items which are part of the annual service including brake shoes, one shot nuts, lubricants, AKS pads, rubber gas hose, the cleaning of the heater and fridge flues, the replacement of gas jets, the resealing and/or replacement of shower room sealant, and the adjustment and lubrication of locks.
11. In addition to the exclusions above, in years 2 and 3 of the Warranty Period, Swift shall not be liable under this Warranty for any defects related to:
- Any audio equipment;
 - Any microwave; and/or
 - Any TV.

12. Swift shall not be liable under this Warranty if the caravan has been neglected, misused, modified or used for hire or reward or if the identification marks (chassis/VIN numbers) have been removed or defaced. The caravan will be deemed to have been neglected if it has not been serviced and maintained as stated in this handbook or any repairs being identified as necessary at an Annual Service or by a Swift Group Service Centre have not been carried out in a reasonable time.

You have legal rights under UK law governing the sale of consumer goods. These warranties do not affect your legal rights.

The name and address of the warranty and Guarantee provider is:

Swift Group Limited, Dunswell Road, Cottingham, East Yorkshire, HU16 4JX.

In the unusual event that a fault develops and you need to claim under Body Shell Warranty or the SuperSure Warranty, your first contact should normally be made through the dealer from whom the caravan was purchased. If this is not feasible then a claim may be dealt with by a different authorised Swift Group Service Centre, please contact the Swift Group Customer Care Department on 01482 875740 or enquiring on our website: www.swiftleisure.co.uk directly for details.:

WHAT TO DO IF YOU REQUIRE ASSISTANCE

Congratulations on purchasing your new caravan. We are confident that you will enjoy many happy holidays. However, should you have an enquiry or require assistance with a problem, we hope that this guide will be of assistance to you.

If you have a problem, or enquiry with regards to your new caravan, please follow these steps:

1. Check the Owners Handbook, paying particular attention to the fault finding advice at the back of the book.
2. Contact your supplying dealer for assistance.

If you need to contact the Swift Group, please be aware of the following:

1. When contacting Swift Customer Care, please quote your name, postcode and serial number of your caravan.
2. In most instances, the Customer Care Team will involve your dealer in resolving the issue you are experiencing.
3. If you are contacting the company by email, letter or fax, the Customer Care Team will respond to you within five working days from the date of receiving the correspondence.
4. If you are calling the Customer Care Team, please avoid where possible, Mondays and lunch times.
5. Please be aware that the Swift Group cannot send parts direct from the factory. In all cases, without exception, your dealer must place the order for you.

SUPPLIER CONTACTS

A number of Swift Group suppliers manage their own Technical and Warranty related queries. Where a customer has a question relating to a product manufactured by a company listed below, we would advise that the first contact should be directly with them.

SARGENT

Sargent Electrical Services

Unit 39, Tokenspire Business Park, Beverley, East Yorkshire, HU17 0TB

Phone: 01482 678981

Fax: 01482 678987

E-mail: support@sargentltd.co.uk

AL-KO

AL-KO Kober Limited

South Warwickshire Business Park
Kineton Road, Southam,
Warwickshire, CV47 0AL

Fax: 01926 818562

Email: mail@al-ko.co.uk

truma

Truma UK Ltd.

Park lane, Dove Valley Park,
South Derbyshire, DE65 5BG

Phone: 01283 586020

Fax: 01283 586029

technical@truma.com

THETFORD Corporation

Thetford Ltd.

Unit 19, Oakham Drive,
Parkwood Industrial Estate,
Rutland Road, Sheffield, S3 9QX

Phone: 0114 273 8157

Fax: 0114 275 3094

Email: infogb@thetford.eu

Alde

Alde International (UK) Ltd

Regent Park, Park Farm South,
Wellingborough, Northants, NN8 6GR

Phone: 01933 677765

Fax: 01933 674975

Email: info@alde.co.uk

SERVICE INSPECTION

TOURING CARAVANS - ANNUAL SERVICE/INSPECTION RECORD

In order to comply with the warranty, you must have your caravan inspected and serviced by an authorised Swift Group Service Centre at least once per year.

It is important that the Owner's Handbook is stamped on the appropriate page by the authorised Swift Group Service Centre. Failure to do this will invalidate the warranty and the transfer of the warranty on the change of ownership.

The inspection should take approximately two to four hours and will cover the areas dealt with in the annual service check list. Any areas requiring service and/or maintenance will be highlighted by your dealer and we recommend that you authorise any necessary work to be carried out.

NB. It is essential, to validate the warranty, that an annual inspection be carried out by an authorised Swift Group Service Centre covering the items listed.

1. Damp and lamination test.
2. Coupling head and breakaway cable.
3. Jockey wheel.
4. Chassis and chassis to body security.
5. Corner steadies.
6. Tyres and tyre pressures.
7. Torque wheel nuts.
8. Brake rods and linkages.
9. Hub bearings, brakes and brake shoes.
10. Handbrake operation and performance.
11. Suspension and shock absorbers (if fitted).
12. 13 pin plug and cables.
13. Road lights, wiring and reflectors.

14. Internal lights and 12V DC system.
15. Water heater - gas and 230V AC (if fitted).
16. Hob, grill and oven (if fitted).
17. Refrigerator 230V AC, 12V DC and gas.
18. Gas system.
19. Water pump, taps and water system.
20. Mains 230V AC system.
21. Windows and fittings.
22. Smoke alarm and battery.
23. Roof lights.
24. Furniture hinges/stays etc.
25. Exterior locks and hinges.
26. Grab handle security.
27. All internal vents.
28. Oil seals.
29. Blinds and fly screens (if fitted).

Annual service / inspection record stamps Caravan model: Year: Chassis number:	1st SERVICE DATE: DEALER'S STAMP We certify that an annual service has been carried out in accordance with the handbook.
2nd SERVICE DATE: DEALER'S STAMP We certify that an annual service has been carried out in accordance with the handbook.	3rd SERVICE DATE: DEALER'S STAMP We certify that an annual service has been carried out in accordance with the handbook.
4th SERVICE DATE: DEALER'S STAMP We certify that an annual service has been carried out in accordance with the handbook.	5th SERVICE DATE: DEALER'S STAMP We certify that an annual service has been carried out in accordance with the handbook.
6th SERVICE DATE: DEALER'S STAMP We certify that an annual service has been carried out in accordance with the handbook.	7th SERVICE DATE: DEALER'S STAMP We certify that an annual service has been carried out in accordance with the handbook.

SERVICE INSPECTION

<p>8th SERVICE DATE: DEALER'S STAMP</p> <p>We certify that an annual service has been carried out in accordance with the handbook.</p>	<p>9th SERVICE DATE: DEALER'S STAMP</p> <p>We certify that an annual service has been carried out in accordance with the handbook.</p>
<p>10th SERVICE DATE: DEALER'S STAMP</p> <p>We certify that an annual service has been carried out in accordance with the handbook.</p>	<p>11th SERVICE DATE: DEALER'S STAMP</p> <p>We certify that an annual service has been carried out in accordance with the handbook.</p>
<p>12th SERVICE DATE: DEALER'S STAMP</p> <p>We certify that an annual service has been carried out in accordance with the handbook.</p>	<p>13th SERVICE DATE: DEALER'S STAMP</p> <p>We certify that an annual service has been carried out in accordance with the handbook.</p>
<p>14th SERVICE DATE: DEALER'S STAMP</p> <p>We certify that an annual service has been carried out in accordance with the handbook.</p>	<p>15th SERVICE DATE: DEALER'S STAMP</p> <p>We certify that an annual service has been carried out in accordance with the handbook.</p>

Caravan towing code	14
Caravan terms	14
Towing vehicle terms	15
Measurement of nose weight	16
Type of driving licence held	16
Glossary & checklist	16
Useful memory aid	18
Preparing for the road	20
Tyre Maintenance	22
The Tyre Law	24
13 Pin Socket	26
Breakaway Cables	27
Mirrors	28
Moving off	28
Reversing	28
Speed limits	29
Caravan handling	29
Motorway driving	29
AL-KO spare wheel carrier tips	29
Changing a wheel	30
Wheel Bolt tightening	30
Jacking points	30
Stopping on a hill	31
Arrival on site	31
Exterior Door	32
AKS 3004	32

CARAVAN TOWING CODE

This Code of Practice contains recommendations jointly reviewed and agreed by the following organisations:

The National Caravan Council
The Caravan Club
The Camping and Caravanning Club
The Caravan Writers Guild
The Department for Transport

Scope of the Code

The Code applies to all trailer caravans of maximum laden weight not exceeding 3500 kg (7,700 lbs), overall width not exceeding 2.3m (7ft 6in approximately) and overall length not exceeding 7m (23ft approximately), excluding the drawbar and coupling.

This is legally the maximum size of trailer that can be towed by a motor vehicle with a maximum gross weight of less than 3500 kg.

CARAVAN TERMS**Mass in Running Order:**

The mass of the caravan equipped to the caravan manufacturer, standard specification.

The MRO includes an allowance for gas, the electric hook up, cables as well as the fluids and liquids required for the normal caravan operation.

The mass of the caravan in running order contains provision for the masses of liquids, gas etc. (see Mass in Running Order in User Handbook). Part of this provision can also be utilised as additional payload, if for example, you wish to travel with water tanks empty or with no gas cylinders.

Maximum User Payload:

The maximum allowable weight to be put into the caravan whilst it is being towed. This is made up of the personal effects and the optional equipment payloads.

The user payload is the difference between the Maximum Technically Permissible Laden Mass and the Mass in Running Order.

The Mass in Running Order + Personal Effects + Optional Equipment = Maximum Technical Permissible Mass or MRO + PE + OE = MTPLM

Personal Effects

Those items which a user can choose to carry in a caravan.

Note: an allowance has been provided for in the Personal effects for a leisure battery weighing 20kg

Optional Equipment

Items made available by the manufacturer over and above the standard specification of the caravan for factory fitted options.

Maximum Technically Permissible Laden Mass (Lower Limit):

The fully laden mass of the caravan in the manufacturers standard specification which is stated in the publications, handbooks, brochures and weight plate and used for car matching.

Maximum Technically Permissible Mass (Upper Limit):

The mass takes into account specific operating conditions including factors such as the strength of materials, loading capacity of tyres, etc.

WARNING: Under no circumstances should the maximum technically permissible laden mass (MTPLM) be exceeded.

Upgrading of maximum technically permissible laden mass:

The lower (or standard) MTPLM is quoted in the Technical Handbook, in brochures and on the caravan weight plate. However, in some cases it may be possible to increase this to a higher (upper) MTPLM. (See Technical Handbook for details).

If extra user payload is required, an upgrade maybe available (model dependant), this must be requested via your dealer and is chargeable.

If required you will be issued with the following:

- (i) New weight plate giving upgrade weight details.
- (ii) New NCC certificate (declaring the upgraded MTPLM)

- (iii) Manufacturers letter confirming the upgrade for that Vehicle Identification Number.

Note: Tyre pressures may increase when upgrading.

Nose weight:

The vertical weight transferred to the towing vehicle through the coupling head.

Notes:

- (i) When measuring the noseweight it is important that the caravan is fully loaded. Do not place extra items indiscriminately into the caravan after this adjustment has been made.
- (ii) The caravan is intended to be towed slightly nose heavy. The nose weight can be adjusted by distribution of the load within the caravan. The nose weight should be approximately 7% of the actual laden weight (but not greater than the hitch capacity) and at the same time suit the towing vehicle. See section on Measurement of Nose Weight.
- (iii) It is not recommended that you tow with just a battery, spare wheel and gas bottles as this may exceed the permitted nose weight. Additional payload must be placed behind the axle to compensate for this.

TOWING VEHICLE TERMS**Kerb weight (Mass of Vehicle in Running Order):**

The weight of the towing vehicle as defined by the vehicle manufacturer. This is normally with a full tank of fuel, with an adequate supply of liquids incidental to the vehicles propulsion, without driver or passengers, without any load except loose tools and equipment with which the vehicle is normally provided and without any towing bracket.

Caravan to Towing Vehicle Weight Ratio:

The towing vehicle to caravan weight ratio can be determined by calculation and is equal to:

$$\frac{\text{Actual laden weight of caravan}}{\text{Kerb weight of towing vehicle}} \times 100\%$$

Kerb weight of towing vehicle

The law requires that caravans & their towing vehicles & the loads they carry must be in such a condition that no danger or nuisance is caused.

(Regulation 100 of the Road and Vehicles [Construction and Use] Regulations 1986).

Note: The towing vehicle manufacturer's limit is, in some cases, less than the kerb weight.

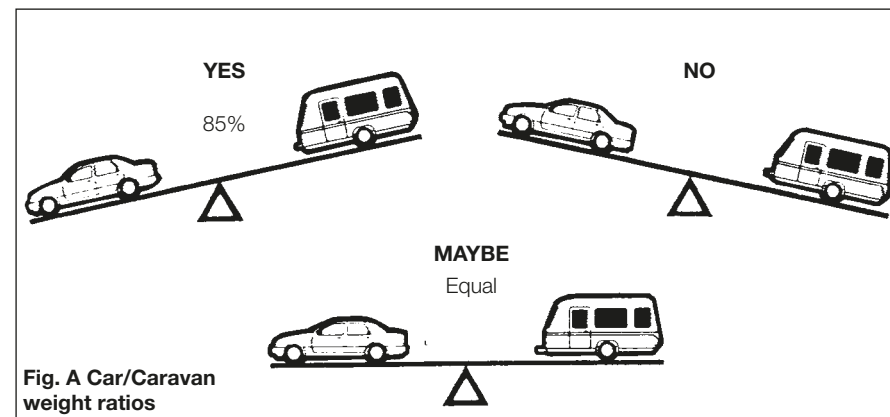

Fig. A Car/Caravan weight ratios

MEASUREMENT OF NOSE WEIGHT

Mass in Running Order:

Caravanners can use a public weigh bridge to establish the mass in running order.

Note: Weigh bridges have varying weight tolerance levels.

Maximum Permissible Towing Mass:

The weight defined by the vehicle manufacturer as being the maximum that the vehicle is designed to tow.

Train Weight (Combination Weight):

The maximum combined weight of the towing vehicle and trailer combination as specified by the towing vehicle manufacturer.

MEASUREMENT OF NOSE WEIGHT

Nose weight may be measured using a propriety brand of nose weight indicator. Such equipment is obtainable at your Caravan Dealer.

Note: These indicators have a varying tolerance level and may not be accurate.

Another simple method is to use bathroom scales under the coupling head with a piece of wood, fitted between the coupling head and the scales, of such length that the caravan floor is horizontal with the jockey wheel raised clear of the ground. (Fig. A)

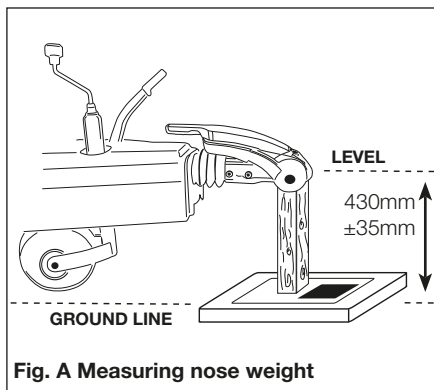

Fig. A Measuring nose weight

Nose weight can be adjusted simply by distribution of weights in the caravan.

Always lower jockey wheel before entering the caravan and then raise before measuring again. (See Loading).

Note: The height of the towball on the towing vehicle, when laden, is also critical.

WARNING: Do not lift the coupling head by hand when hitching the caravan to the car. Always raise and lower the coupling head by winding the handle on the jockey wheel up and down.

Driving licence

In order to be able to tow a caravan a driver must hold a Category B licence. Those car drivers who passed their tests prior to 1 January 1997 would have automatically obtained Category B+E. However, anyone who passed their test after 1 January 1997 will need to take a further test in order to obtain a Category B+E if they wish to tow a car and caravan combination whose train weight exceeds 3,500kg, or up to 4,250 if the caravan is less than 750kg or if the caravan's Maximum Technically Permissible Laden Mass exceeds the unladen weight of the car.

Note: The unladen weight of a car is normally less than the kerb side weight.

GLOSSARY & CHECKLIST

Awnings - Can consist of just a simple top sheet but may extend to a five sided frame tent attached to the side of the caravan.

Fire blanket - approved to BS 6575 is ideal for dealing with 'fat pan' fires.

Fire extinguisher - It is strongly recommended that a fire extinguisher is carried in the caravan. (For suitable types see Safety and Security).

Gas bottles - Bottled L.P. gas is the most convenient portable source of fuel. Two bottles are required for a constant supply.

An initial deposit is payable on each cylinder. We recommend the use of 6kg Calor Light Propane bottles. One position for use and one for storage only. (For detailed information see Services - Gas).

Jack - A suitable jack is essential (screw, scissor, side mounted or air jack type). Many car jacks are unsuitable.

Levellers - Levellers help level the caravan from side to side before unhitching. Proprietary products can be purchased from your caravan dealer and need to be positioned as indicated by a spirit level.

Spare Wheel - It is always advisable to carry a spare wheel with your caravan.

Spirit Level - A spirit level is extremely useful when siting the caravan.

Stabiliser - Stabilisers help to dampen the side to side movement of the caravan.

Torque Wrench - A torque wrench is the only way that the exact recommended torque can be achieved for wheel nuts and bolts. (See Preparing for the Road).

Towing Bracket - Never use cheap alternatives, obtain one manufactured by a reputable company complying with the relevant standards.

Any light passenger vehicle registered in the UK on or after August 1st 1998 will require a type approved towbar and towball (to 94/20/EC). Failure to fit a homologated towbar and towball could result in a prosecution and invalidation of your insurance cover. Always check with your car manufacturer or towbar manufacturer if in doubt.

Wooden Blocks - Wooden blocks typically 25cm square and 2cm thick are ideal for placing under corner steadies and jockey wheel when the ground is uneven or soft.

Water Containers - Two containers are required, one to carry fresh water to the caravan and one for waste water, which needs to be disposed of properly. Several types are available including jerry cans, Aquarolls, wastemaster, etc .

13 Pin Socket - One socket fitted to the

GLOSSARY AND CHECKLIST

car to accept corresponding plugs from the caravan this energises the road lights and caravan auxiliary circuits.

12 Volt Battery - A deep cycling, heavy duty rechargeable leisure type battery should be purchased to provide back-up power for lights and other electrical appliances. (See Battery). The securing arrangements for the battery compartment require a leisure battery complying with EN 60095-2 in particular those with ledges for fastening to the lower edge of the long sides. The maximum battery size that can be fitted is 225mm high, (including terminals) x 175mm deep x 353mm wide. The depth and width dimensions include the rim around the bottom used for securing the battery.

Note: Batteries that are not foot mounted, ie. without a rim, can still be fitted, but check first that they will fit within the battery box and can be secured before purchasing.

WARNING: Your caravan dealer should be consulted if additional equipment is to be fitted as strong points may or may not be provided in the design.

Note: Fitting additional equipment, such as a motormover will reduce the caravan allowable payload.

Note: The fitting of a motormover may require a larger capacity battery fitting.

Note: We do not recommend towing with towing covers fitted as these can obscure lights/reflectors and may rub or damage the bodywork.

USEFUL MEMORY AID**Car**

External mirrors
 Fire extinguisher
 Jack
 Petrol can
 Spare bulbs
 Spare keys
 Spare wheel
 Tool kit
 Towball cover
 Tyre pressure gauge
 Warning triangle
 Tyre Pump

Caravan

Awning pegs and poles
 Awning ground sheet
 Bucket
 Corner steady brace
 Corner steady pads
 Coupling lock
 Door mat
 Fire blanket
 Fire extinguisher
 Fresh water container
 Gas cylinders
 Jack
 Levelling boards
 Mallet
 Site/caravan mains lead
 Spare bulbs (Mandatory in E.C.)
 Spare 12v fuses
 Spare high pressure gas hose
 Spare wheel
 Spirit level
 Toilet fluid
 Waste water container
 Wheel brace

Personal

After sun cream
 First Aid Kit
 Flannels
 Hairbrush and comb
 Make up. etc.
 Raincoats
 Toothbrush
 Toothpaste
 Scissors

Shampoo
 Shaving kit
 Shoe cleaning kit
 Soap
 Sun tan oil
 Wellington boots

Domestic

Adhesive tape
 Air freshener
 Aluminium foil
 Ashtrays
 Bedding
 Bin liners
 Binoculars
 Bottle opener
 Breadboard
 Brush and dustpan
 Butter dish
 Camera
 Carving knife
 Chairs
 Clock
 Clothes brush
 Clothes line
 Coat hangers
 Coolbox
 Colander
 Crockery
 Cruet
 Corkscrew
 Cutlery
 Dish cloth and brush
 Dusters and polish
 Disposable cloths
 Egg cups
 Floor cloth
 Fly spray
 Food
 Food mixer
 Frying pan
 Glasses
 Grill pan
 Jugs
 Kettle
 Kitchen roll
 Kitchen tools
 Matches
 Measuring jug
 Milk jug
 Mixing bowl

Needles and thread
 Oven gloves
 Pegs
 Piezo Gas lighter
 Potato peeler
 Radio
 Rubbish bin
 Saucepans
 Scissors
 Sieve
 Sugar bowl
 Shopping bags
 Sleeping bags
 Tea pot
 Tea strainer
 Tea towels
 Table cloths
 Table mats
 Television
 Tin opener
 Tissues
 Toilet paper
 Torch
 Towels
 Toys & Games
 Vacuum cleaner
 Washing up bowl

Documents

Bank and credit cards
 Caravan Certificate
 Cheque book
 CRIS document
 Driving licence
 Green Card
 Insurance (some Euro countries)
 Maps and guides
 Money
 MOT Certificate
 Vehicle Registration Documents

PREPARING FOR THE ROAD

PREPARING FOR THE ROAD

PRE-LOAD CHECKLIST

Caution: Never enter the caravan without first lowering the four corner steadies with the brace provided.

BEFORE LOADING CHECK:

- loose articles are stowed securely. Do not stow tins, bottles or heavy items in overhead lockers prior to towing.
- all lockers and cupboard doors are closed and secured, including the bathroom door.
- all bunks are secure.
- ensure shower door is secure
- all rooflights are closed and secured.
- main table is stored in its transit position.
- television aerial is lowered
- fridge is on 12V operation and door lock is set.
- all windows are fully closed and latched. Never tow with windows on night setting. Leave all curtains and blinds open to aid rear visibility.
- gas cylinders are correctly positioned, secured and turned off.
- battery is secure and mains connecting cable is disconnected and stowed.
- Ensure control panel settings are correct for 12v fridge operation. See control panel instructions for detail.

WARNING: Turn off gas appliances.

WARNING: Do not travel with televisions or microwaves in overhead lockers unless the appliance was supplied fitted to your caravan by the manufacturer.

WARNING: Always disconnect the electrical connector between the towing vehicle and the caravan before connecting a LV supply to the caravan.

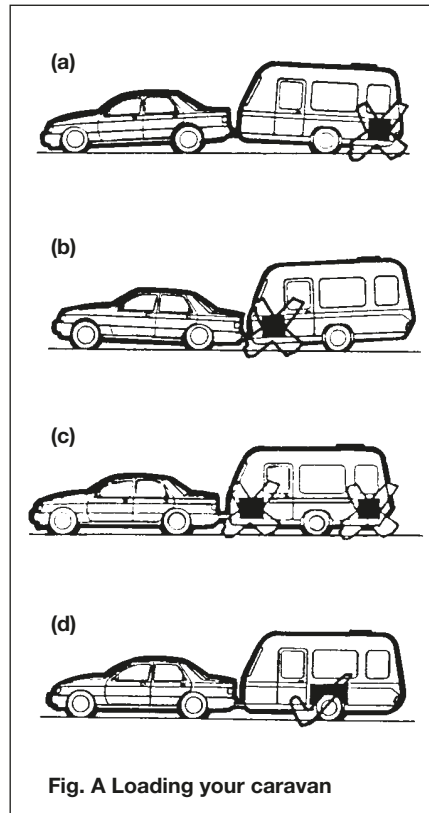

Fig. A Loading your caravan

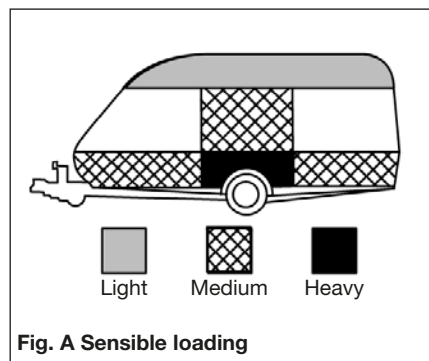

Fig. A Sensible loading

How to apportion it

1. Load heavy items low down near the floor and mainly over or just in front of the axle(s) (Fig. A).

2. Load evenly right to left so that each caravan wheel carries approximately the same weight.
3. Do not load items at the extreme front or rear since this can lead to instability due to the 'pendulum effect'.
4. Load remainder to give a suitable nose weight at the towing coupling.

Check nose weight.

Note: Do not overload car boot.

WARNING: All heavy and/or voluminous items (e.g. TV, radio etc) must be stored securely before travelling.

PLEASE TAKE CARE TO ENSURE THAT YOU HAVE ALLOWED FOR THE MASSES OF ALL ITEMS YOU INTEND TO CARRY IN THE CARAVAN. e.g. optional equipment, and personal effects such as clothing, food, pets, bicycles, sailboards, sports equipment etc.

WARNING: UNDER NO CIRCUMSTANCES SHOULD THE MTPLM OF THIS CARAVAN BE EXCEEDED

Towing vehicle's rear suspension

It is important that the towing vehicle's rear suspension is not deflected excessively by the nose weight on the tow ball. If it is excessive the steering and stability will be affected. (Fig. B)

The greater the towing vehicle's tail overhang (the distance between the rear axle and the tow ball), the greater the effect the nose weight will have on the towing vehicle's rear suspension.

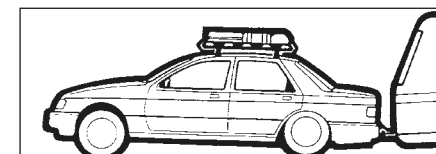

Fig. B Illustration of excessive deflection of vehicle's rear suspension

After trying out the caravan it may be found that a stiffening of the rear suspension is necessary - but note that this may give the towing vehicle a firmer ride when not towing.

There are a number of suspension aids available and advice should be sought on which to use and how to fit. It is important to ensure that the caravan is towed either level or slightly nose down.

If you have any doubts about the suitability of your towbar for towing a caravan consult the towing bracket manufacturer.

DO NOT exceed the:

- Gross Vehicle Mass (G.V.M. on car plate).
- Maximum Technically Permissible Laden Mass (M.T.P.L.M.) on the caravan.
- Gross Vehicle Combination Mass (Train Weight) (G.V.C.M. on car plate).
- Maximum Permissible Towing Mass.
- Vertical Static Load on the caravan coupling (noseweight).
- Maximum Vertical Load on the car towball as specified by towing vehicle manufacturer (noseweight).
- Driving licence limitations

Stability

All our models are of a well balanced design and should be exceptionally good towers. Most models have an AL-KO stabiliser fitted as standard. The common causes of poor stability include:

- (a) Worn springs or loose spring fixings on the towing vehicle.
- (b) Towing vehicle springs too soft.
- (c) Insufficient nose weight.
- (d) Nose of caravan is towing too high.
- (e) Unsuitable towing vehicle

Galvanised steel chassis

Drilling of the galvanised steel chassis will invalidate the warranty and must not be done.

PREPARING FOR THE ROAD

Towball

The AL-KO stabiliser is designed to be used with a swan neck, fixed or detachable towball. If you use a 'bolt on type' towball you may need to replace your towball with a special extended neck towball.

If you have a bolt on type towball you should ask your dealer to check clearance around the towball to allow for the stabiliser to articulate.

The AL-KO extended neck towball (available from your dealer) is approved and marked with the approval number EC94/20. Failure to provide enough clearance around the towball may invalidate your stabiliser warranty.

Stabiliser friction pads

The AL-KO stabiliser uses 'friction pads' inside the coupling head to clamp the towball. These pads must be kept free from grease and contamination from the towball.

The friction pads should last approximately 50,000km (30,000 miles) under normal use, if correctly maintained.

Suitable towing vehicles

The caravan is manufactured for towing behind normal road cars and is not suitable for towing behind commercial vehicles. It is strongly recommended that whenever a caravan is to be towed over rough terrain, e.g. a field or track, great care should be taken to ensure that no undue stress is placed upon the caravan via the hitch mounting, i.e. reduce speed. If in doubt, please consult the chassis manufacturer and the towing vehicle manufacturer who will advise. Touring caravans based on standard AL-KO chassis can be towed by four wheel drive off road leisure vehicles providing the unit is used to tow in a like manner to a conventional road-going car and driven in the same considered manner.

Towbar manufacturers should be consulted before towing an uncompensated twin axle caravan.

Snaking

This is a term used to denote an unstable car and caravan combination where the caravan

'weaves' from side to side often causing a similar swaying movement in the car itself.

Causes:

- i) Unsuitable or unbalanced outfit.
- ii) Incorrect loading or weight distribution.
- iii) Excessive speed especially downhill.
- iv) Side winds.
- v) Overtaking.
- vi) Being overtaken by a large fast moving vehicle.
- vii) Erratic driving.
- viii) Insufficient tyre pressures.

Cures:

Cases of persistent snaking can be alleviated by the use of a stabiliser.

On the road

If you do find your outfit snaking, try to keep the steering wheel in a central position as far as possible, decelerate and avoid braking if possible.

Types of tyres fitted

The original tyres fitted by the manufacturer are suitable for towing at maximum speed of up to 81 mph (130 kph).

Tyres

Caravan manufacturers choose the type, size, profile, load carrying capacities and speed ratings to match the design masses of these vehicles, adjusting the tyre pressures to suit. Only change the type of tyres on your caravan on expert advice from the caravan manufacturer, or tyre manufacturer.

TYRE MAINTENANCE**Tread depth**

Pay special attention to the amount of tread remaining on your tyres, and measure them regularly. Always replace tyres before they reach the minimum legal limit of 1.6mm.

Periodically tyres should be rotated to equalise wear in the same manner as car tyres.

Pressures

The caravan manufacturers plate (fixed adjacent to exterior door) and Technical handbook contains information about caravan loading and the required adjustments to tyre pressures, which should be followed for safety. Tyre pressures should always be checked and corrected prior to each journey. It is vital that tyre pressures are maintained at the levels recommended by the manufacturer to ensure maximum tyre life, safety and handling characteristics.

Over or under-inflating tyres is likely to seriously impair their performance and may prejudice the safe use of the vehicle.

Over-inflation increases overall tyre diameter, decreases the amount of tread in contact with the road, decreases sidewall flexibility and affects road-adhesion.

Under-inflation decreases overall tyre diameter, increases sidewall flexing, generates higher tyre operating temperatures and difficult vehicle handling characteristics. Running an under-inflated tyre may cause premature tyre failure. Both over and under-inflation adversely affect tyre life.

Treads

Keep tyre treads clean of stones and other foreign bodies, and check regularly for damage to the tread and sidewalls. It is vitally important that any damage is checked out by a tyre expert and any necessary repairs or replacements are carried out immediately.

Tyre valves

Check tyre valves carefully. Ensure the caps are in place free from dirt/ debris and that there is no evidence of cracking or damage to the valve stem.

Tyre aging

Rubber compounds used in tyres contain chemicals that help to slow down the natural aging process of untreated rubber. However, tyres do deteriorate with age, which increases the risk of tyre failure, and there are many ways in which this can be spotted:

- Cracking/crazing on the side wall of the tyre, caused by its flexing
- Distortion of tyre tread
- Deformation of the carcass of the tyre

There will also be a deterioration of the ride quality caused by vibrations through the tyre. This may signify the tyre performance has been affected by age and should be investigated as soon as possible

It is recommended that tyres are replaced after 5 years

Tyres that display signs of aging should be removed and not put to further use.

The effects of aging can be brought about prematurely in several conditions. Tyres fitted as spare wheels may age prematurely. If tyres on caravans are not in regular use they should be inspected before every journey, several cleaning products may also harm the chemicals in the rubber. However, the age of a tyre will affect its safety and increase the risk of failure, and you should inspect tyres for the signs of aging regularly.

The use of some motor movers can damage or increase wear on the tyres prematurely.

PRE-TOW CHECK LIST

THE TYRE LAW

PLEASE NOTE: Sales literature/ Technical Handbooks publish recommended tyre pressures for the MTPLM only (fully laden condition). It is not possible to publish tyre pressures for any other load condition other than the MTPLM.

Tyre types

It is illegal to mix tyres of a different construction on the same axle.

Note: Although the caravan may be fitted with the same type of tyre as the towing vehicle, the pressures specified are different. All charts show values for cars and are therefore not applicable for caravans.

Pressures displayed on tyre walls apply ONLY in North America and Canada.

Wheels

Caravan wheel bolts should be tightened to a torque of 88Nm (65lb/ft) on steel wheels or 130Nm (96lb/ft) on alloy wheels and should be checked with the use of a torque wrench regularly. Only use a spare wheel and tyre of the type and size provided with you caravan.

NOTE: Please remember to check the wheel bolt torque setting regularly.

Wheel rims

Two sizes of wheel rims are used 5.5J x 14 and 6J x 15, the rim sizes are the same for both steel and alloy rim, incorporating a double safety hump which conforms to European safety standards. Check the size on your caravan before replacing a rim.

Hitch head load capacity

The maximum vertical static load which can be put upon the hitch head when connected is 100kg. Please refer to the technical data in your handbook. (But see also vehicle manufacturer's weight limits on towball loading.)

PRE-TOW CHECKLIST AND HITCH-UP FOR AKS 3004 STABILISER

Fig. A

Check gas locker, battery locker and cassette toilet doors are secure.

Check wheelnuts, tyre pressures and tyre conditions.

Fully raise all four corner steadies. (Fig. A).

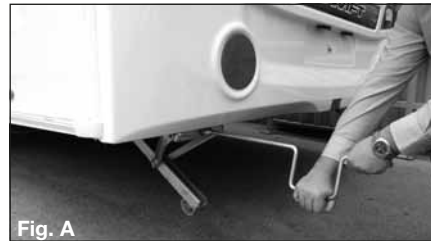
Pick up any levelling pads or levelling boards.

Check rooflights/vents are securely closed.

Ensure television aerial is lowered.

Switch off gas supply and change over to 12v electricity if required.

Lock the caravan exterior door.



Fig. B

An assistant can help in the hitching operation by standing on the left hand side of the drawbar (facing rear of car) and extending an arm horizontally to indicate position of the coupling. When reversing aim the towball of the car directly at the caravan drawbar. Remove towball cover and keep in car.

Adjust the jockey wheel to ensure the cup is high enough to slide over the towball.

Release caravan handbrake.

Position cup over the ungreased towball, release and lift forward the large red stabiliser handle (Fig. B) lift forward the exposed smaller black handle (Fig. B) until it clicks up.



Fig C

The hitch head is fitted with a visual indicator to show whether or not it is properly connected to the towball. A green band will show immediately below the red indicator button on the hitch head when a proper connection has been made. (See Fig. C)

Adjust jockey wheel to lower cup on to the ball. A click indicates it is fully engaged. Ensure black handle has returned to its free position.

Secure caravan handbrake. (Fig. D)



Fig. D Handbrake

Connect breakaway cable as described on page 27.

Ensure that the jockey wheel is fully wound up and properly located in the slots in the jockey wheel tube, then release the clamp handle, lift the whole unit as high as possible ensuring the wheel is pointing directly backwards and retighten the clamp handle.

Note: Ensure jockey wheel locates in recess provided. Carelessness could result in damage to the A frame cover.

Ensure the hitch is secured by checking the visual indicator (figure C).

WARNING: If the green band is showing when the hitch head is not connected to the towball there is a fault - contact your Dealer.

Connect the 13 pin plug to car socket by inserting and rotating slightly ensuring there is enough loose cable for cornering, ensuring they won't drag on the ground.

Check all car and caravan roadlights are working. Check round the caravan for anything left behind.

Fit extending mirrors

Release caravan handbrake, adjust all mirrors from driving seat and proceed.

- All road lights must be in working order.
- Lenses and reflectors must be in good condition
- Bulbs must be of correct wattage for the application (see Service handbook).

WARNING: Do not cause any road lighting to be obscured by the addition of any options or accessories to your caravan.

13 PIN SOCKET

13 PIN SOCKET

Please be aware that some car manufacturers and towbar manufacturers do not wire up all 13 pins as standard, unless requested.

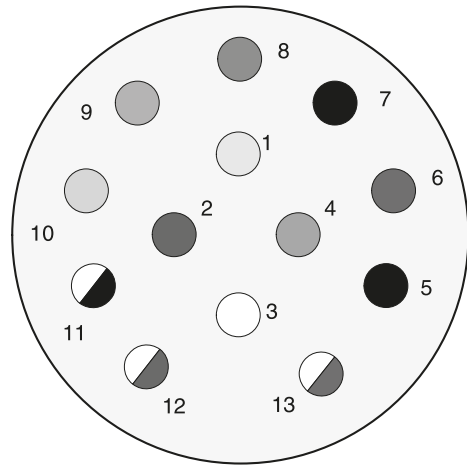

11446 Plug Connector viewed from cable entry on plug

Pin No	Core Colour	Core Size	Function
1	Yellow	1.5	Left Hand Indicator Light
2	Blue	1.5	Rear Fog Warning Light(s)
3	White	2.5	Earth for pins 1 - 8
4	Green	1.5	Right Hand Indicator Light
5	Brown	1.5	Right Hand Tail Light
6	Red	1.5	Brake Lights
7	Black	1.5	Left Hand Tail Light
8	Pink	1.5	Reverse Light(s)
9	Orange	2.5	Car +ve
10	Slate (Grey)	2.5	Fridge +ve
11	White/Black	2.5	Earth for pin 10
12	White/Blue	1.5	Not Yet Allocated
13	White/Red	2.5	Earth for pin 9

BREAKAWAY CABLE

Passengers

Passengers are forbidden to ride in a caravan.

BREAKAWAY CABLES

UK law requires that all caravans are fitted with a safety device to provide protection in the unlikely event of separation of the main coupling while in motion. A device referred to as a 'breakaway cable' fulfils this requirement and when fitted as on your caravan is mandatory.

Purpose

To apply the caravans brakes if it becomes separated from its towing vehicle. Having done this, the cable assembly is designed to part allowing the caravan to come to a halt away from the towing vehicle.

Identification

A thin steel cable with a red plastic coating fitted with a means of attachment for connection to the towing vehicle. Located directly beneath the coupling head.

Operation

In the event of the main coupling of the caravan separating from the towing vehicle, the cable should be able to pull tight, without any hindrance, engaging the caravan brakes. The breakaway cable should not become taut during normal driving.

Correct procedure for use

Regularly check the cable and clip for damage. If in doubt contact your Swift Group dealer.

Make sure the cable runs as straight as possible and goes through the cable guide fitted underneath the caravan coupling head.

Determine whether or not the towing vehicle towbar has a designated attachment point (i.e. a part specifically designated for a breakaway cable).

Where a point is designated on the towbar:

- Pass the cable through the attachment point and clip it back on itself (figure 1).

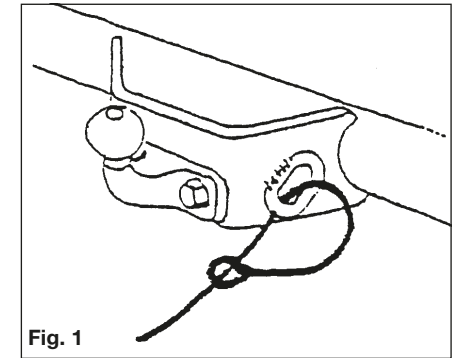

Fig. 1

- Do not clip directly onto the designated point (figure 2) since the clip is not designed for use in this way.

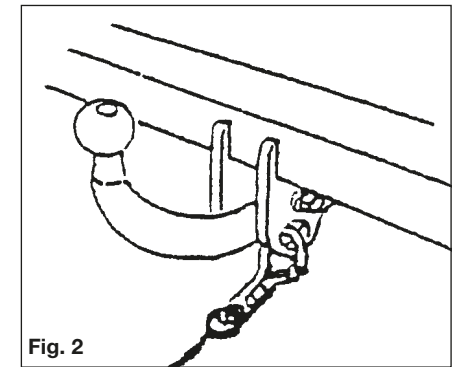

Fig. 2

Where there is no designated attachment point on the towbar:

- Fixed ball: Loop the cable around the neck of the towball in a single loop only. See figure 3A and 3B.

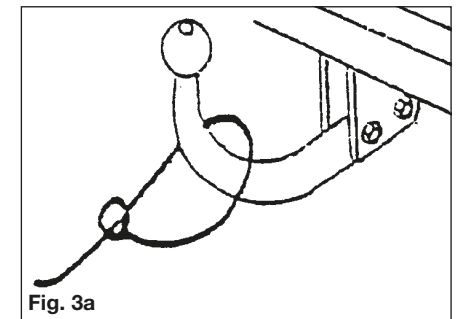

Fig. 3a

MOVING OFF

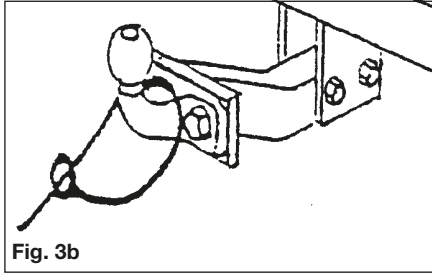

Fig. 3b

- Detachable towball: You must seek guidance on procedure from the towing vehicle towbar manufacturer or supplier.

When the breakaway cable is attached, check:

- that the cable cannot snag in use on the caravan coupling head, jockey wheel, stabiliser or accessory e.g. bumper shield, cycle carrier etc.
- that there is sufficient slack in the cable to allow the towing vehicle and caravan to articulate fully without the cable ever becoming taut and applying the brakes.
- that it is not too slack and can drag on the ground. If left loose, the cable may scrape along the ground and be weakened so that it subsequently fails to do its job. The cable may also be caught on an obstacle when in motion thus engaging the caravan brakes prematurely.

MIRRORS

The driver of the towing vehicle must have an adequate view of the rear.

If there is no rear view through the caravan it is essential that additional exterior towing mirrors are fitted. This is mandatory in some European countries and drivers can face instant fines if extension mirrors are not fitted.

Caution: Any rear view mirror must not project more than 250 mm outside:

- the width of the caravan when being towed.
- the width of the towing vehicle when driven solo.

Note: Any rear view mirror fitted shall be 'e' marked and cover the field of view as stipulated by type approval requirements (Community Directive 2003/97 or 2005/27 or ECE Regulation 46.02 or Regulation 33 of the Road Vehicles (Construction & Use Regulation 1986).

MOVING OFF

Let the clutch in smoothly.

Allow more engine speed to produce the power to move the additional weight of the caravan.

Reduce wear and tear on clutch and transmission by taking extra care.

Change gears smoothly.

Try not to jerk the clutch.

REVERSING

When the towing vehicle is reversing, the overrun device shaft is pushing in, applying the brakes via the overrun lever, brake rod system, bowden cables and the expander mechanism.

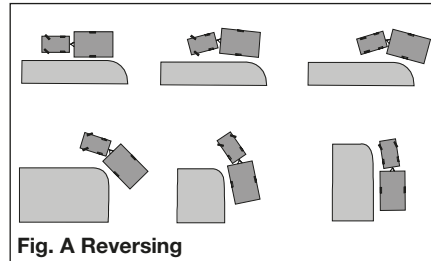

Fig. A Reversing

The backwards rotation of the brake drum causes the secondary brake shoe to collapse cancelling out the braking effect, allowing the caravan to move backwards. At the same time the transmission lever swings back and compensates for the entire travel.

When reversing up a slope or on a loose surface the brakes may apply themselves. Correct maintenance and set up of the brakes will help prevent this. Incorrect adjustment of the wheel brakes or linkages will result in making reversing difficult.

Proficiency at reversing can only be achieved with practice and should be first attempted in a large open area (Fig. A).

SPEED LIMITS

Normal road towing: 50mph

Motorways (including dual carriageways): 60mph

CARAVAN HANDLING

Allow for caravan being wider than car.

Do not bump kerb with caravan wheels.

When passing other vehicles allow more than the normal clearance for driving solo.

Allow longer to get up speed to pass.

Allow for the outfit being twice its normal length.

Do not suddenly swing out.

Carry out all manoeuvres as smoothly as possible.

Use nearside wing mirror to check caravan has cleared when overtaking.

WARNING: Take care not to foul or ground caravan chassis whilst traversing ramps or other obstacles.

MOTORWAY DRIVING

Important points

- Caravans may not be towed in the outside lane of a three or four lane motorway. (Reg. 12(2) of the Motorway Traffic [England and Wales] Regulations 1982).
- Reduce Speed:
 - In high or cross winds
 - Downhill
 - In poor visibility
- High sided vehicles cause air buffeting so extra care must be taken when passing or being passed. As much space as possible should be given.

SPARE WHEEL CARRIER

ALKO SPARE WHEEL CARRIER TIPS

The caravan needs to be jacked to the maximum lifting height to be able to withdraw the wheel from the carrier.

NOTE: The side-lift jack has a maximum lifting height of 375mm and the scissor jack a maximum lifting height of 340mm.

- Customers should also ensure that the telescopic arms are kept well greased at all times to guarantee ease of operation.

IMPORTANT NOTE: if it becomes necessary to completely remove the carrier from the chassis remember that the washers and split pins are on the inside of the chassis as well as the outside.

CHANGING A WHEEL

CHANGING A WHEEL

1. Leave caravan hitched to towing vehicle and ensure that the caravan and towing vehicle handbrakes are applied.
2. Lower corner steadies (as safety measure) on the side that is being jacked up.
3. Remove wheel trims (if fitted).
4. Use wheel brace to slacken off wheel nuts on the wheel to be changed.
5. Position jack under the axle at the appropriate jacking point (see Fig. B, page 31)
6. Jack up the caravan until the wheel for removal is just off the ground.
7. Remove the wheel nuts and remove the wheel.
8. Fit spare wheel and reverse the above procedure. Ensure clean, dry mating surfaces and clean, dry bolt/nut sealing areas.
9. Tighten all five bolts, according to Fig. A, to 88Nm (65lb/ft) for steel wheels or 130Nm (96lb/ft) for alloy wheels using a torque wrench or have checked as soon as possible. Ensure the correct wheel fixings are used, as supplied with your caravan.

IMPORTANT

When a wheel has been removed and replaced the torque of the wheel nuts should be re-checked regularly.

Wheel Bolt Tightening

When refitting a wheel it is ESSENTIAL that the wheel bolts are tightened to the recommended torque figure and in the correct sequence.

The sequences necessary to correctly carry out this work on a 5 stud wheel is as follows:

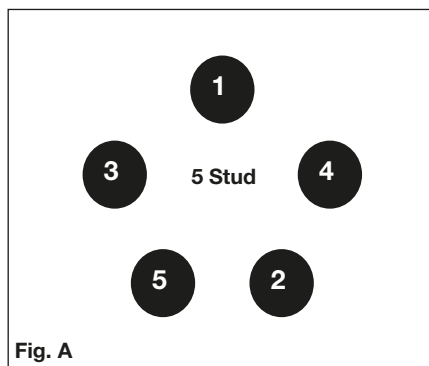

Fig. A

Please note the correct torque settings

Jacking points

WARNING: Only jack up your caravan when it is coupled up to the car with its handbrake applied and in 1st gear (engine off).

Ensure that the jack is located in the correct position, i.e. on the jacking bracket on the chassis for the AL-KO side mounted jack (Fig.B). Alternatively the reinforced axle mounting plate can be used as an alternative but the chassis member itself MUST NEVER be used as a jacking point.

All caravans are provided with the facility to fit AL-KO side jacking points and although a scissor, trolley or bottle jack may be used.

SELECTING PITCH

1. Selecting a pitch

Do not pitch in such a position that your outfit will obstruct others coming in.

Try to choose an area which is dry, reasonably level and preferably with a hard base.

If you have no alternative but to pitch on a slope ensure that, for when you leave, you are facing down the slope.

It is good practice to chock the wheels of the caravan when parked on a slope even though the caravan brakes are applied.

2. Levelling the caravan

Levelling must be carried out in both directions in order for the refrigerator and other equipment to function correctly. This should be done before unhitching the caravan. Levelling boards (Fig. C) can be used to raise one side of the caravan by driving or reversing the caravan onto the boards. Apply the handbrake and chock the wheels.

The positioning of the jockey wheel can be used to help level the caravan.

Lower the corner steadies until they are in firm contact with the ground.

DO NOT use the steadies as a jack they are only a means of stabilising the caravan.

Levelling pads or boards should be used under the steadies where the ground is soft or uneven.

In extreme cases where it is necessary to raise a wheel off the ground for levelling purposes, further adequate support should be applied so that the steadies do not take any undue strain.



Fig. B Side lift jack

Stopping on a hill

Pulling off again can sometimes present a problem. The easy solution is

- (i) Carry a good sized wedge shaped piece of wood with a rope or light chain attached.
- (ii) Attach the other end of the rope to the nearside rear grab handle.
- (iii) Place the wood behind the nearside caravan wheel.
- (iv) Carefully reverse the car slightly back down the hill, the caravan will stop against the wedge and turn.
- (v) Drive forward since this attempt to move up the hill will now not involve pulling the full weight of the caravan until the car has gained some traction.
- (vi) When reaching the top of the hill retrieve the wedge.

Arrival on site

Note: Check and observe site regulations.

Manoeuvring your caravan by hand

Note: Care must be taken when manoeuvring your caravan into position. Pressure placed on unsupported parts of front and rear GRP/ ABS panels may cause surface damage/ cracks to appear. Use the grab handles provided.



Fig. C Levelling board

Exterior Door

To prevent distortion of the body, the caravan must be always correctly sited and levelled. Failure to site the caravan correctly may prevent the exterior door from closing properly.

3. Unhitching

Apply the caravan handbrake.

Lower the jockey wheel to the ground.

Disconnect the breakaway cable and road lighting plugs.

AKS 3004

Release the stabiliser by lifting the red handle. Then lift the exposed black handle forward until it clicks up, at the same time winding down the jockey wheel, to lift the caravan clear of the towing vehicle.

Fire	34
SI 601 Smoke Alarm Operation	34
Alarm Test	35
Escape paths	36
Children	36
CO Alarm - Fireangel CO-9X Carbo Monoxide Alarm operation	37
Sensor Testing	38
Maintenance	38
Ventilation	39
Security	39
AL-KO secure immobiliser	40

FIRE AND FIRE ALARM

FIRE

Important: Your attention is drawn to the notice affixed inside the caravan wardrobe advising on fire precaution, ventilation and what to do in case of fire.

IN CASE OF FIRE

1. Get everyone out of the caravan as quickly as possible using whichever exit is the quickest, including windows. Do not stop to collect any personal items.
2. Raise the Alarm. Call the Fire Brigade.
3. Turn off the gas supply valve if it is safe to do so.
4. Turn off the electricity supply at supply point.

MODEL- SI 601 SMOKE ALARM OPERATION

Normal condition

The red LED on the front should flash once every 40 seconds to show the alarm is active.

Low Battery Condition

IMPORTANT: Your smoke alarm requires a battery with a sufficient capacity of power to operate correctly. This must also be correctly installed.

Should your smoke alarm enter a low battery condition, the unit will emit an audible 'chirp' once every 40 seconds. When this occurs you must replace the battery immediately. Your smoke alarm will continue to warn of this low battery condition for at least 7 days, however, failure to change the battery after this time would mean your smoke alarm has insufficient power to alert you in a real fire situation.

BATTERY REPLACEMENT

IMPORTANT: Only the following batteries can be used for replacement. Use of a battery other than those recommended below may have a detrimental effect on the detector's operation. Use of a lithium (long-life) battery could provide power for 10 years under normal operating conditions, meaning there is no need for an annual battery change.

NOTE: The alarm cover can't be installed without a battery fitted.

NOTE: Upon delivery the battery may be fitted with a protective cover. Please ensure this is removed before use.

Carbon-Zinc type:

Eveready Energizer 1222;
Gold Peak 16045 (UL).

Alkaline Type:

Energizer 522; Duracell MN 1604; Duracell 9V
Ultra; Energizer 9V Ultra+; Gold Peak 1604A.

Lithium (long life) type:

Ultralife U9VL

1. Remove the alarm from its mounting plate by turning anti-clockwise



2. Remove the existing battery and replace with a new battery. From the list on the previous page, making sure that the positive and negative connections are in the correct position. If unsure see the alarm user manual.



3. Replace the alarm on its mounting plate, lining up the large central vent on the front of the alarm, with the 'X' that is moulded into the plastic on the mounting plate (if unsure see page 13 of the alarm user manual). Ensure the unit is securely fitted.



4. Test your alarm as explained in the next section 'Alarm Test'.

FIRE ALARM

ALARM TEST

1. Press the test button in the centre and release.



2. The unit will emit a loud (85dB at 3 meters) alarm for around 5 seconds and stop automatically.



3. The red LED on your alarm will flash rapidly during the audible signal.



FIRE ALARM

NOTE: The test button accurately tests the alarm's smoke sensing circuit, there is no need to test your alarm with smoke. If your smoke alarm fails to give an audible test signal, please refer immediately to the troubleshooting guide at the end of the alarm user manual.

WARNING: Test your smoke alarm at least once per week

Your smoke alarm has been designed to be as maintenance - free as possible and although the unit requires only battery maintenance for its entire life, there are several things you must do to keep it working properly.

CAUTION: Your smoke alarm is a sealed electrical device and no attempt should be made to open the case. Attempting to open the case will invalidate your Warranty.

TESTING: Test your smoke alarm once every week, see page 35 on how to do this.

CLEANING: As a minimum your smoke alarm should be cleaned once every 3 months using your vacuum cleaner fitted with the soft brush attachment.



WARNING: Your smoke alarm may false alarm when it is being cleaned using a vacuum cleaner.

IMPORTANT: Do not use solvents or cleaners on your smoke alarm, as they may cause damage to the sensor or circuitry. The unit can be wiped with a slightly damp cloth.

Warning: The electronic test button provides a full test of the unit's functionality. DO NOT try to test the alarm with a naked flame, as this may present a potential fire hazard.

WARNING: Never use portable cooking or heating equipment other than electric heaters that are not of the direct radiant type, as it is a fire and asphyxiation hazard.

WARNING: Appliances such as cookers must not be used for heating.

Fire Extinguisher

It is recommended that a dry powder fire extinguisher be carried inside your caravan at all times.

When using a dry powder extinguisher it is suggested that the caravan be evacuated until the powder has settled, to avoid inhalation.

A fat pan fire should not have a fire extinguisher aimed at it. It should be smothered with a fire blanket.

WARNING: Provide one dry powder fire extinguisher of an approved type or complying with ISO 7165, of at least 1kg capacity, by the main exterior door and a fire blanket next to the cooker.

Familiarise yourself with the instructions on your fire extinguisher and the local fire precaution arrangements.

Escape paths

It is important that you do not block escape paths to emergency exits with obstructions or hazards.

Children

Do not leave children alone in the caravan in any event. Keep potentially dangerous items out of reach, as at home e.g. matches, drugs etc.

CO ALARM

CO ALARM

Fireangel CO-9X Carbon Monoxide Alarm

WARNING: Please read the full user instructions provided.

CARBON MONOXIDE

Known as the silent killer, Carbon Monoxide is an invisible, odourless and tasteless gas.

What are the symptoms of carbon monoxide poisoning?

Early symptoms of carbon monoxide (CO) poisoning can mimic many common ailments and may easily be confused with flu or simple tiredness. Symptoms to look out for include:

- tiredness
- drowsiness
- headaches
- giddiness
- nausea
- vomiting
- pains in the chest
- breathlessness
- stomach pains
- erratic behaviour
- visual problems

Anyone with these symptoms should immediately turn off all appliances and seek medical attention.

WHAT TO DO DURING AN ALARM

- Keep calm and open the doors and windows to ventilate the caravan.
- Stop using all fuel burning appliances and ensure, if possible, that they are turned off.
- Evacuate the caravan leaving the doors and windows open.
- Do not re-enter the caravan until the alarm has stopped. When exposed to fresh air it can take up to 10 minutes for the sensor to

clear and the alarm to stop depending on the level of carbon monoxide detected.

- Get medical help immediately for anyone suffering the effects of carbon monoxide poisoning (headache, nausea), and advise that carbon monoxide poisoning is suspected.
- Do not use the appliance again until it has been checked by an expert. In the case of gas appliances the engineer must be Gas Safe registered.

ACTIVATING THE ALARM

See diagram below

Your detector comes complete with an integrated power pack that will provide power for its entire operational life. To activate the power pack you need to pull the disabling tab (see image). This will in turn pull out the metal disabling clip, which is attached to the end of the tab, from the disabling socket which is situated on the underside of the detector. Retain the disabling tab for future use by taping it to page 20 of the CO-9X user manual.

NORMAL OPERATION OF THE ALARM

When the detector is activated the Power LED will begin to flash green once every minute to indicate that the detector is receiving power from the power pack and is fully operational.

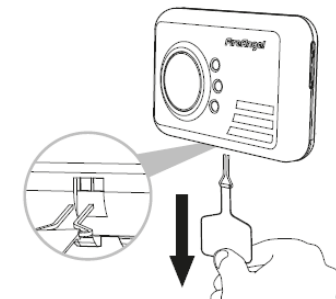

TESTING THE ALARM

Test the sounder, power pack and circuitry by pressing and holding the centre of the Test/Reset button briefly to confirm that the detector is operating properly. The sounder will sound as soon as the button is pressed, and the Alarm LED will illuminate red indicating that the sounder is working and the power pack is providing power to the unit. This test for the sounder, power pack and circuitry should be performed on a weekly basis. This should be continued for the lifetime of the product.

WARNING: Prolonged exposure to the sounder in close proximity to your ears may damage your hearing. Under normal operating conditions, the power pack will last for the lifetime of the product i.e 7 years. The detector will not protect against the risk of carbon monoxide poisoning when the power pack has drained

SENSOR TESTING.

The alarm manufacturer recommends that this is carried out monthly. See the CO-9X user manual for more details.

CO ALARM OPERATION WHEN CO DETECTED

The higher the concentration of carbon monoxide detected by the detector, the quicker it will respond. When sufficient carbon monoxide is detected a loud audible signal (85 dB at 1m (3 feet)) will be emitted and the Alarm LED will flash red once every second.

The Alarm will sound:

- Between 60 and 90 minutes when exposed to a minimum of 50ppm of CO.
- Between 10 and 40 minutes when exposed to a minimum of 100ppm of CO.
- Within 3 minutes when exposed to a minimum of 300ppm of CO.

FAULT / LOW POWER PACK SIGNAL:

The unit continuously checks the settings of its sensor and circuitry. If any of these settings are found to be incorrect or if the

power pack becomes low then the detector will emit a single chirp once per minute and the Fault LED will flash yellow once per minute for up to 30 days.

IMPORTANT: This does NOT mean that the detector has detected carbon monoxide.

MAINTENANCE

Your detector will alert you to potentially hazardous CO concentrations in your caravan when maintained properly. To maintain your FireAngel detector in proper working order, and to ensure that the sensor will last for the lifetime of the product, it is recommended that you:

- Test the sounder, power pack and circuitry of your detector at least once per week by pressing the Test/Reset button briefly (see above).
- Perform the Sensor Test once every month (See of the CO-9X user manual for more details).
- Keep the detector free of dust by gently vacuuming the case with a soft brush attachment once per month.

To prevent the possibility of contaminating the sensor in your detector and thus affecting its reliability:

- Never use cleaning solutions on your detector. Simply wipe with a slightly damp cloth.
- Do not paint the detector.
- Do not spray aerosols on or near the detector.
- Do not use any solvent based products near the detector.

Security chips

A special security chip is concealed within the body of every caravan. This chip contains the individual identity of your caravan and can only be read by using a special decoder by police officers.

Ventilation

All caravans comply with BS EN 721. The ventilation points on your caravan are fixed points of ventilation which are required by the European Standards.

All caravans have ventilation at high level and low level which have been calculated to suit the individual needs of your caravan.

High level ventilation is achieved by means of the roof lights and washroom roof ventilators. The low level ventilators are positioned underneath the oven housing. Some models with sliding doors have two vents located underneath the sliding doors.

Under no circumstances must these vents be blocked or obstructed.

It is advised that fixed ventilation points are checked and cleaned (if necessary) on a regular basis using a small brush and a domestic vacuum cleaner.

Additional night time ventilation is obtained by releasing the window catches and placing them in the second groove. Note the windows are not sealed from rain in this position.

As the ventilation levels are calculated to suit each models requirements there should be no modifications made which may result in reduced ventilation levels.

WARNING: Do not obstruct ventilation.

Petrol/Diesel Fumes

The fitting of a tail pipe extension to your car exhaust will reduce the possibility of fumes entering your caravan through the ventilation points.

Note: Never allow modification of electrical or LPG systems and appliances except by qualified persons at an authorised Swift Group dealership.

SECURITY**Caravan theft**

The theft of a caravan can occur in the most unlikely circumstances; from a motorway service area, even from an owner's driveway.

Secure all windows and doors when your caravan is unoccupied even if only for a short length of time.

Chassis number

Your 17 digit serial number chassis number can be found on your windows and on the offside chassis member of the drawbar. It is also stated on the manufacturers weight plate next to the doorway.

Make a note of this number in the space provided at the front of this handbook and make a separate note of the number to keep safe at home.

Additional security

Consider fitting any device which might deter or prevent intrusion by thieves.

A hitch lock cover prevents towing of the caravan.

A wheel lock prevents towing of the caravan and removal of the wheel (some models are provided with an AL-KO Secure device).

Customers are advised to identify their caravan with a method for subsequent identification if other forms of identification have been altered or removed.

Free crime prevention advice about securing your caravan, protecting your valuables, property marking, either at home or whilst on site, can be obtained from the Crime Prevention Officer through your local Police Station.

AL-KO SECURE IMMOBILISER

Caravan insurance

It is recommended that the caravan and its contents should be insured against theft.

It is essential to check with your car insurance company to ensure you are covered when towing your caravan.

AL-KO SECURE IMMOBILISER

The AL-KO immobiliser is fitted as standard on some models, optional on others. When fitted the 4 part kit specified below is supplied with your caravan. Your kit will contain : -

Part A

Box containing security components, consisting of:

- 1off High security locking bolt.
- 1off High security locking bar socket key.
- 1off Barrel lock.
- 2off Barrel lock keys.
- Instruction manuals in CD and paper format.
- Security registration card and reference number.

Part B

Wheel specific insert assembly consisting of:

- Red coloured wheel insert lozenge assembled with the locking bar and clip.

Part C

- 1off Wheel spanner.

Part D

- Kit bag.

YOU MUST REGISTER YOUR KEY WITHIN ONE MONTH OF THE DATE OF PURCHASE. SHOULD YOU FAIL TO DO THIS, YOU WILL NOT BE ABLE TO ORDER A SPARE KEY!

- Within your AL-KO kit will find an exclusive security number.
- Please register your card by telephoning 0870 7576788 or 0044 1926 818500.
- You will need to provide a password and provide an answer to a prompting security question.
- Make a note of your password and keep it in a safe place.
- Keep your registration card safe.
- Take your registration card with you when you are travelling with the caravan.
- Always keep your registration separate from the lock.

SAFETY INFORMATION (AL-KO Secure)

- Always secure the caravan against rolling away (chock or couple to a towing vehicle).
- Always remove AL-KO Secure before moving the caravan.
- After any attempt of theft has been made on a locked AL-KO Secure, the caravan must be inspected at an AL-KO Approved Service Workshop.
- Always keep the key in a safe place.
- Keep the lock set and registration card separate from the key.
- The lock parts and key do not have a registration number, therefore keep the registration card in a safe place.
- Caravans with twin axles have two locks, keep each lock set in a separate place.

The sets are not interchangeable!

AL-KO SIDE LIFT JACK

AL-KO OPERATING INSTRUCTIONS

- READ THE AL-KO OPERATING INSTRUCTIONS AND ACT IN ACCORDANCE WITH THEM.
- INSTRUCTIONS FOR GENERAL USE.
- FOLLOW ALL SAFETY INSTRUCTIONS AS WELL AS THE WARNING INFORMATION.
- IT IS RECOMMENDED FOR EASE OF FIT THAT A SIDE-LIFT JACK BE USED.
- KEEP THE OPERATING INSTRUCTIONS

THE AL-KO SIDE LIFT JACK

(SUPPLIED AS STANDARD ON SPECIFIC MODELS ONLY).

The AL-KO Side Lift Jack has been specifically developed to aid the often difficult process of changing a wheel on caravans. It is suitable for fitment to the AL-KO chassis, located in the pre-drilled holes in the longitudinal members.

Note: The fitment of some aftermarket motor movers may inhibit the use of the AL-KO jacking system.

SAFETY AND SECURITY

Water System	44
Tank types	45
Pressure switches	48
Plumbing troubleshooting	49
Fresh level sensor & cleaning	50
Pressure switch adjustment	50
Ultraflow Water Intake Housing	51
Water Fault Finding	53
Typical gas schematic drawing	55
Gas	56
Types of gas	57
Gas safety advice	58
Ventilation	59
Gas Fault Finding	60
Electrical system	61
Overseas connection	61
Wiring of connecting cable and caravan mains inlet	62
230V mains electrical equipment power consumption	63
Typical appliance consumption figures	64

WATER SYSTEM-INTRODUCTION

All Swift Group caravans water systems have been designed around a pump fitted within the caravan. This pump draws water from an external source, to provide water pressure within the caravan, whenever it is switched on and water is available.

The schematic below shows the basic configuration of the water system with inboard pump and no internal water tank:

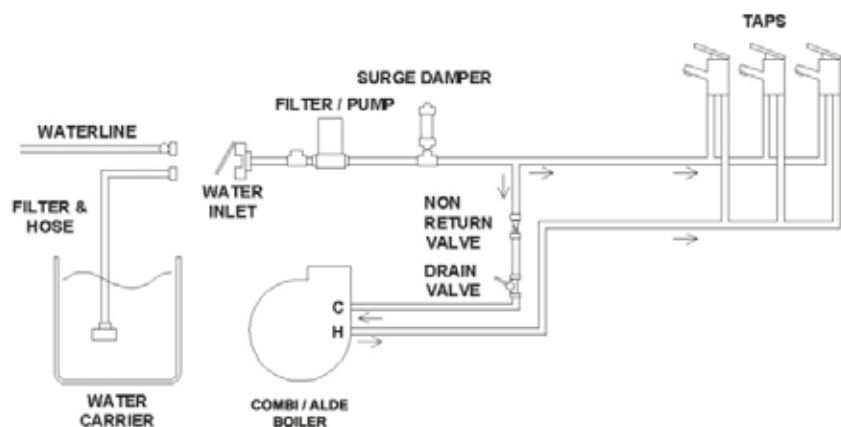

When power is supplied to the pump, it will draw water from the external container through the water inlet mounted on the side of the caravan, and pump it to the caravan taps, shower and water heater.

The pump is fitted with its own pressure switch, and the pump will continue to pump water, until the pressure of water on the output of the pump reaches a pre-set level. For this pressure to be achieved, the taps must be closed.

When the taps are opened, water will leave the tap via the spout, and the pressure in the pipes between the pump and the taps will reduce. Because of this reduction in pressure, the pressure switch on the pump will switch back on and the pump will again run to pump more water.

Close to the pump, the water under pressure is split into two paths:

1. Through blue water pipes routed directly to the cold connection of each tap.
2. To the water heater.

Water from the pump enters the bottom of the water heater. Once the water fills the water heater (typically 10 litres), water then leaves the water heater via a connection at the top of that water heater. This water, which is still under pressure, then routes to the hot connection of each tap via red pipes.

TANK TYPES – OVERVIEW

No Internal Water Tank

A caravan water system with no internal water tank functions in the following way:

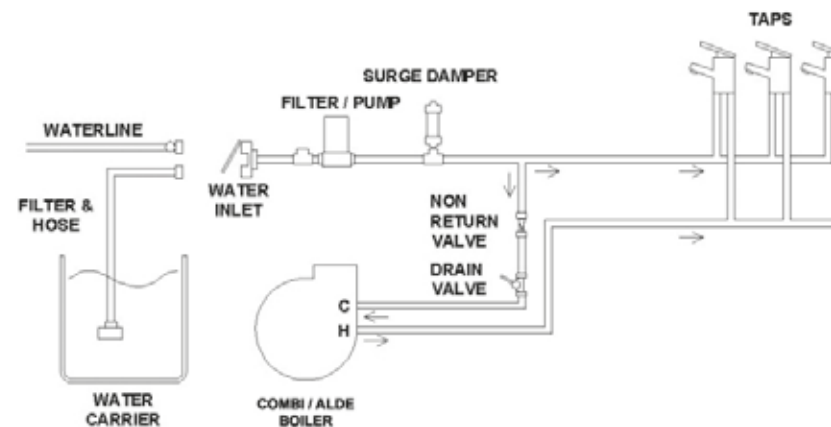

The inboard pump draws water into the caravan, via the inlet on the offside of the caravan. This is directed to the water heater, taps and shower. An umbilical hose, with baffle, is supplied with the caravan to connect between the inlet and an aquaroll or similar external container.

On Arrival at the campsite / Priming the system

- Ensure that the external water container is full.
- Close all of the taps (kitchen sink, bathroom, shower) except one, which should be open in the hot position.
- Ensure that the water heater drain valve is closed (move the Yellow handle on the floor near the water heater to a horizontal position).
- Switch the pump on using the button on the control panel. Water will flow through the open tap after a short time. This tap can then be moved to the cold position and again after a short time water will flow.

- Repeat the procedure at each tap.
- When using a mains water connection the pump will still need to be switched on to supply water to the water heater, taps and shower.
- If a mains water connection is used, please ensure this is a Truma Waterline connection, which has a built in pressure reducing valve.
- To drain / winterise the system please see separate details later in this handbook.

WATER TANKS

Internal Water tank (UK Caravans)

The following arrangement is used for a caravan with internal water tank:

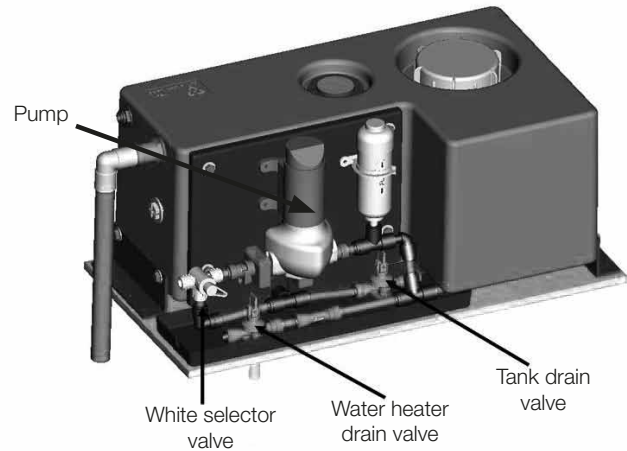
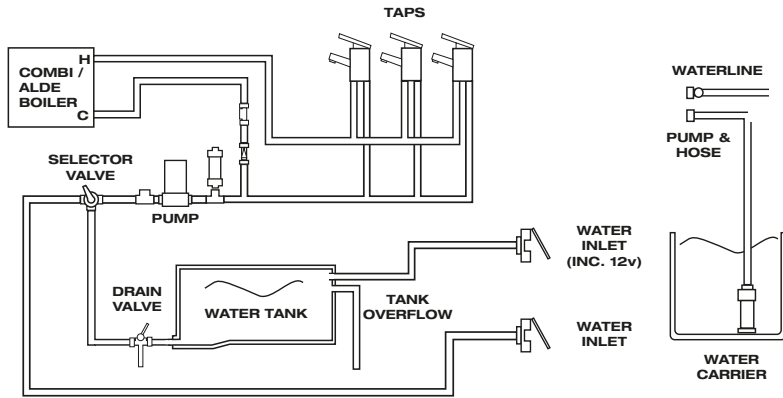

- Two water inlets are fitted on the outside of the caravan, on the offside. The upper inlet is used to fill the internal water tank, and the lower inlet is used to bypass the tank
- The inboard pump draws water from whichever water source is in use.
- A White selector valve located close to the pump is used to select the water supply from the external source or the internal tank (see valve positions on the next page).
- An external pump is supplied with the caravan, this can be used with the lower inlet when the onboard pump is being used to draw water from an external source.

- The same external pump can be used with the upper inlet, this will transfer water from the external source to the internal tank.
- When filling the internal tank, monitor the amount of water in the tank and stop filling before the tank overflows via the switch on the control panel.
- Please see label on bed flap rear for valve operation.
- The control panel above the door has buttons to turn on and off both the internal and external pumps.

INTERNAL TANK SUPPLY	EXTERNAL SUPPLY	DRAIN SYSTEM	WINTERISATION / STORAGE
			<ol style="list-style-type: none"> 1) With external pump connected to upper external socket, lift the external pump out of the water container and allow the pump to run briefly. 2) Disconnect the external pump and set the valves to drain the internal tank and water heater, as shown opposite. 3) Open the kitchen tap, vanity tap, shower mixer and shower head to the fully open, mixed hot and cold position, and allow system to drain. Run the internal pump briefly. 4) Dis-connect input and output connections to the internal pump and allow water to drain from connections (including filter body). Remove filter until further use. 5) Again run the internal pump for short time to expel any water from the pump body. 6) Unscrew shower head, or shower head and hose, and shake dry. 7) It is advised to leave the pump, and shower head and hose, disconnected until further use. <p>Please also check handbook and/or appliance manufacturers instructions for further winterisation advice</p>

When using EXTERNAL SUPPLY ensure external pump is connected to lower outer socket. Upper socket is used only to fill internal tank

On Arrival at the campsite / Priming the system

The caravan water system can be used with or without the internal water tank.

To use the caravan without the internal water tank:

- Ensure that the external water container is full.
- Connect the external pump to the lower connection point on the outside of the

caravan, labelled 'direct to taps'.

- Move the White selector valve close to the pump anti-clockwise to select the external source.
- Close all of the taps except one, and follow the steps as detailed for a caravan without internal water tank.

To use the caravan with the internal water tank:

- First prime the system as described for using the caravan without water tank.
- Ensure that the external water container is full.
- Connect the external pump to the upper connection point on the outside of the caravan, labelled 'direct to tank'.
- Ensure that the tank drain valve (which is a Yellow handled valve identical in appearance to the water heater drain valve) is in the closed position - with the handle horizontal.
- Rotate the handle of the White selector valve clockwise to select internal tank as the water source.
- Press the 'tank fill' button to transfer water from the external container to the internal tank.
- Water will now be transferred from the external container to the internal water tank. The amount of water within the internal tank can be checked by looking at the water level gauge on the control panel.
- Once the control panel shows this level at ¼ or higher, taps can be used as normal.
- Press the 'water pump' button to switch on the internal pump.
- When the control panel display shows the internal tank as full, or the external container is empty.
- Press the 'Tank Fill' button to switch off the external pump. Refill the external container if required.

To use the caravan with a mains water connection:

- When using a mains water connection the pump will still need to be switched on to supply water to the water heater, taps and shower.
- If a mains water connection is used, please ensure this is a Truma Waterline connection, which has a built in pressure reducing valve.

- The Waterline connection should be connected to the lower connection point on the outside of the caravan, labelled as 'direct to taps'.

PRESSURE SWITCHES

The purpose of a pressure switch is to monitor the pressure on the outlet side of the pump. When a tap is closed, and the pump continues to run, there is an increase of pressure in the system, and when that pressure reaches a pre-set limit, the pressure switch will turn the pump off.

The switch, mounted to the underneath of the pump, is part of the pump assembly, and cannot be replaced. However, in most cases, speed fittings are used, which allow easy and quick connection of water pipes

To connect a pipe to a fitting, simply push the pipe into the connector. To remove the pipe, push the collar of the fitting inwards, and then withdraw the pipe.



To connect a pipe, simply push the pipe into the connector.

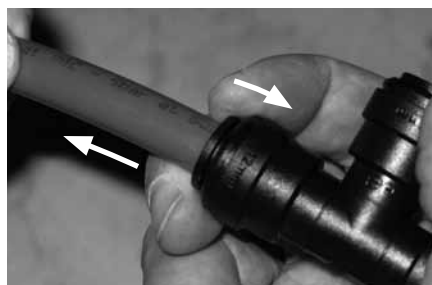

To remove a pipe, push the collar inwards, and then remove the pipe.

As a note, when refitting the pipe, ensure the end of the pipe is round (not oval) and the cut is square. If not, it could lead to water leaks.

TROUBLESHOOTING**Pump will not start, when the tap is opened:**

- Check fuse(s).
- Check power source(s), and ensure there is sufficient voltage to run the pump.
- Ensure 'pump' LED is illuminated.
- Using a multi-meter, ensure there is power at the pump. If not, refer to your dealer as there may be damaged cabling or a fault with the fusebox.
- Is the pump hot? If so, allow to cool before retrying.
- Has the vehicle been stored over winter? Was it correctly winterised? If no, the pump may have frozen, causing permanent damage.
- The pressure switch may need adjusting. See page 50 on how to do this.

Pump runs, but will not pressurise system (i.e. no or little water being discharged from taps) - Not Pulsing:

- Ensure water in source is present (onboard tank or aqua roll).
- Check in-line pump filter is free from debris and correctly fitted.
- Ensure water system has been primed correctly, as per the handbook, and there are no air-locks present.
- Ensure there are no restrictions in the plumbing.
- Using a multi-meter, ensure there is power at the pump. If not, refer to your dealer as there may be damaged cabling or a fault with the fusebox.
- Ensure the inlet side of the pump

(including Truma inlet and in-line filter) are watertight and not allowing air into the system.

- Ensure the pump has good voltage.
- Check (using a multimeter) that the voltage at the pump is between 10v-14.5v.

Pump continues to run (for more than 5 seconds) after taps are closed or pump turns on for no reason:

- Check for leaks on the high pressure side of the pump.
- Ensure water system has been primed correctly, as per the handbook, and there are no air-locks present.
- Ensure the pump is securely mounted.
- Ensure the piping on the high pressure side of the pump is in good condition (not blowing or deforming).
- The pressure switch may need adjusting. See page 50 for information on how to do this.

Noisy or rough operation

- Check for leaks on the high pressure and low pressure side of the pump.
- Ensure that all pipes (especially those within 150mm of the pump) are not touching any furniture.
- Ensure the pump is securely mounted.

Pump rapidly cycles (switches on or off) or water pulses from taps, including temperature pulsing:

- Check for leaks on the high pressure and low pressure side of the pump.
- Ensure there are no restrictions in the plumbing
- The pressure switch may need adjusting. See Section (page 50) for information on how to do this.

FRESH LEVEL SENSOR & CLEANING

Principle

The sensor, fitted to Swift Group caravans are pre-fitted to water tanks, and link to the fusebox, via a pre-fitted wiring harness. The sensors, which consist of a number of stainless steel rods or probes, at different lengths, are immersed in the fresh water, and use the conductivity of water, between the probes, to provide a reading to the fusebox.

The sensors are 'digital', in that while the conductivity (resistance) value can vary, the fusebox will register any conductivity between the reference probe and the various different length probes, indicating water present.

Normally, even if the rods are dirty, and providing the rods have not bridged by a foreign object, a circuit will still be delivered back to the fusebox and a water level displayed.

Sensor cleaning

The first step, in case of fault diagnosis, is to clean the sensor rods. False water level reading at the control panel can be caused by calcium build up or foreign objects within the tank bridging the probes.

SENSOR CLEANING INSTRUCTIONS

Cleaning recommendations for lime scale build up:

- (1) Remove sensor from tank.
- (2) Check probes for build up or contamination.
- (3) Use clean soapy water.
- (4) Place scourer in water and dampen.
- (5) Apply scourer to sensor probe with limited pressure.
- (6) Rub sensor probe removing contamination.
- (7) Swill sensor with fresh clean water.

- (8) Replace probe into tank.

Suggested scourers - food safe

Plastic mesh scourer

- (1) Material: It is made of plastic.
- (2) Usage: Used for cleaning steel utensils, dishes, pots, pans, ovens, Bar-B-Que grills, glass, cutlery, sinks, kitchen and bathroom tiles and tubs etc.

PRESSURE SWITCH ADJUSTMENT

Pressure Switch Adjustment, Truma/Flo-Jet pump. (Normally Grey upper section with White lower section/valve housing)

- All of the Truma/Flo-Jet pumps used by Swift are pre-set at 28psi + / -3psi.
- To further adjust the pressure switch setting, a cover cap must be first be removed from the end of the pump to reveal a pressure adjusting screw, as shown in the photos. A maximum of 1/4 turn clockwise or anti-clockwise, from the factory setting, is advised. Turning the screw clockwise 1/4 turn will increase the pressure switch cut-out pressure, turning the screw anti-clockwise will reduce the pressure setting.
- Please note a second screw mounted below the cover cap is set in position with threadlock, this should not be disturbed.

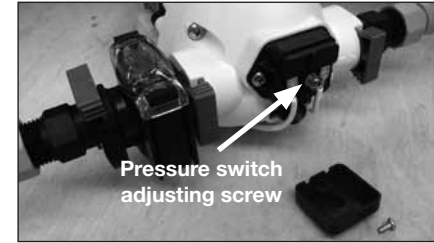

ULTRAFLOW WATER INTAKE HOUSING

Operating instructions

Raise the lid, clean both the water socket and the plug of the Intake Assembly.

Plug the intake connector into the socket.

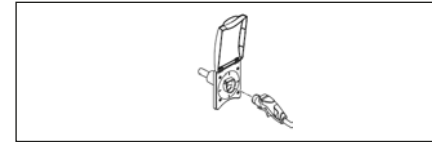

Place the assembly into the water container, ensuring that it is fully submerged before operating the system. The Dust cover is to stop contaminants falling into the water container.

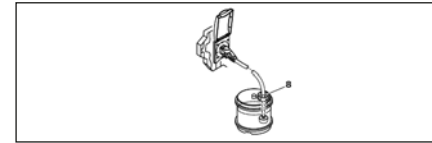

To remove the Intake Assembly from the Water Intake Housing. To remove, pull the lower trigger and pull out the hose plug.

WARNING: Do not remove by pulling the hose. Please ensure that the lid is properly closed before driving!

Routine maintenance

Ensure that the O-ring seal on the hose plug and the socket are free from dirt. To aid fitting of the plug assembly smear the O-ring with vegetable oil.

Notes

Before winter storage the water system must be completely drained and the filter cartridge (only with the Ultraflow Filter Housing) removed. The filter hole may be sealed with the filter cap.

Clean the water system at the start and end of the season with sterilising fluid (see notes under sterilising).

If the pump fails to deliver water the most likely cause will be air in the system. Switch off the pump and shake the pump assembly in the water. Then switch on again.

Sterilising

When cleaning the water system at the start or the end of the season it is advisable to use a sterilising fluid e.g. Chempro SDP or similar.

Flush the system thoroughly to remove the effective fluid traces.

After sterilising the system at the start of the season it is recommended that in the Ultraflow Filter Housing a new filter cartridge should be fitted.

When water is first introduced, or the water supply in the internal tank, or aquaroll, runs out, air will be present in the pipework. It is important that every tap is run to remove any air in the system before, for instance, the shower is used. Air left in pipework local to a tap can act as an accumulator and affect the ratio of hot and cold water flowing from other taps or shower mixers in the system.

System care

Allowing water to freeze in the system may result in damage to the pump and plumbing system.

Non-Toxic antifreeze for potable water may be used with Truma pumps. Follow manufacturers recommendations.

Do not use automotive antifreeze to winterize potable water systems. These solutions are highly toxic and may cause serious injury or death if ingested.

Sanitising

Guidance on cleaning portable water tanks and the water system in touring caravans.

The water systems, and in particular storage tanks, in caravans are susceptible to contamination by bacteria if care is not taken with their use and cleaning. The symptoms caused by bacterial contamination are not purely limited to gastro-intestinal diseases, but may also manifest themselves as ear, nose, throat, eye or skin infections. It is therefore important that you carry out the following procedure prior to using the caravan each time, even if you boil or filter all water you use for drinking.

Separate Water Containers

1. All water remaining in the container should be disposed of so that the container is empty.
2. The outside of the container should be thoroughly cleansed and washed down to remove any dirt, dust or other contaminant. Water at a suitably hot temperature containing an appropriate detergent is recommended for this purpose.
3. Water should be put in the container, swirled around, then emptied out.
4. The container should then be totally filled with water containing an appropriate sterilant solution and allowed to stand for the recommended contact time (e.g. Milton for 15 minutes).
5. The solution should be emptied from the container.
6. The opening of the container should be cleaned thoroughly with an appropriate prepared wipe impregnated with a sterilant.
7. The container should be inverted whilst stored overnight (if possible).
8. The container must be filled with mains water only and mains water only should be used for the above cleaning procedure.
9. On no account should garden hoses be used to fill water tanks.

For Systems:

1. Drain down the system (open all taps to allow air in, enabling the system to drain quickly).
2. Remove any water filters fitted, and replace with a short length of hose or empty filter cartridge (this will ensure the filter is not affected by the disinfectant/sterilant solution).
3. Fill the system by using the pump with a disinfectant/sterilant solution (check that the solution at full strength appears at all taps/showers). Allow to stand for the recommended period of time.
4. Drain the system completely.
5. Thoroughly clean the outside of all taps/connectors with a cloth soaked in the disinfectant/sterilant.
6. Flush the system through with clean drinking water until no traces of disinfectant/sterilant can be detected at any tap.
7. Replace the filter.

Suitable sterilising chemicals are available from your caravan dealer, accessory shop, chemist or home-brew shops. It is not, however, recommended to use bleach or sodium metabisulphite.

WATER

Fault	Cause	Remedy
Water not flowing from any tap when operated but pump runs	Freshwater tank empty Pump wired in reverse Pipe inlet or outlet pipe disconnected Pump pipes restricted by kinking Blockage in pump inlet or outlet pipe Blocked in-line filter of pump filter Air leak in suction line to pump	Check Check wiring, refer to pump manufacturers instructions Check connections Check pipes run Check, starting inside freshwater tank Dismantle and clean Check for bubbles.
Pump does not run	Pump or tap incorrectly wired Pump fuse blown Battery disconnected Pump seized or overheated Pressure pump sensing switch may have failed Contacts may be faulty Wiring connections may be faulty	Refer to pump/tap manufacturers instructions Check wiring connection and then replace with fuse of correct rating Check connections Refer to pump manufacturers servicing instructions Refer to pump manufacturers servicing instructions Check contacts in plug and socket are clean and making contact Check wiring connections
Water flows from cold tap but not from hot	Feed pipe to water heater incorrectly connected to the heater outlet Blockage in hot pipeline Heater inlet or outlet pipes kinked preventing flow Hot tap not connected Hot tap failed or blocked Heater non-return valve jammed	Refer to installation instructions Disconnect pipes and inspect. Check and re-route if necessary. Check pipe and connect where required. Disconnect and inspect. Refer to dealer.

WATER FAULTS

WATER

Fault	Cause	Remedy
Water flows from hot tap but has reduced flow from cold	Cold water pipe kinked preventing flow	Check and re-route if necessary
	Blockage in cold pipe line	Disconnect pipes after 1st connector and check up to tap
	Cold tap not connected	Refer to installation instructions
	Cold tap failed or blocked	Disconnect and inspect
Reduced flow from both hot and cold taps	Battery condition low causing pump to run slowly	Check battery state of charge, refer to electrical supply note
	If new taps have been fitted they may be restricting flow	Disconnect and check that they have at least 1/4" (6.3mm) bore
	Pump needs servicing	Refer to pump servicing instructions
	Partially blocked pump filter or in-line filter, if fitted	Dismantle and clean if necessary
	Pump outlet pipe kinked restricting flow	Check and re-route if necessary
	Water leak	Check all water connections
Reduced flow from either tap	Pipe kinking restricting flow	Check and re-route if necessary
If pump motor runs steadily and will not stop	Battery voltage may be too low (below 10.5 volts)	Check that there is water in the container Adjust switch and/or re-charge battery
	Pressure Switch setting problem	Check all connections in pipework. Adjust settings.

GAS SCHEMATIC

Typical gas schematic drawing

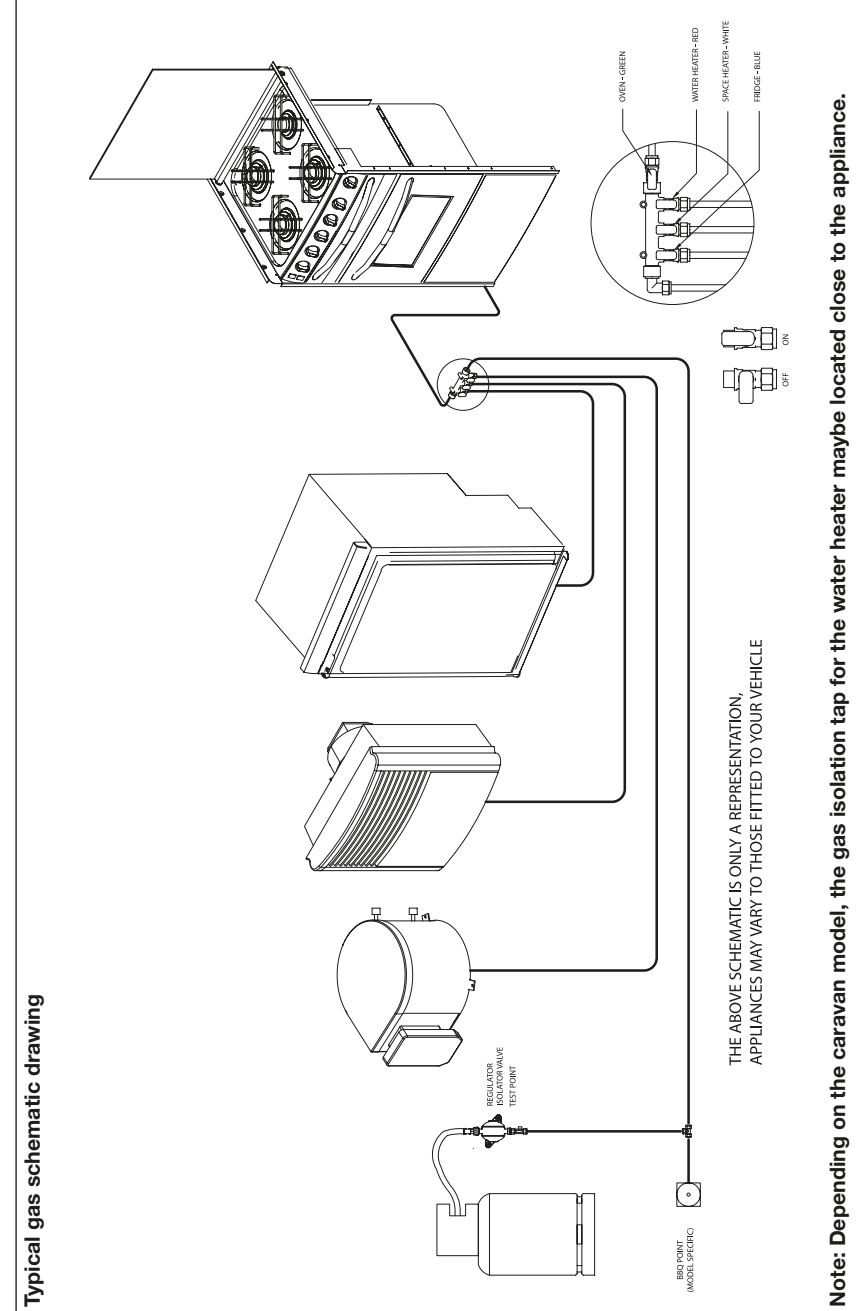

Note: Depending on the caravan model, the gas isolation tap for the water heater maybe located close to the appliance.

GAS

GENERAL INFORMATION

Gas Bottles

Bottled Liquefied Petroleum Gas (LPG) is the most convenient portable source of fuel for your caravan. Make sure that heating and cooking appliances and the gas cylinders are switched off before you move the caravan.

Regularly check flexible gas hose, joints and connections for tightness.

Finally make sure that each gas appliance is working efficiently to the recommendations of the appliance manufacturers.

Only use gas bottle cylinders that are located within their dedicated position within the front gas bottle housing, never extend hose - hose lengths must not exceed 400mm.

Regulator

Your caravan is supplied with a wall mounted gas regulator plumbed inside the gas bottle compartment. The regulator and all appliances work at a harmonised 30mbar pressure, which work with Butane and Propane gas.

Your caravan is supplied with a stainless steel propane hose to connect to a propane gas bottle.

Pressure regulation system in this vehicle has a fixed working pressure of 30 mbar with a flow rate of 1.5 kg/h and complies with the requirements of EN 12864 annex D.

Note: Regulator valves and bottle valves should always be in the 'OFF' position when towing and storage.

WARNING: When leaving the caravan for any period of time or storage always turn off the gas at the gas cylinder.

DuoControl (Model Specific)



The DuoControl combines the gas pressure regulator and the changeover valve in one unit for operation as a two-cylinder system. When the operating cylinder is empty, DuoControl automatically changes over to the reserve cylinder.

- Combines a gas pressure regulator and a changeover valve in one unit
- Automatically switches over to the reserve cylinder
- Complies with EN 13786

Gas Hoses

A high pressure hose must be used with the new style regulator (Fig B) to connect to the gas bottle.



Fig B Gas regulator

LPG bottles i.e. Propane, Butane and Camping Gaz cylinders all have varying bottle adaptor connections. The Swift Group provides a stainless steel propane hose for use with propane gas bottles. It is important to check you have the correct hose and adaptor to suit your gas bottles. Push on hoses are no longer permitted under the new regulations, The new high-pressure hoses have threaded connections and must be securely attached to the regulator and to the gas bottle.

Ensure that there is a constant rise in the flexible gas hose between the gas bottle outlet and the regulator elbow.

WARNING: Inspect flexible gas hose(s) regularly for deterioration and renew as necessary with the approved type, in any case no later than 5 years after the date of manufacture marked on the hose.

WARNING: Ensure hoses do not become entangled in door mechanism.

Cylinder compartment

All cylinder compartments have two universal plastic mouldings fitted to the floor of the compartment that are designed to fit both steel and BP Gas Light cylinders and two universal support cradles with straps for retaining the bodies of the cylinders at mid to high level and two universal support cradles with straps for retaining the bodies of the cylinders at mid to high level.

TYPES OF GAS

Propane

Propane is supplied in red, or partly red bottles which have a female left hand threaded connector.

Scandinavian countries use the same connector.

Germany and Austria supply propane with a male connection.

Propane will work at temperatures as low as -40°C and is therefore suitable for all winter caravanning.

Butane

Butane is supplied in the U.K. in green or blue bottles.

All these have a male left hand thread

EXCEPT for Camping Gaz which has a special female right hand thread and Calor 7kg and 15kg and aluminium bottles which have a special clip-on connection.

Continental bottles usually have a male left hand thread similar to but not identical with U.K. butane.

Butane is only suitable for use at temperatures down to 2°C and will not work below that.

GAS SAFETY ADVICE

WARNING: If you smell gas or suspect a leak or in the event of a fire and if it is safe to do so, isolate the gas appliances and turn off the gas bottles at the regulator. Evacuate the caravan and ventilate. Seek professional advice as to the cause of the leak.

WARNING: Inside outlet sockets shall only be used with dedicated appliances i.e. equipment supplied with the Touring Caravan. No gas appliances shall be used outside when connected to an inside socket

Facts about LPG

- LPG is not poisonous.
- Bi-products are harmless.
- There is danger if all air and oxygen were excluded.
- (Ventilation holes must be kept clear at all times).
- LPG has been given a smell by the manufacturers in order to identify leaks.

Awning Spaces LPG Appliance Exhaust

There is no danger of pollution of an enclosed awning space by the LPG exhaust from a refrigerator venting into it, as awning spaces are generally well ventilated.

Space heaters may produce sufficient exhaust to pollute the awning space, if it is totally enclosed, from a general comfort, smell and hygiene point of view. In the extreme case there could be a build up of carbon dioxide to a dangerous level.

Caravan owners are advised to allow some fresh air circulation in the awning space when such appliances are in use.

Precautions

- Never look for a leak with a match. Always use a soap solution or its equivalent when testing connections. Do not operate any electrical apparatus whatsoever, especially light switches. If the leak is not obvious, the caravan should be evacuated and qualified personnel consulted.
- Avoid naked lights when connecting or changing a cylinder.
- Check the flexible hose frequently.
- The gas is heavier than air and therefore sinks to the lowest point.
- Keep bottle gas containers outside (and protected against frost). If they must be kept inside make sure they are well away from heat.

WARNING: Do not use appliances with a different working pressure to 30mbar.

WARNING: Maintain adequate spacing of combustible materials from sources of heat.

WARNING: Do not use independent portable gas appliances inside the vehicle. Cookers shall not be used as heaters

WARNING: A BBQ point inlet valve, if fitted, must only be used for the connection of portable LPG appliances.

Always read individual appliance instructions

Connection

Ensure that the gas regulator hose is correctly connected to the gas cylinder in gas bottle compartment and that the hose connection is tight.

Gas bottles must be fully located, seated at the base of the bottles and restrained by the strap provided in the dedicated compartment position.

Straps are positioned to suit 6kg and 7kg bottles.

WARNING: If using cylinders other than those recommended, the user must ensure these are adequately supported, ventilation openings must not be obstructed and the cylinders must not cause damage to other fixtures and fittings located in the compartment.

Open ended gas hoses must always be protected from dirt and insects.

Before turning on the gas supply at the regulator, ensure that all gas operated equipment in the caravan is turned off.

All gas equipment (except barbecue and some water heaters) is supplied through a central Gas Manifold System which has individual isolation taps for each appliance (Fig A), as follows:



RED	-	Water Heater
WHITE	-	Space Heater
BLUE	-	Fridge
GREEN	-	Oven

Note: the external barbecue point is fed from the main feed through a built in integrated isolation valve. See schematic layout for details (page 55).

NOTE: In some installations the water heater is fitted with a separate isolation valve.

Ventilation

All ventilation complies with BSEN 721 and vents should not be obstructed in any manner as this could lead to insufficient fresh air. In this case the confined atmosphere becomes depleted of oxygen which leads to the

formation of the highly poisonous gas 'carbon monoxide'. Carbon Monoxide is odourless, colourless and tasteless and will rapidly cause unconsciousness and death with little or no warning prior to collapse.

THERE IS NO DANGER WHEN ADEQUATE VENTILATION IS PROVIDED. KEEP SCREENS OR GRILLS CLEAN AND FREE FROM DUST

Roof-mounted Flue installations

All flue installations should be inspected once a year throughout their length for corrosion. Flues should be replaced if any sign of perforation is found. Ensure that the replacement is of an approved type.

Thermal insulation heating

Your caravan has been designed and manufactured to a grade 3 thermal insulation and heating level for specific climatic conditions and tested according to the procedure in EN1645-1.

The classifications are as follows:

Grade 1

A caravan with an average thermal transmittance (u) that does not exceed 1.7w/(m2k).

Grade 2

A caravan with an average thermal transmittance (u) that does not exceed 1.7w/(m2k) and which can achieve an average temperature difference of at least 20k between inside and outside temperatures when the outside temperature is 0°C.

Grade 3

A caravan with an average thermal transmittance (u) that does not exceed 1.2w/(m2k) and which can achieve an average temperature difference of at least 35k between inside and outside temperatures when the outside temperature is -15°C.

GAS FAULTS

GAS

Fault	Cause	Remedy
Hob does not light	No gas Air in pipe	Check level of gas in bottle Check gas bottle valve is on Check gas taps are on Purge system Refer to hob manufacturers instructions
Oven does not light	No gas Air in pipe	Check level of gas in bottle Check gas bottle valve is on Check gas taps are on Purge system Refer to oven manufacturers instructions
Space heater will not light.	No gas Over gassed Air in pipe	Check level of gas in bottle Check gas bottle valve is on Check gas taps are on Check exhaust outlet is clear Turn off appliance, wait 2 minutes and try again Purge system Refer to space heater or boiler manufacturers instructions
Fridge does not light	No gas Air in pipe	Check level of gas in bottle Check gas bottle valve is on Check gas taps are on Purge system Refer to fridge manufacturers instructions
Water heater does not light	No gas Air in pipe Fuse cover fitted.	Check level of gas in bottle Check gas bottle valve is on Check gas taps are on Purge system Refer to water heater manufacturers instructions. Remove cover and wait 2 minutes then re-attempt

ELECTRICAL SYSTEM

THE ELECTRICAL SYSTEM

General Information

It is strongly advised that the mains installation is inspected periodically to ensure safe use. The IET (BS7671) wiring regulations recommend that mains installations in touring caravans are re-inspected every 3 years. The National Caravan Council lists the qualifications necessary to perform this inspection, but an NICEIC approved contractor is probably the first choice.

On arrival at the campsite

- Disconnect hitch and 13 pin plug from the towing vehicle.
- Place the 13 pin plug in the holder provided to prevent damage.



13 pin plug example

- Check the suitability of the supply, is it AC or DC, is the voltage and frequency correct.
- Ensure that there is a proper earth (3 pin socket outlet).
- If in doubt consult site staff.
- Make sure that the supply from the site is switched off.
- Make sure that the charger switch on the PSU is switched off.
- Lift the cover on the electricity inlet on the caravan, and insert the connector on the flexible supply cable.
- At the site supply point, connect the other end of the supply cable to this using the socket provided.

- Switch on the main switch at the site supply point.

CARE POINT: It is good practice to test the RCD (Residual Current Device) in the PSU before switching on. There is a test button on the RCD to test the lever, put the lever in the up position (on) before testing.

CARE POINT: As with the RCD it is good practice to check the Miniture Circuit Breaker (MCB) in the PSU. Switch all to the on position (lever up). If any do not stay up then there is a fault.

On departure from the campsite

- Switch off supply from the site, disconnect the cable at both ends.
- Switch off RCD.

WARNING: current consumption in the caravan must not exceed 16 amps or the pitch permitted maximum if this is less than 16 amps.

OVERSEAS CONNECTION

- Connection to a mains voltage overseas requires particular attention.
- Overseas supplies can be of reverse polarity.
- Reverse polarity results in equipment not necessarily being isolated when turned off, reverse polarity indicator on the PSU will light in the event of reverse polarity.
- The only sure way to make equipment safe is to unplug it.
- It is useful to have a means of checking polarity when overseas.
- If it can be achieved then connect live to live, and neutral to neutral to achieve full electrical protection.

WARNING: Never allow modifications of electrical or LPG systems and appliances except by qualified persons.

TYPICAL APPLIANCE CONSUMPTION FIGURES

TYPICAL APPLIANCE CONSUMPTION FIGURES

Appliance/ Item	230 Volt		12 Volt		LP Gas grams/hour
	Watts	Amperes	Watts	Amperes	
Theftord Refrigerator	140 / 200 W	0.6 / 0.9 amp	Only when towing		13 g/h
Alde 3010 Heating System	1050 / 2100 W	4.6 / 9.1 amp	12W	1.0 amp	245 - 460 g/h
Truma Space Heater	500 W / 1000 W / 2000 W	2.2 / 4.3 / 8.5 amp	12 W	1.0 amp	30 to 280 g/h
Truma Ultrastore Water heater	850 W / 1300 W	3.7 / 5.6 amp	Not applicable		120 g/h
Microwave (factory fit)	1000 W	4.3 amp	Not applicable		Not applicable
Cooker hob burners	Not applicable		Not applicable		70 - 161 g/h
Cooker Electric Hotplate	850W	3.7 amp	Not applicable		Not applicable
Grill	Not applicable		Not applicable		117 g/h
Oven	Not applicable		Not applicable		125 g/h
Battery Charger	690 W	3.0 amp	Not applicable		Not applicable
12V Lighting (based on 10 W bulb)	Not applicable		10 W	0.8 amp	Not applicable
Pressure switched pump	Not applicable		48 W	4.0 amp	Not applicable

Note: These are approximate figures for guidance only.

EC400/EC450 Power Control System	66
Control Panel Operation	69
Residual Current Device & Miniature circuit breakers	70
Battery charger	71
Leisure Battery	71
12 Volt DC Fuses.....	73
Electrical faults.....	77
Technical Data & Approvals	80
Thetford battery box	82
Battery installation	83
Solar panel connection point	84
Generator usage	84
Habitation relay	85
Exterior 230v socket.....	85

EC400/EC450 POWER CONTROL SYSTEM

1. Introduction

This section of the handbook will guide you through the operation of the electrical system. Further technical details are contained in section 3 or in the supporting dealer technical manual available from www.sargentltd.co.uk

For the safe operation of all electrical equipment within your Leisure Vehicle it is important that you read and fully understand these instructions. If you are unsure of any point please contact your dealer / distributor for advice before use.

The system has a number of key components that you will need to be familiar with before attempting to use the system, these are:

- **The EC400 / EC450 series Power Supply Unit (PSU)** - a combined mains consumer unit and 12V controller located in the front locker or bed box area. On locker mounted caravan versions this unit also contains the provision for the Radio/CD head unit. The EC400 / EC450 series of power supply units include the EC400 range (horizontal units) and the EC450 range (vertical units), further details are contained later in this document.
- **The EC400 / EC450 series Control Panel (CP)** - a remotely located user control panel used to turn circuits on and off and to display battery and water tank information. This panel uses simple straightforward controls and reliable data communication to the PSU.
- **Road Light Fuse Box** - This small unit, which is unique to caravans, is located in the front bed box. The unit houses fuses for the road lighting circuits and supplies from the tow vehicle, and also has connectors for the optional alarm system and Automatic Trailer Control (ATC) unit.

2 Using the System

The PSU is located in the front offside locker area or front bed box in caravans.

2.1 Power Supply Unit - Models

A number of different PSU versions are used within the system. The operation of each model is very similar and is detailed below.



EC400 Sprite/Challenger Sport & Eccles Sport



EC450 Challenger/Conqueror/ Eccles & Elite

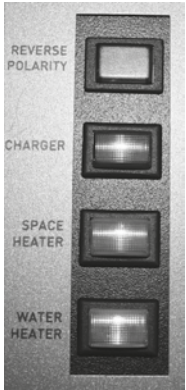
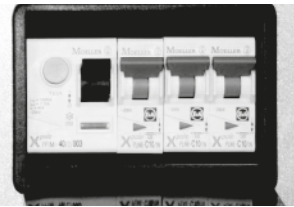

2.2 Power Supply Unit - Component Layout

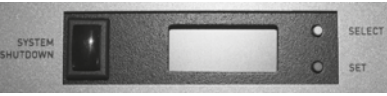
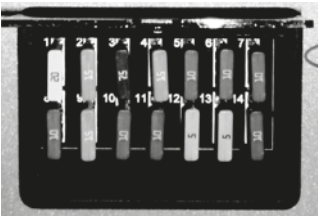
230V Components	
	<p>Red indicator – Reverse polarity indicator, lights up when the 230V supply polarity is reversed.</p> <p>Green push switch – Charger switch, this switch turns the 12V battery charger on or off. “In” is on “out” is off.</p> <p>Amber push switch – Space heater switch, this switch turns the 230V supply to the space heater / combination heater / central heating system on or off. In is on out is off.</p> <p>Clear push switch – Water heater switch, this switch turns the 230V supply to the separate water heater on or off. In is on out is off.</p> <p>Note, If the vehicle contains a combined space & water heater then this button is not used.</p>
	<p>Black lever switch, far left – Residual Current protection Device (RCD) and main 230V on / off switch.</p> <p>Yellow button, far left – RCD test button.</p>
	<p>Red lever switches, right – 3 x 10A Miniature Circuit Breakers (MCB). Please note that installations with a 3kW Alde heating system will have 2 x 10A and 1x16A MCB's.</p>
12V Components	
	<p>Black push switch, far left – System shutdown switch, this switch turns the power control system on or off. In is on out is off.</p> <p>Yellow push button, top right – Select button, this button is used to scroll through the display items on the LCD screen.</p> <p>Red push button, bottom right – Set button, this button is used to change the setting of the displayed item on the LCD screen.</p>
	<p>12V DC circuit protection fuses.</p> <p>Fuse number 1 is top left;</p> <p>Fuse number 14 is bottom, right.</p> <p>See section 3.5 for full fuse allocation details.</p>

2.3 Activating the System

The EC400 / EC450 system has a shutdown feature that should be used when the vehicle is in storage or is not being used for long periods of time. This allows the leisure electronics to be turned off when not required to save battery power. When in the off state the alarm and tracking system supplies are still active, most other supplies are turned off.

Before using the system please ensure the shutdown switch is in the system on position (button in).

2.4 Connecting to the Mains 230V supply and Safety checks

For your safety it is IMPORTANT that you follow these connection instructions each time your Leisure Vehicle is connected to a mains supply. This section assumes that the system is complete and that a Leisure battery has been installed (see 3.4).

A) Ensure suitability of the Mains Supply.

Your Leisure Vehicle should only be connected to an approved supply that meets the requirements of BS7671 or relevant harmonised standards. In most cases the site warden will hold information regarding suitability of supply. If using a generator you also need to comply with the requirements / instructions supplied with the generator.

Please note that some electronic generators may not be compatible with your leisure system. Further generator operational information is contained elsewhere in this manual.

B) Switch the PSU internal Power Converter OFF.

Locate the green 'Charger' power switch on the PSU and ensure the switch is in the off position (button out) before connection to the mains supply.

C) Connect the Hook-up Lead.

Firstly connect the supplied hook-up lead (orange cable with blue connectors) to the Leisure Vehicle and then connect to the mains supply.

D) Check Residual Current Device operation.

Locate the RCD within the PSU and ensure the RCD is switched on (lever in up position). Press the 'Test' button and confirm that the RCD turns off (lever in down position). Switch the RCD back to the on position (lever in up position). If the test button failed to operate the RCD see section 3.10.

E) Check Miniature Circuit Breakers.

Locate the MCB's within the PSU (adjacent to the RCD) and ensure they are all in the on (up) position. If any MCB's fail to 'latch' in the on position see section 3.10.

F) Turn the PSU ON.

Locate the black 'Shutdown' button and ensure it is in the on position (press button in). Locate the green 'Charger' switch on the PSU and turn to the on position (press button in). The charger switch will illuminate when turned on.

G) Check correct Polarity.

Locate the 'Reverse polarity' indicator on the PSU and ensure that the indicator is NOT illuminated. If the indicator is illuminated see section 3.10.

H) Check operation of equipment.

It is now safe to operate the 12v and 230v equipment.

2.5 Control Panel - Component Layout

Depending on your type of caravan the control panel will vary in specification.

Not all features are present in all vehicles. Please refer to the following diagrams to identify your control panel.

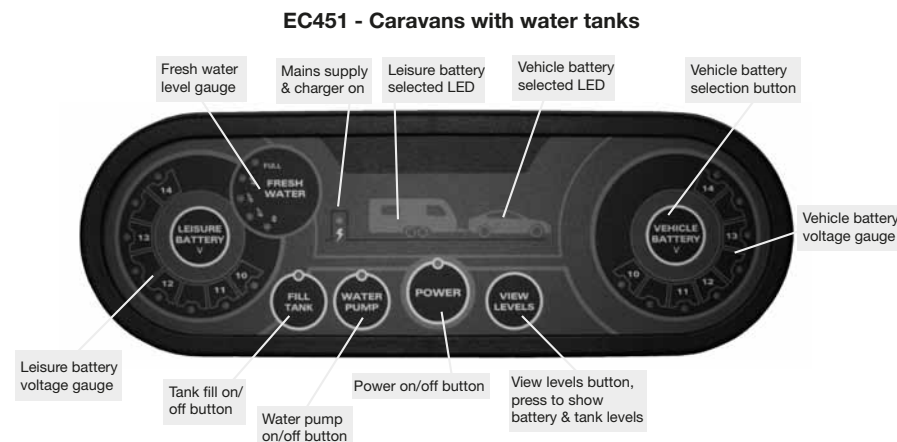

EC442 - Caravans without water tanks



2.6 Control Panel Operation

- **Power Button.** Press the power button to turn the leisure power on. Press the button again to turn the power off. The adjacent LED will illuminate when the power is on, and also the voltage of the selected battery will be displayed on the voltage gauge.
- **Pump Button.** With the power on, press the pump button to turn the water pump on. Press the button again to turn the pump off. The adjacent LED will illuminate when the pump is on, and also the level of the water tank will be displayed on the water gauge.
- **View Levels.** To display the battery voltage levels and the water tank levels on the control panel gauges, press the levels button. The display will remain illuminated for 10 seconds. It is possible to lock the

display 'on' to allow continuous display. This can be achieved by pressing and holding the view levels button for 2-3 seconds until you hear a beep. To turn this locked feature off, either press and hold the view levels button again for 2-3 seconds or turn the power off and back on.

- **Battery Select.** By default, the leisure battery is selected as the power source if no mains supply is present, or as the battery to be charged when the mains supply is available. To change the selected battery, press the vehicle battery select button. The selected battery is indicated by an LED adjacent to the caravan or car logo.
- **Mains on indication.** When connected to a 230v supply the LED with a "lightning strike" shown will be illuminated.

EC450/EC455 POWER CONTROL SYSTEM

- **Charging when the vehicle engine is running.** When the vehicle engine is running both the vehicle battery and the leisure battery LED's will flash in unison to indicate that they are connected together and are being charged by the vehicle.
- **Tank Fill Button.** For some caravans, with the power on, press the tank fill button to turn the external filler pump on or off. Please ensure you switch the fill button off when the external tank is empty to prevent damage to the pump.

2.7 Operation while driving

The EC400 / EC450 system is designed to shutdown parts of the system while the engine is running. This is to meet Electro Magnetic Compatibility (EMC) regulations and to ensure the safe operation of the caravan. This is indicated by the two battery LED's flashing together.

Please ensure the system shutdown switch on the PSU is in the "on" (button in) position before driving (see 2.3). This will ensure the electronic system is active and will therefore be able to control the charging process, supply the refrigerator and monitor other system circuits.

3 System Technical Information

The following section provides further technical information relating to the electrical system. You can also access the supporting technical manual from www.sargentltd.co.uk

3.1 Residual Current Device & Miniature Circuit Breakers

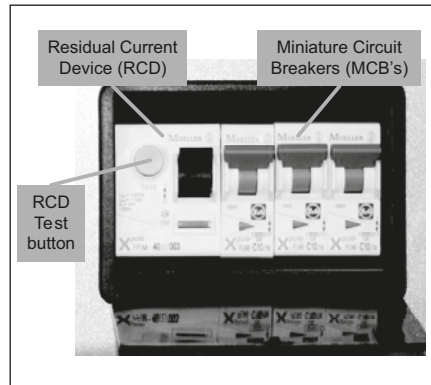

The Residual Current Device (RCD) is basically provided to protect the user from lethal electric shock. The RCD will turn off (trip) if the current flowing in the live conductor does not fully return down the neutral conductor, i.e. some current is passing through a person down to earth or through a faulty appliance.

To ensure the RCD is working correctly, the test button should be operated each time the vehicle is connected to the mains supply (see section 2.4)

The Miniature Circuit Breakers (MCB's) operate in a similar way to traditional fuses and are provided to protect the wiring installation from overload or short circuit. If an overload occurs the MCB will switch off the supply. If this occurs you should investigate the cause of the fault before switching the MCB back on.

The following table shows the rating and circuit allocation for the three MCB's

MCB	Rating	Output wire colour	Description
1	10 Amps	White	230v Sockets
2	10 Amps	White (Yellow for heater)	Extra 230v Sockets / Space Heater
2	16 Amps	Yellow	Alde heating (EC470 PSU Only)
3	10 Amps	Black (Blue for water heater)	Fridge / Water Heater / 12v Charger (internally connected)

3.2 Battery Charger

The EC400 / EC450 system incorporates an intelligent three-stage battery charger / power converter.

During stage 1 the battery voltage is increased gradually while the current is limited to start the charging process and protect the battery. At stage 2 the voltage rises to 14.4V to deliver the bulk charge to the battery. When the battery is charged, the voltage is decreased at stage 3 to 13.6V to deliver a float charge to maintain the battery in the fully charged state. The charger can be left switched on continuously as required.

The battery charger / power converter also provides power to the leisure equipment when the mains supply is connected. This module supplies DC to the leisure equipment up to a maximum of 25 Amps (300 Watts), therefore the available power is distributed between the leisure load and the battery, with the leisure load taking priority as per the following example:

Leisure Load	Available power for battery charging
5A	20A
10A	15A
15A	10A
20A	5A

WARNING: Under heavy loads the Charger case may become hot. ALWAYS ensure the ventilation slots have a clear flow of air. Do not place combustible materials against / adjacent to the Charger

3.3 Leisure Battery

A) Type / Selection

For optimum performance and safety it is essential that only a proprietary brand LEISURE battery is used with a typical capacity of 75 to 120 Ah (Ampere / hours). A normal car battery is NOT suitable.

This battery should always be connected when the system is in use. The PSU is configured to work with standard lead acid leisure batteries, and in most cases is also compatible with the latest range of Absorbed Glass Matt (AGM) batteries. Before fitting non-standard batteries please check that the charging profile described in 3.2 is suitable for the type of battery by referring to the battery documentation or battery manufacturer.

The battery feed is fitted with an inline fuse between the battery and the electrical harness, and is usually located immediately outside the battery compartment or within 500mm of the battery. The maximum rating of this fuse is 20A per battery. If a single battery is fitted to a motorhome, this fuse may be increased to 40A, however if two batteries are fitted each battery should be fused at a maximum of 20A.

B) Installation & Removal

Always disconnect the 230v mains supply and turn the PSU green charger switch to the off position (button out) before removing or installing the battery.

When connecting the battery, ensure that the correct polarity is observed (black is negative [-] and red is positive [+]) and that the terminals are securely fastened. Crocodile clips must not be used.

WARNING: Explosive gases may be present at the battery. Take care to prevent flames and sparks in the vicinity of the battery and do not smoke.

C) Operation / Servicing

Under normal circumstances it should not be necessary to remove the battery other than for routine inspection of the terminals and "topping up" of the battery fluid where applicable. Please see instructions supplied with the battery.

Note: Do not over discharge the battery. One of the most common causes of battery failure is when the battery is discharged below the recommended level of approximately 10v. Discharging a battery below this figure can cause permanent damage to one or more of the cells within the battery.

To prevent over discharge, the EC400-450 system incorporates a battery protect circuit that warns the users and then disconnects the batteries when they fall below set values.

If the power is turned on and the leisure battery level falls below 9V a warning beep will be heard and the leisure battery gauge 10V LED will flash. To cancel the warning, press the levels button.

If the power is turned on and the vehicle battery level falls below 10.9V a warning beep will be heard and the vehicle battery gauge 10V LED will flash. To cancel the warning, press the levels button.

These warnings will not be repeated unless the power switch is turned off and on again. This is to ensure the warning does not become a nuisance.

Battery	Voltage cut off	Action after cut off	Notes
Vehicle	10.9v	Battery selection is changed from Vehicle battery to Leisure battery. If the leisure battery is below 9v then a further warning will occur (see below).	This cut off level is designed to protect the vehicle battery from over discharge. The 10.9v level ensures there is sufficient power in the battery to run the vehicle electronics and start the vehicle. This cut off only applies to power drawn from the battery by the leisure equipment; it will not protect the battery if you leave vehicle circuits switched on, such as the road lights.
Leisure	9v	Power is turned off	This is an emergency cut off level to protect the battery from severe damage. You should not rely on this cut off level during normal operation, but manage your power consumption to a discharge level of 10v. This cut off only applies to power drawn from the battery by the leisure equipment that is controlled by the control panel power switch; it will not protect the battery from discharge by permanently connected equipment.

3.4 12 Volt DC Fuses

WARNING: When replacing fuses always replace a fuse with the correct value. **NEVER** replace with a higher value / rating as this could damage the wiring harness. If a replacement fuse 'blows' do not keep replacing the fuse as you could damage the wiring harness. Please investigate the fault and contact your dealer.

EC450/EC455 POWER CONTROL SYSTEM

The following table shows the fuse allocation for the 15 fuses fitted to the PSU. Please note that fuses are dependant on PSU versions, so not all fuses may be present.

Fuse	Rating	Fuse colour	Description
1	20 Amps	Yellow	Not used in caravan application
2	15 Amps	Blue	Not used in caravan application
3	7.5 Amps	Brown	Not used in caravan application
4	15 Amps	Blue	Not used in caravan application
5	10 Amps	Red	Extractor Fans / Combination Heating Systems
6	10 Amps	Red	12V Sockets / TV Amp / Radio (caravan radio supply)
7	10 Amps	Red	Front Internal Lighting
8	10 Amps	Red	Water Pumps / Toilet
9	15 Amps	Blue	Not used in caravan application
10	10 Amps	Red	Not used in caravan application
11	10 Amps	Red	Bathroom lights
12	5 Amps	Tan	Electronics / Fridge / Alarm
13	5 Amps	Tan	Oven Ignition / Water Heater (where applicable / Separate water heater)
14	10 Amps	Red	Rear Internal Lights
15	25 Amps	White	Charger (fitted internally to PSU)

The following table shows details of the fuse(s) located at the Leisure battery. See also 3.3A

Fuse	Rating	Fuse colour	Description
Battery 1	20 Amps	Yellow	Fuse remotely located near battery

The following table shows details of the fuse(s) located at the Road Light fuse box, on the front wall inside the front bed.

Fuse	Rating	Fuse colour	Description
1	20 Amps	Yellow	Fridge Supply 12V
2	5 Amps	Tan	Left Hand Tail Lights
3	5 Amps	Tan	Right Hand Indicators
4	5 Amps	Tan	Fog Lights
5			Spare location
6	20 Amps	Yellow	Car Battery Supply 12V
7	5 Amps	Tan	Right Hand Tail Lights
8	5 Amps	Tan	Left Hand Indicators
9	7.5 Amps	Brown	Stop Lights
10	5 Amps	Tan	Reverse Lights

3.5 System Status and Configuration display

On the EC449 PSU, the unit contains an LCD display and two control buttons that allow system information to be viewed or settings changed.

Press the top yellow 'select' button to change the item being viewed. Press the bottom red 'change' button to change the setting. Both buttons work on a continuous loop, so if you want to return to an item or setting keep pressing the button until the required item is reached.

3.6 Water System Operation

The control panel pump button operates the internal (onboard) water pump. This pump will draw water from the internal (onboard) water tank (if fitted) or the external water inlet, depending on the position of the manual supply selector valve.

The system also incorporates a separate powered water inlet that can be used with an external filler pump to fill the internal (onboard) water tank (if fitted).

user when the fresh water level drops below 25% or when the waste water level reaches 100%. If the water pump power is turned on and the fresh water level drops to below 25% a warning beep will be heard and the fresh gauge empty LED will flash. To cancel the warning, press the levels button.

If the water pump power is turned on and the waste water level rises to full (100%) a warning beep will be heard and the waste gauge full LED will flash. To cancel the warning, press the levels button. These warnings will not be repeated unless the water pump power switch is turned off and on again.

This is to ensure the warning does not become a nuisance.

3.7 Warnings and Alerts

If the vehicle engine is started whilst the caravan is connected to the 230v supply, a warning beep will be heard. This is to warn you to remove the 230v supply before driving away.

When the vehicle engine is running both the vehicle battery and the leisure battery LED's will flash in unison to indicate that they are connected together and are being charged by the vehicle.

Low water level and waste tank, if the fresh water level drops to below 25% a warning beep will be heard and the fresh gauge empty LED will flash. To cancel the warning, press the levels button. If the waste water level rises to full (100%) a warning beep will be heard and the waste gauge full LED will flash. To cancel the warning, press the levels button.

Low voltage warning and cut off, if the power is turned on and the leisure battery level falls below 9V a warning beep will be heard and the leisure battery gauge 10V LED will flash. To cancel the warning, press the levels button. If the power is turned on and the vehicle battery is selected (being used) and the level falls below 10.9V a warning beep will be heard and the vehicle battery gauge 10V LED will flash. To cancel the warning, press the levels button.

3.8 Common Fault Table

Fault	Possible Cause	Proposed Fix
No 230 volt output from PSU	Connecting lead between the site and Leisure Vehicle not connected	Check and connect lead as per 2.4C
	RCD switched off	Reset RCD as per 2.4D
	RCD not operating correctly	Check supply polarity; if the RCD continues to fail contact your Dealer as there is probably an equipment or wiring fault.
	MCB switched off	Reset MCB by switching OFF (down position) then back ON (up position), if the MCB continues to fail contact your Dealer as there is probably an equipment or wiring fault.
	No or deficient supply from site	Contact site Warden for assistance
	Other fault	Contact your Dealer
Reverse Polarity light is illuminated on PSU	Mains Supply reversed?	The reverse polarity light is designed to illuminate when the Live and Neutral supply has been reversed / crossed over. If the light illuminates there is a problem with the site supply or the cable connecting the supply to your vehicle. The light is designed to work on UK electrical supplies (where the neutral conductor is connected to earth at the sub station). If you are using your vehicle outside the UK this light may illuminate when no fault exists. In these cases consult the site warden for advice.

POWER CONTROL SYSTEM FAULTS

3.8 Common Fault Table

	Generator being used	'The Reverse Polarity warning light is on when using my Generator'. This is a normal side effect when using some types of generator. Instead of connecting the neutral conductor to earth, some generators centre tap the earth connection making both neutral and live conductors 110v above earth. This 110v difference causes the neon polarity indicator to illuminate. In most cases it is still safe to use the generator, but please consult the generator handbook for further information.
Control Panel Problems	Control Panel has no display	Check batteries and fuses, turn PSU shutdown switch and charger switch on and ensure mains supply is connected. Check control panel connecting lead at PSU and behind Control Panel. Contact your Dealer
	12v Power turns off	Battery protect feature has operated to protect the Vehicle battery and or the Leisure battery. See 3.4C Engine has been started, all equipment has been disconnected to meet EMC requirements. See 2.7
	Control Panel locked / erratic function	Observe control panel handling instructions Control panel software may have crashed. Reboot control panel by turning off the PSU isolate switch. Wait 30 seconds then turn the switch back on.

No 12 volt output from PSU	No 230v supply	Check all above
	Charger not switched on	Turn charger switch on, switch will illuminate
	Battery not connected and / or charged	Install charged battery as per 3.4
	Power button on control panel not switched to on	Turn power on at control panel
	Battery flat / Battery fuse blown	Recharge battery, check fuses, check charging voltage is present at battery
	Fuse blown	Check all fuses are intact and the correct value fuse is installed as per fuse table
	Equipment switched off / unplugged	Check equipment is switched on and connected to the 12v supply
	PSU overheated / auto shutdown operated	Reduce load on system. Allow PSU to cool down. PSU will automatically restart when cool.
	Other fault	Contact your Dealer
Pump not working	Fuse blown	Replace fuse with correct value as per fuse table.
	Pump turned off	Turn pump on by pressing the pump button at the control panel.
	Setting incorrect	Both the internal and external pump feeds are controlled from the control panel. To alter the setting of the pump switch see section 3.8 Ensure the setting matches your desired requirement.

3.11 Contact details

Sargent Electrical Services Limited, provide a technical help line during office hours. Please contact 01482 678981 if you require technical help. For out of hour support please refer to the tech support section of the Sargent web site www.sargentltd.co.uk

POWER CONTROL SYSTEM FAULTS

4 Technical Data & Approvals**4.1 Caravan Equipment –****EC440,445,448,449 PSU & EC441,442,443,446,447,451 Control Panel**

Outline Specification		
INPUT 230v	230 Volts / 0 to 16 Amps	+ / - 10%
OUTPUT 230v	RCD protected, 3 x MCB outputs of 10A Separate switched channels for water heater, space heater and charger	
INPUT 12v	2 x 20A battery inputs via 2 x 4 way connectors	
OUTPUT 12v	25A total output via multiple switched channels protected by 14 fused outputs	
CHARGER	Input 220-240 Volts AC +/- 10%, Frequency 50 Hz +/- 6%, Current 3A max. DC Output 13.6 to 14.4 Volts nominal, Current 25 Amps max (300 Watts). Overall size (HxWxD) 50 x 250 x 135mm	Fixing centres 128*128mm 1.2kg
Signal INPUT	4 x Fresh water level, 1 x Engine running, plus multiple vehicle connections	Fresh water negative sensed
Data IN / OUT	CANBUS Data communication and power to Control Panel via 6 way connector	
IP rating	IP31	
Operating temperature	Ambient 0 to 35°C Centigrade PSU case temperature with full load 65°C Max	Automatic shutdown and restart if overheated / overloaded
Dimensions		
EC449, EC448 PSU	Overall size (HxWxD) 395 x 205 x 170mm Clearances 75mm above, 50mm left & right	Weight 3.05 Kg
EC442, EC447 Control Panel	Overall size (HxWxD) 87 x 250 x 15mm Cut-out size (HxW) 70 x 233mm	Fixing centres 130*75mm Weight 114 g

4.2 Approvals

System: BSEN 1648-1, BSEN1648-2 compliant, BS7671: 2008 compliant

Residual Current Device: RCD 40A 30mA trip to BS EN 61008

Miniature Circuit Breakers: MCB's type C 6000A breaking capacity to BSEN 60898

Electro Magnetic Compatibility (EMC) directive 2004/108/EC Certificate CE20071224-1

Integrated Charger: BS EN 60335-1/2.29, 2006/95EC, IEC61000-3.2/3:1995, 1.

Low Voltage Directive: 2006/95EC TUV-014900-A1, EN55022, Class B, EN55024/Level 2

BATTERY BOX

THETFORD BATTERY BOX

The Thetford Battery Box is intended to accommodate an auxiliary battery in your caravan. The Battery Box has a CE socket to connect to a 230 V power supply. Inside the Battery Box there is the option to fit several sockets and outlets.

WARNING:

- Use precaution when mounting the battery, as batteries contain acid liquids which can cause severe injuries and damage when handled incorrectly. Refer to the instructions on the battery.
- No smoking is allowed in the area of the Battery Box!
- Please note that the CE socket has a max of 16 amp.
- The Thetford Battery Box is designed for use with foot mounted batteries. These are recognisable by the rim around the bottom edge of the battery. This rim will locate against the back wall of the Battery Box and the angle metal bracket, which is screwed into place when the battery is fitted. The depth of the battery including rim should be between 173mm and 175mm.
- This product meets the latest version of the EN 1648 part 1 and 2 standard.

Before placing the battery inside the Battery Box, the battery should be placed into the Soft Tray and rested on the ground adjacent to the Battery Box. Carefully connect the electrical wires (the red cable attaches to the + pole and the black cable to the - pole of the battery).

Note! Incorrect connection of the cables will cause a short circuit with potential hazardous consequences.

After mounting the terminals, lift the battery together with the Soft Tray into the middle of the Battery Box compartment. Push the Soft Tray with battery to the back of the Battery Box, into the safeguard bulge.

If necessary shift the Soft Tray to the right or left until the battery is in place in the safety area (see photo 1).

The battery is located in the compartment by the manual clamping plate. This has to be screwed to the front of the box (screw is enclosed in package).

Please ensure that the Soft Tray is pulled up tightly (to remove creases) before the plate is tightened. The rounded edge of the clamp prevents damage to the Soft Tray. Do not apply extreme force to the screw.

When attaching the 230 volt cable on the CE socket, the maximum recommended thickness of the cable is 10 mm. When closing the door, the attached cable is to be fed through the slot at the bottom right of the door.

The maximum battery size that can be fitted is 225mm high (including terminals) x 175mm deep x 353mm wide. The depth and width dimensions include the rim around the bottom used for securing the battery.

NOTE: Batteries that are not foot mounted, ie. without a rim can still be fitted, but check first that they will fit within the battery box and can be secured before purchasing.

NOTE: The battery box door is designed to grip the 230v cable to avoid damage to the inlet point if pulled.

**Cleaning and maintenance**

- Use protective clothing and glasses when handling a leaking battery, and avoid direct contact to the skin, eyes and respiratory organ.
- Should a battery leakage occur, please act according to the instructions supplied by the manufacturer of the battery. Act with caution as caustic substances are present in the battery.
- Always remove the battery and the power cable before carrying out any maintenance of the product.
- Before removing the clamps switch off all appliances.
- Use a soft cloth or sponge and a non-acid/abrasive detergent when cleaning the Battery Box and Soft Tray.
- To check if any acid is present in the Soft Tray, simply press it softly. A strong smell from the Soft Tray may also indicate spilled

BATTERY INSTALLATION

acid. Always treat spilled battery acid as hazardous waste. Dispose of spilled battery acid according to the local and national regulations.

- Before the camping season or extensive travelling, check the Soft Tray for faults and replace if necessary.
- The cleaning of the Battery Box and Soft Tray should only be done after all power sources have been switched off, in order to prevent a hazardous situations.

BATTERY INSTALLATION

Under normal circumstances it should not be necessary to remove the battery other than for routine inspection of terminals and 'topping up' if required.

WARNING: Explosive gases may be present at the battery. Take care to prevent flames and sparks in the vicinity.

Your caravan has been fitted with an in-line fuse between the battery terminal and caravan harness. It is recommended that the fuse rating fitted in this location does not exceed 20 amps.

WARNING: Switch off all appliances and lamps before disconnecting the battery.

Smoking is prohibited around the battery compartment.

To preserve the life of your leisure battery and charger please observe the following:

- Do not leave all 12V appliances powered at the same time as this will drain your leisure battery more rapidly.
- If all 12V appliances must be powered together, ensure the battery is 'in-circuit' and that the battery charger is turned on.
- For optimum performance use the transformer/charger unit with a leisure battery attached.

SOLAR PANEL AND GENERATOR

Battery

It is recommended that a good quality rechargeable leisure battery is always in circuit when the system is in use.

A deep cycling heavy duty 12V battery should be purchased to provide power for lights and other electrical appliances.

A proprietary brand leisure battery with a minimum of 85 Amp capacity is recommended.

Note: 85 Amp batteries and above should be checked dimensionally before purchasing, to ensure fitment within the battery compartment, as brands vary in size.

It should be remembered that batteries suitable for the electrical demands of a caravan differ in design from those for use with a car, and whilst the system may operate with a car battery it is strongly recommended that only a leisure type battery, maintained in good condition is used. The battery should be kept topped up at all times if required.

Note: Some models may have more than one 12V socket fitted, the 6 Amps indicated is available from the 12V socket provided no other 12V socket is used at the same time.

SOLAR PANEL CONNECTION POINT (where supplied - model specific)

A connection point has been included in the caravan electrical harness to take a 12V supply from an aftermarket solar panel (or similar device), to the caravan leisure battery.

The solar panel must provide a fused and regulated output in order to connect to this point. The connection point can be found inside the caravan adjacent to the battery box, in close proximity to the battery box fuse. Through the floor close to the battery box is a cable pass through, allowing a pair of wires from an externally located device to pass from exterior to interior to meet the connection point. This cable pass through will be capped both internally and externally with a cable entry gland.

A kit of parts is available from your caravan supplier which provides the mating half of the connection point. (The White rectangular connector found inside the caravan is a two way JST-LR type connector). For further assistance in identifying the connection, wire colours leading to the connector are detailed in the wiring schematic in your caravan service book.

GENERATOR USAGE

Caution should be used before connecting a generator to your caravan.

WARNING: Never start or stop the generator while electrical loads are connected and switched on. Start the engine, let it stabilise, then connect the electrical load. To stop engine, disconnect the electrical load and let engine stabilise before switching off.

Whilst some generators use inverter technology, others use a more basic principle to generate the 230v supply. Preference should be to choose a generator which produces a consistent sinusoidal wave form with accurate voltage control.

The reverse polarity warning light may illuminate when using a generator. This is a normal side effect when using some types of generator. Instead of connecting the neutral and live conductors 110v above earth. This 110v difference causes the neon polarity indicator to illuminate.

In most cases it is safe to use a generator, but please consult the generator handbook for further information.

HABITATION RELAY & EXTERIOR 230V SOCKET

HABITATION RELAY

Habitation relays are fitted to caravans by manufacturers to comply with the following legislation:

1. The Road Vehicles (Construction and Use) Regulations 1986 Regulation 60 - Radio interference suppression
2. Council Directive 72/245/EEC of June 20, 1972 amending for the purpose of their adaptation to technical progress, relating to the radio interference (electromagnetic compatibility) of vehicles and Council Directive 70/156/EEC on the approximation of the laws of the Member States relating to the type-approval of motor vehicles and their trailers.

A habitation relay must be fitted by manufacturers, safe guarding the consumer. The purpose of the relay is to disable non-homologated appliances/components whilst the vehicle is in transit.

Unintentional electromagnetic energy can be created by non-homologated devices within the habitation compartment, which could cause a malfunction of the base vehicles electronic systems/components, including safety critical items such as air bags, ABS braking etc.

EXTERIOR 230V SOCKET

The Bullfinch recessed electric socket is designed to give you a convenient electrical access point on the outside of the caravan, which is completely protected from the weather, even when in use.

With the caravan stationary and connected to a 220v/240v supply, raise the front cover of the socket and insert the plug of the equipment to be used. Close and latch the cover into place to provide a weatherproof seal.

Please remember that the equipment plugged into the socket may or may not be weatherproof.

To disconnect equipment, raise socket cover and remove plug, then close and latch the

cover into place to ensure a weatherproof seal.

Before moving the caravan from a pitch ensure that all accessory points are disconnected and latched in the closed position to prevent the ingress of water or other foreign matter from causing damage to the point or any of the caravans services.

Any item plugged into this socket will be supplied by the same 10A breaker (MCB) as the other items plugged into sockets within the caravan. Please take into account the total loading placed on the socket circuit and the site supply before switching equipment on. The socket should be used to power a single appliance with an appropriate power consumption rating – the socket is NOT suitable for use as a supply to power an adjacent caravan or motorhome.

Mobile Alarm System Operation (Stinger 310 Alarm).....	88
Truma Ultrastore water heater operating instructions	92
Truma Ultrastore water heater fault finding	95
Truma S 3002 auto space heater	96
Teb fan	98
Truma Ultraheat additional electric heating	98
ALDE Compact 3010 Quick Start Guide	100
ALDE Compact 3010	101
Thetford absorption refrigerators	118
Cooker 3 burner and hotplate	129
Cooker 3 burner gas hob (Sprite only)	133
Microwave oven	137
Thetford C250 CWE cassette toilet	139
Thetford C200 CW & C200 CWE cassette toilet	143
Caravans with external BBQ point	148
Caravans with TV inlet in battery box	149
Status 530 directional TV and FM radio antenna	150
Bedding	151
Softrollo Blinds (Seitz)	153
Doorscreen	153
Roof lights	153
Windows	154
Heki-2 roof light (Seitz)	154
Mini Heki rooflight	154
Care of laminate tops, tables, furniture and doors	155
Doors	155
Tables	155
Table storage	155
12V reading lamp	156
Trigger shower heads	156
Fixing of awnings	156
Paint colour reference.....	156
Drop down TV mechanism	156
Front locker and sunroof.....	157
Step on hitch cover	157
Cycle racks.....	157
Caravan motor mover.....	157

The instructions covering fitted equipment to your caravan were correct at the time of going to print. Owners handbooks are updated annually and we take great care to try and ensure their accuracy. However, the Swift Group Limited cannot accept responsibility for any changes that may be made in specification or operating instructions to the equipment described in this section after the time of going to press.

Every care is taken to ensure that the information provided in this handbook is correct and easy to understand.

Separate manufacturers' leaflets on many of the components are also included in the Owner's Pack provided with this caravan and we recommend that you compare the instructions in the handbook with the component manufacturers literature, to ensure the information provided is as accurate as possible.

If you are in any doubt as to how to operate the equipment in your caravan, please contact the component manufacturer's service department on the telephone number shown on their component leaflet. If you remain in any doubt, please contact your supplying dealer.

MOBILE ALARM SYSTEM STINGER 310 ALARM



Introducing the new Sargent STINGER 310 series modular alarm system.

Based on new technology and a two year design process, the Stinger 310 incorporates ideas and feedback from users and experts throughout the caravan and security industries.

Designed to be modular, the system can be expanded by a forthcoming range of wired and wireless accessories.

To ensure your STINGER 310 system is operated correctly, please read all sections of these instructions before attempting to use the alarm. If you are unsure of any content, please contact your supplier in the first instance or the manufacturer direct.

Operation - using the key fob

Each STINGER 310 is supplied with two key fob style radio controllers, which are used to operate the alarm system. Each key fob has four buttons which can be used as follows;



LED Torch button

Press and hold the button to use the torch for night time convenience



Arm / Disarm button

Press and release the button to arm the alarm (one beep)

Press and release the button to disarm the alarm (two short beeps)

To arm the alarm without the PIR movement sensor (if you leave pets inside etc)

Press and hold the arm button and release after you hear one beep followed by two beeps



Awning Light button
(model specific)

Press and release the button to turn the awning light on or off (note: awning light control is an optional feature not present in all caravan models)



Programming Mode button

Press and hold the button for 10 seconds to access the 3 programming modes, which are indicated by series of long beeps, as follows:

One long beep - Tilt sensor sensitivity adjustment

Press the arm/disarm button to select the required setting. 1 beep = low sensitivity for windy conditions. 2 beeps = standard sensitivity (default). 3 beeps = High sensitivity. Press the program mode button to move to the next setting.

Two long beeps - Beeper volume

Press the arm/disarm button to cycle through the 7 available volume levels. When you are happy with the selected volume, press the program mode button to move to the next setting.

Three long beeps - PIR movement detector sensitivity

Press the arm/disarm button to select the required setting / pulse count. 1 beep = high sensitivity 2 beeps = standard sensitivity (default). 3 beeps = Low sensitivity for hostile environments.

Press the program mode button again to exit programming mode, which is indicated by one extra long beep.

OPERATION - THE PIR INTERNAL MOVEMENT SENSOR

The STINGER 310 comes complete with a 120° Passive Infra Red (PIR) internal movement sensor that detects body movement within the vehicle.

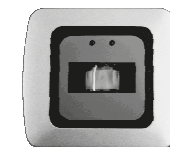

If you are leaving pets within the vehicle the system should be armed without the PIR sensor active (see key fob arm/disarm section) to prevent your pet from triggering the alarm.

Please be aware that direct sunlight onto the PIR lens, or extremes of temperature (above 30 deg C) may affect the operation of the detector. Always ensure roof light blinds are closed if sunlight could shine directly onto the PIR.

OPERATION - THE TILT SENSOR

The STINGER 310 incorporates a new electronic tilt and motion sensor with automatic calibration and easy sensitivity adjustment from the key fob. This feature provides excellent tilt detection with no moving parts.

The tilt sensor works automatically and does not need adjustment for normal use even if you park on a steep incline. The sensitivity of the sensor can be adjusted as described in the key fob programming section.

OPERATION - AWNING LIGHT (MODEL SPECIFIC)

When the STINGER 310 alarm system is armed or disarmed the Awning light will be activated for a period one minute to provide illumination whilst entering or exiting the caravan. The Awning light can be turned off during this period by pressing the Awning light button on the key fob if required. (Note: awning light control is an optional feature not present in all caravan models)

ALARM

The Awning light can be turned on or off at any time by pressing and releasing the Awning light button.

BATTERY - SYSTEM BASE UNIT

The STINGER 310 system unit uses a special 4.8 volt Nickel Metal Hydride battery pack that supplies backup battery power to the system should the supply from the leisure battery fail or be disconnected.

It is recommended that the alarm system is permanently connected to a 12 volt supply. When fully charged the battery will provide approximately 6 months stand-alone operation, depending on temperature conditions. It is recommended that this battery pack is replaced every 3 years.

Before placing your caravan in storage please ensure the caravan has had a fully charged leisure battery fitted or the mains charger switched on for at least 14 days prior to storage to ensure the internal backup battery is fully charged. It is recommended that a leisure battery remains connected to the caravan during storage.

Always dispose of old batteries in accordance with local regulations.

BATTERY - KEY FOB

The STINGER 310 key fob controllers use two lithium button cells (CR 2032) in each key fob. Please note that excessive use of the LED torch will reduce the life of the batteries considerably.

To replace the batteries, firstly remove the four cross head screws from the underside of the fob, then pull apart the two halves of the fob. Remove the used batteries from the lower half of the case, then insert the new batteries in the same manner, noting that the battery positive faces away from the green circuit board. Now reassemble the fob casing and refit the screws, taking care not to over tighten.

ALARM SIREN

The STINGER 310 contains a dual sounder unit that provides the loud alarm siren and the volume adjustable beeper sound.

When the alarm is triggered the siren will sound for 2 minutes. Following the 2-minute period the alarm will then deactivate for 15 seconds and then rearm.

The alarm siren can be turned off at any point by pressing the key fob arm/disarm button.

When the alarm is disarmed the Beeper will sound two beeps to confirm the disarm. If the alarm has been triggered during the armed period the beeper will sound three beeps if the PIR triggered the alarm or four beeps if the Tilt Sensor caused the alarm. If you hear multiple pips (short beeps) when you disarm the alarm, this indicated that the internal backup battery is low and therefore should be charged.

The beeper volume can be adjusted using the key fob programming feature described earlier.

SYSTEM SPECIFICATION

System base unit:

- Supply voltage 6 to 15v DC
- Supply current 500mA max 5mA typical
- Operating temperature -5 to +30 deg Celsius
- Battery capacity 9Ah at 4.8v
- Siren output 110dB +/- 10% @ 1M
- Comprehensive interface connector (details on request)

PIR movement sensor:

- Range 120 deg x 6M

Key fob controller:

- Range 6M typical
- Battery 2x CR2032 lithium button cell
- Typical battery life 1 year

SPARE PARTS & SERVICE

The STINGER 310 system is supplied with two key fob controllers as standard, but can accommodate up to four controllers per system. Extra fob can be purchased from your supplier or direct from the manufacturer, and can be added to the system by following a simple procedure.

For accessories, interface harnesses, installation documentation, spare parts, local supplier contact details or other service information please contact: Sargent Electrical Services Ltd. service desk on 01482 678981 during normal office hours.

Further technical information is available at www.sargentltd.co.uk

For your reference

For future reference it may be useful to note your alarm system serial number below, which can be found on the sticker attached to the alarm system base unit.

Serial number:

.....

TRUMA ULTRASTORE

Equipment Specification

For details on type of equipment fitted in your caravan, please refer to the Sales Brochure or Dealer.

IMPORTANT

To maximise the use and life of all fitted equipment in your caravan it is essential that any accompanying manufacturers' literature is read fully. All recommended maintenance and preparation procedures should be followed. The information provided in this handbook is only intended as a guide. If in any doubt consult your manufacturer appointed dealer, particularly before attempting to install EXTRA EQUIPMENT.

Notice: In the interest of safety, replacement parts for an appliance shall conform to the appliance manufacturer's specifications and should be fitted by them or their authorised agent.

TRUMA ULTRASTORE WATER HEATER OPERATING INSTRUCTIONS

Attention: Before using for the first time, it is essential to flush the entire water supply through with clean warm water. Always mount the cowl cover when the water heater is not being operated! Drain the water heater if there is a risk of frost!

There shall be no claims under guarantee for damage caused by frost!

When connecting to a central water supply (rural or city connection) or when using more powerful pumps, a pressure reducer must be used which prevents pressures of greater than 2.8 bar occurring in the Ultrastore.

Filling the Truma Ultrastore with water

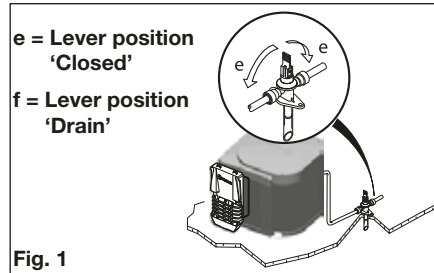

1. Check that the drain valve in the cold-water intake is closed. Lever should be in the horizontal position (e).
2. Open the hot tap in the bathroom or kitchen with pre-selecting mixing taps or single lever fittings set to hot.
3. Switch on power for water pump (main switch or pump switch). Leave the tap open to let air escape while the water heater is filling. The heater is filled when water flows out of the tap.

Note: residues of frozen water can prevent filling if there is a frost. The water heater can be defrosted by switching on the heater for a short period (max 2 mins). Frozen pipes can be defrosted by heating the room.

Note: If just the cold water system is being used, without water heater, the heater tank is also filled up with water. Therefore, order to avoid damage through frost, the water contents must be drained by opening the drain valve when the system is no longer in use.

Draining the water heater

1. Disconnect power for water pump (main switch or pump switch).
2. Open hot water taps in bathroom and kitchen.
3. Open safety/drain valve: Lever in vertical position, (Fig. 1) position (f).
4. The water heater is now drained directly to the outside via the safety/drain valve. Check that the water contents have been completely drained (10 litres).

Gas operating instructions

Attention: Never operate the water heater without water in it!

1. Remove cowl cover.

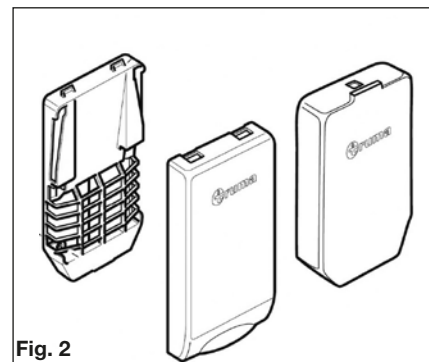

2. Open gas cylinder and open the gas shut off valve at the manifold.
3. Turn on the heater by moving the central rocker switch to the 50°C or 70°C position as desired. (Fig 3).

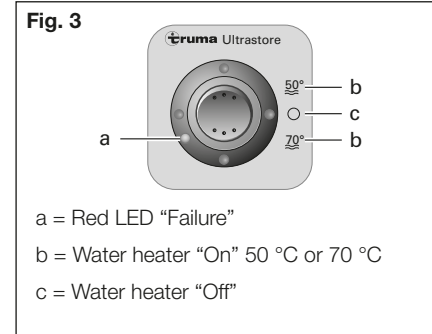

4. After 5 seconds clicking sound will be heard from water heater, as boiler attempts to light
Outer collar (a) in control module will turn Red if boiler fails to light - If boiler does fail to light, turn switch back to central position (c), wait 5 minutes, and then repeat step 3.

5. If there is air in the gas supply line, it may take up to a minute before the gas is available for combustion. If the appliance switches to "Failure" during this period, switch off the appliance - wait 5 minutes - and switch on again!

Switching off (gas operation)

Switch off the water heater by moving the rocker switch to the central position. (Fig 3).

Drain the water heater if there is a risk of frost!

If the water heater is not to be used for a longer period, mount cowl cover and close the heater gas shut off valve at the manifold.

There shall be no claim under guarantee if this point is not observed.

Always remove the cowl cover prior to operating the water heater!

Red indicator lamp "Failure"

The red indicator lamp (d) lights up if there is a failure.

The reason for such an indication is, for example, no gas available or air in the gas supply system, triggering of the excess temperature monitor etc. To unlock, switch off the appliance, wait 5 minutes, and switch on again.

In event of faults, always contact the Truma Service on Tel: 01283 586020.

Electrical Operating Instructions

1. Ensure that the heater tank is full of water before operating the unit on electric power.
2. Turn on the electric heating element by operating the water heater switch on the power supply unit. See page 68
3. At the Ultrastore control (Fig 4.), move the rocker switch from the central off position (h), to either 850W or 1300W (g). The 850W

TRUMA ULTRASTORE

setting will take longer to heat the water, but less power than the 1300W setting.

- Once a setting has been selected, the electric element within the water heater will turn ON and OFF automatically, to aim to regulate the water temperature at 70°C. As long as there is a suitable mains supply present, and the water system is primed, there is no requirement to switch the water heater 230V element off.

Fig. 4

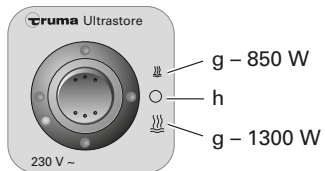

g = Water heater 'on' 850W or 1300W
h = Water heater "Off"

Note: The water temperature cannot be selected, automatic temperature limitation at approx. 70°C. For a faster heating up period the appliance can be simultaneously operated with gas and electrical power.

The electrical heating rod is fitted with an excess temperature cut-out. In the event of a fault, switch off at the operating element. Check water content, refill if required (close drain valve). Wait 10 minutes, then switch on again.

Maintenance

We recommend the Truma system care set for cleaning, disinfecting and looking after the boiler. Other products – in particular products containing chlorine – are unsuitable.

To avoid infestation by micro-organisms, the water content must be heated to 70 °C at regular intervals. Clean the device and the ventilation slits with a dry and fluff free cloth.

Fuses

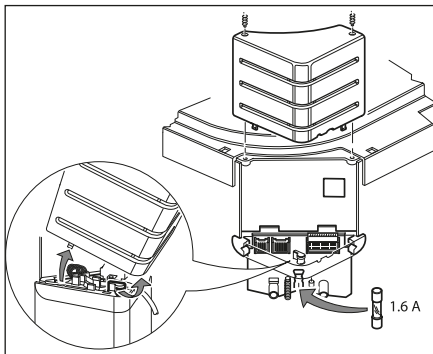

The water heater 12 V fuse is on the electronic control unit on the water heater.

Note: Only replace the miniature Fuse on the p.c.b. with a fuse of the same type: 1.6 A, EN 60127-2-3 (slow action). If there is a defect in the electronics, return the control p.c.b. well padded. If you fail to pack it correctly the guarantee shall no longer be valid. Only use original Truma Ultrastore control p.c.b.'s as spare parts!

TRUMA ULTRASTORE TROUBLE SHOOTING

SYMPTOM	CAUSE	RECTIFICATION
<p>Gas operation</p> <p>When switching on, the heater does not operate.</p> <p>When switching on, the heater does not operate and the red lamp lights up after approx. 30 secs.</p> <p>Heater operates for a prolonged time and then the red lamp lights up.</p>	<ul style="list-style-type: none"> No 12 V supply voltage. Window open. Cowl cover fitted. No gas supply. Incorrect gas pressure. Air in the gas supply. Over temperature thermostat operated. 	<ul style="list-style-type: none"> Check the power supply (operation voltage min. 10.5 V). Check the water heater fuse (refer to maintenance "Fuses"). Close any windows above the cowl. Remove cowl cover and / or clear any obstruction. Check gas valves and gas bottle. Check gas valves and gas bottle. To unlock (and purge air), switch off the appliance, wait 5 minutes, and switch on again. Check water content, refill if required (close drain valve). To unlock, switch off the appliance, wait 5 minutes, and switch on again.
<p>Electrical operation</p> <p>When switching on, the heater does not operate.</p>	<ul style="list-style-type: none"> No 230 V supply voltage. Over temperature thermostat operated. Too slow warm-up in position 850 W 	<ul style="list-style-type: none"> Connect the motorhome to the site supply and / or check residual current circuit breaker. Check water content, refill if required (close drain valve). The electrical heating element is fitted with an excess temperature cut-out. In event of a fault, switch off at the control panel, wait 10 minutes, then switch on again. Please contact the Truma Service.
<p>Water supply</p> <p>Water drips from the safety/drain valve.</p> <p>When opening the cold water tap, hot water tap comes out.</p>	<ul style="list-style-type: none"> Water pressure too high. Hot water flows back through the cold water supply. 	<ul style="list-style-type: none"> Check water pressure (max. 2.8 bar), use a pressure reducer when connected to central water supply. Fit a no-return valve in the cold water supply (refer to installation instructions "Water connection").

If fault persists please contact the nearest Truma Service (see Truma Service Booklet or www.truma.com).

TRUMA S3002 AUTO SPACE HEATER

TRUMA S 3002 AUTO SPACE HEATER

Instructions for heaters fitted with automatic ignitor

Switching On

1. Open the valve on the gas cylinder. Open shut off valve in gas supply line.
2. Turn control knob to thermostat setting 1-10 and press it down as far as the stop. At the same time keep operating the Piezo ignitor rapidly until the flame ignites.
3. Keep the control knob depressed for a further 10 seconds to allow the safety pilot to operate.
4. (Piezo only) Watch through the flame window for another 10 seconds to make sure that the flame does not go out through air in the supply pipe (caused by the valve being closed or changing the cylinder).

Attention: Always wait at least 2 minutes before attempting to re-ignite, otherwise there is a risk of blow backs (misfiring). This also applies if a working heater goes out has to be re-lit.

Automatic Ignitor

Prior to first ignition, make sure that the batteries have been inserted; observe correct fit battery cassette (see changing batteries, page 97).

Thermostat

Set the required room temperature at the control knob (numbers 1-10). For an average room temperature of approx. 22°C we recommend setting:

3-5 Without the Trumavent Fan (switched on)

4-8 With the Trumavent Fan

Switching Off

Set control knob to "0". If turning off for a long period of time, close the quick-acting valve in the gas supply line. Close valve of gas cylinder.

Important Operating Notes

1. If the gas supply line is filled with air, it may take up to a minute before the gas becomes available for combustion. During this time depress the control knob and continuously operate the Piezo ignitor until the flame ignites.
2. You will have to find out the exact thermostat setting yourself, depending on how much heat you need.
3. Repairs are only to be carried out by a competent service engineer.

Attention: A new O-ring must always be installed after dismantling the exhaust duct.

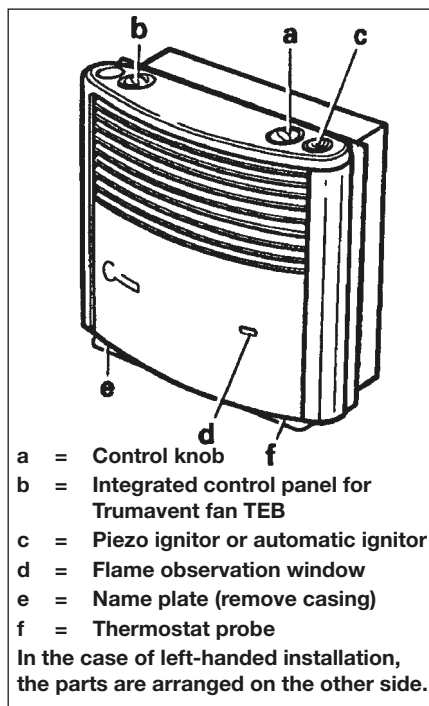

4. Any alteration to the appliance (including exhaust duct and cowl) or the use of spare parts and accessories, which are important to the function of the heater and which are not original Truma parts, as well as the non-observance of the installation and operating instructions, will lead to the cancelling of the guarantee and exclusion of liability claim.
5. During the initial operation of a brand new appliance, a certain amount of fumes and a slight smell may be noticed for a short while. Remedial action is to immediately run the heater at maximum output and to ensure adequate room ventilation.
6. In winter, before switching on the heater, remove all snow from the cowl.
7. Inspect the exhaust duct and all connections at regular intervals and always whenever there is a blow back (misfire). It is essential that the exhaust duct is installed so that it slopes upwards over its whole length and is securely fixed with several clamps. Never place any object on the exhaust duct, since this could result in damage. The exhaust duct connection to both the heater and the cowl must be firm and well sealed.

Do not operate heaters with incorrectly fitted or damaged exhaust ducts.
8. Never allow the warm air outlet on the heater to be obstructed in any way. For instance never hang washing on or in front of the heater to dry. Misusing your heater in this way could cause serious damage from overheating. Do not place flammable objects near the heater. Please follow these guidelines in the interest of your own safety.
9. If the burner makes an unusual noise or if the flame lifts off while burning, it is likely that the regulator is faulty and it is essential to have it checked.
10. Cleaning (with switched off appliance): It is recommended that at least once a year, before the heating season starts, you remove any dust that has collected on the heat exchanger base plate.

Technical Data:

Type of gas:	Liquid gas (propane/butane)
Operating pressure:	30mbar (28mbar butane, 37mbar propane)
Rated thermal output:	3400W
Gas consumption:	30-280 g/h
Product Ident.	No: CE-0085AP0325

Automatic Ignitor

Power consumption:	50 MA (ignition) 0.01 MA (monitoring)
Operating voltage:	3V

Changing of batteries

Changing the Batteries on the Automatic Ignitor

Only change the batteries with the heater switched off.

Always insert new batteries at the beginning of the heating season.



Remove front of heater retaining screw, located through centre of black grill. Unclip front of heater, slide up battery cover to reveal battery. Change the batteries. Observe plus/minus.

Only use temperature resistant (+70°C), leak-proof Mignon round cells (LR 6, AA, AM 3, Art. no. 30010-23600). Other batteries could lead to malfunctions!

WARNING: Do not cover or obstruct the front of the fire as this can ignite and/or divert heat downwards onto the floor coverings and cause permanent damage or fire.

TEB FAN

TEB FAN

Always observe the operating instructions prior to starting!

The vehicle owner is responsible for the correct operation of the appliance.

Repairs are only to be carried out by a qualified person

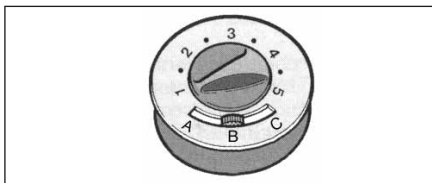

a = Manual control

(e.g. for ventilation) Adjust desired output at the control knob.

b = Off

(or automatic operation/ heating with heaters Trumatic S 3002 K and S 5002 K)

c = Automatic operation

(Heating) The output steadily adjusts to the respective heat emission of the heater. The maximum output can be limited at the control knob, as required. The regulating between this value and slow running is carried out automatically.

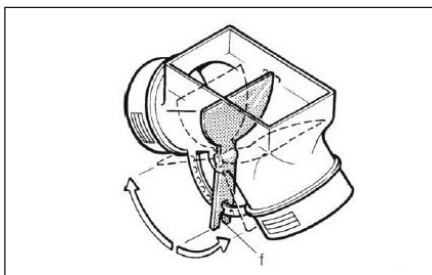

The quantity of air can be individually adjusted at the air flap (f), for warm air distribution.

In centre position 50% of the warm air is distributed to each outlet.

Use the fan duct with 72 mm and if the fan ducts are of different lengths or on sides with a greater heat requirement. This means that the air output can be used to the full on this side. By adjusting the air flap (f) the quantity of air can be increased individually. This means that the air out-put on the other side is reduced.

If the air output drops or the operating noise increases, the fan impeller wheel may be severely soiled.

Cleaning

(With switched off appliance!) We recommend removing dust which has collected on the heat exchanger and base plate of the heater and on the impeller wheel of the Trumavent fan, once a year before the heating season starts. Clean the impeller wheel carefully using a brush or tooth brush.

**TRUMA ULTRAHEAT
ADDITIONAL ELECTRIC HEATING**

For Trumatic S 3002 heaters

Function description

Truma-Ultraheat is an additional 230V electric heater for the LPG heater models Trumatic S 3002/S 5002.

Heater operation is basically possible with gas only, electricity only or simultaneously with electricity and gas.

When using simultaneously the electrical unit will switch itself off before overheating occurs as a result of the stronger gas burner.

When using electrical only we recommend to set the fan control on position 3 (manual or auto), remembering to set the output level to 2000W (ensure that the fuse protection for the power supply of the camp site is sufficient).

If more than 2kw are required (heating up/cold temperatures) you must refer back using gas operations as the 230V electrical operation is a secondary heater only.

The electric heater can also be operated without the Trumavent fans.

TRUMA S3002 AUTO SPACE HEATER

WARNING: Surfaces become hot in use, guards provided do not give full protection to the young or elderly.

Operating instructions

Before operating the heater for the first time it is essential to observe the operating instructions, enclosed with the heater.

Control panel with thermostat

- a = Rotary switch "Off"
- b = Rotary switch "On" power settings:
500 - 1000 - 2000 W
- c = Rotary control knob for room temperature (illuminated by green indicator lamp "operation")

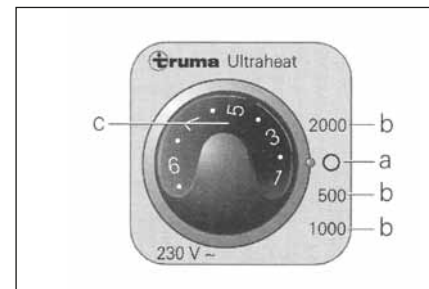

Switching On

Attention: Before switching on, ensure that the fuse protection for the power supply of the campsite is sufficient for the selected power setting (b) (see Technical Data).

Important: The electric feed line for the caravan must be fully unwound from the cable drum.

1. Turn on 'Space Heater' located on PSU.
2. To switch on, turn the rotary switch to the desired output level (b).
3. Set rotary control knob (c) to the desired room temperature.

The thermostat setting on the operating element (1-9) must be determined individually depending on the heating requirement and the type of vehicle. For an average room temperature of about 23°C, we recommend a thermostat setting of about 6 - 8.

The electric heater can also be operated without the Trumavent fans.

If the heater is operated simultaneously with electricity and gas, the electrical unit will switch itself off before overheating occurs as a result of the stronger gas burner.

Switching off

Switch the heating system off at the rotary switch (a).

Turn off 'Space Heater' switch on PSU.

Important operating notes

1. Repairs may only be carried out by a qualified LPG engineer.
2. The heater's hot air outlet should under no circumstances be blocked. Never hang clothes or similar in front of or on top of the heater to dry. This could cause serious damage to the heater as a result of overheating. Do not place inflammable materials near the heater! Please observe these instructions for your own safety.
3. The performance of the room thermostat will be affected if temporarily covered or obstructed
4. When operating a brand-new heater for the first time (or after it has been idle for a lengthy period) you may temporarily notice a slight smoke and smell. We advise running the heater at full power and thoroughly ventilating the room.
5. Any modifications to the appliance or the use of spare parts and accessories important for operation which are not original Truma parts, or non-observance of the instructions for installation and use will result in the guarantee becoming invalid and no liability will be assumed.

Furthermore the approval for operating the appliance will become invalid and in some countries also the approval for operating the vehicle.

The mains element on the space heater is designed for supplementary heating. It is not recommended to run along side the gas for prolonged periods of time.

Technical Data

Power supply:	230 V ~, 50 Hz
Power consumption at power setting:	500 W: 2.2 A 1000 W: 4.5 A 2000 W: 8.5 A
Weight:	approx 2kg

Butterfly outlets

The butterfly plate may be opened or closed to control the quantity of air and may also be twisted around to control direction.

For uniform distribution, outlets nearest the heater should be closed more than those further away.



Blown air







The air ducting outlets are generally of the butterfly type and may be opened or closed by adjusting the butterfly valves. Twisting the disc in its housing directs the flow in the direction required.

One outlet on each leg of the air ducting layout must be kept open at all times.

ALDE COMPACT 3010 QUICK START GUIDE

Use the Left < and Right > arrow keys to move across the symbols. Highlight the required symbol so that it flashes. You can then adjust the function.

Use the +/-On and -/Off keys to adjust settings and turn functions On and Off. Turn off 'Space Heater'switch on PSU.

- On** With 'On' displayed the boiler is in standby mode and ready to be given commands.
- Off** With 'Off' displayed the boiler is shutdown.
-  Select your desired room temperature.
-  30 min hot water booster, with this function 'On' the circulation pump for the heating is turned off.
-  Select 'On' to operate the boiler LPG.
-  Select 1kW or 2kW to operate the boiler on 230V Electric.
-  Indicates that the circulation pump is operating for central heating.
-  Indicates that 230V is supplied to the boiler.

PRE-START CHECKS

- Ensure the system is filled with Glycol before starting the boiler, check the expansion tank level. The fluid should be 10mm above the minimum mark when cold.
- Ensure adequate LPG Propane, 230V and 12V supplies are connected and turned on. The control panel should be active and display the 230V connection symbol.
- Turn the boiler 'On' using the control panel, then scroll across and raise the desired room temperature to +30°C. The circulation pump symbol should appear. Visually check in the expansion tank that the pump is operating.

- Scroll across and turn on the 2kW electric heater using the panel. Wait for 10 minutes and check that the upper flow pipe on the boiler is getting hot. The bottom return pipe may also be warm.
- Scroll back and turn on the gas burner using the control panel. You might not be able to hear it start, so visually check the flue outside to confirm the boiler is operating. Wait for 10 minutes and check the lower return pipe on the boiler. It should now be hot and the boiler fully operational.



ALDE COMPACT 3010

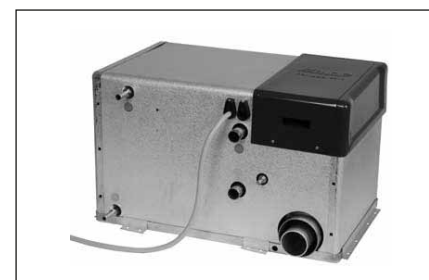

Please read these instructions carefully before using the boiler.

These instructions are approved for The Alde Compact 3010 boiler fitted in caravans, motor caravans and buildings in accordance with CE no. EMC e5 02 0138, 845 BP-0003.

Installation and repairs may only be carried out by a professional. National regulations must be adhered to.

BOILER DESIGN

The boiler consists of three eccentrically- fitted cylinders (heat exchanger, water jacket for the heating system and, outermost, water jacket for hot water). The two outer pipes, and their ends and connections, are made of stainless steel, while the heat exchanger is made of aluminium.

The heat exchanger is divided into two semi-circles. The burner is located in the upper half, being the combustion chamber, and the combustion gases are expelled through the lower half. The burner unit is fitted on the end of the heat exchanger. It consists of a combustion fan, burner, solenoid valve and intake/exhaust connections. Two heating cartridges are fitted to the water jacket of the heating system. Maximum output is 2 or 3 kW, depending on model.

DESCRIPTION OF FUNCTIONS

Using LPG

When LPG operation is selected on the control panel, the combustion fan starts. When the fan speed is correct, it signals the circuit board that the boiler can be lit. The circuit board sends ignition sparks to the spark plug at the same time as it sends electricity to the solenoid valve, which opens to allow gas in. The burner ignites, and a sensor transmits a signal back to the circuit board that the boiler is lit, and the ignition spark stops. The burner keeps burning until the boiler thermostat or the room thermostat reaches the set temperature reading.

Should the boiler go out for any reason, the sensor is activated and a new attempt is made to start the boiler (in about 10 seconds).

Using the heating cartridge

Electrical operation is selected on the control panel, the 12-volt relays on the circuit board trip, allowing the 230 volt supply to reach the electrical elements.

The heating cartridge is controlled in the same way as the gas boiler.

ALDE HEATING

Warm water

When only warm water is required, for example during the summer, no settings need to be made, the boiler will look after this function automatically.

The pump will only start when the temperature in the vehicle is lower than the set temperature (see item 4, Control Panel). If the vehicle temperature is higher, the pump will not start.

IMPORTANT INFORMATION

- The boiler must not be started if there is no glycol in the system.
- The LPG boiler and heating cartridge may be operated in parallel.
- The heating system may be heated up without the warm water heater being filled with fresh water.
- Always switch off the main isolator for the boiler when the vehicle is not being used.
- Always drain the warm water heater of fresh water if there is a risk of frost.
- The LPG boiler must not be operated when refuelling the vehicle.
- When washing the vehicle, take care not to get water in the venting.

The Domestic hot water heater

The boiler is fitted with a built-in warm water heater with a volume of approx. 8.5-litres fresh water. The warm water heater can produce around 12 litres of 40°C water per half-hour (at a cold water temperature of 10°C). If the heating cartridges are used instead of gas for heating the boiler, the capacity is slightly reduced.

Always rinse out the heater before it is used, particularly if it has not been in operation for some time.

NB! The hot water is not intended for drinking or cooking.

When the heater is in continuous use, it should be emptied approx. once a month, to ensure that a new air cushion is formed in the heater.

The air cushion is essential for absorbing pressure surges in the heater.

NB! The warm water heater should always be drained of fresh water when there is a risk of frost and when the caravan is not in use.

The warranty does not cover frost damage.

Draining the heater using the combined safety/drain valve:

1. Switch off the freshwater pump
2. Open all water taps.
3. Then open the safety/drain valve by raising the yellow lever (M) to a vertical position.
4. The heater will now drain directly below the vehicle through the safety/drain valve hose. Check that all the water is emptied out (about 7-10 litres). Leave the valve in the open position until the next time the heater is used.

NB! Check that the automatic check valve (N) is open and is allowing air to enter the heater when it is being drained, and that the hose (O) is not blocked.

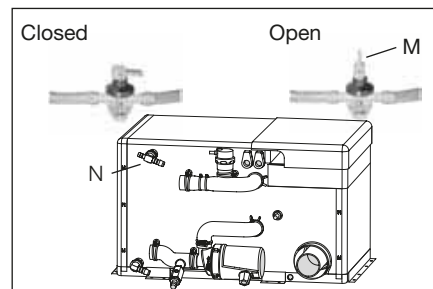
**THE HEATING CARTRIDGES**

All Compact 3010s are fitted with two 230V heating cartridges with a maximum output of either 2100 or 3150W. Select the heating cartridge output on the control panel.

Always check that the input supply of the vehicle has the correct amperage in relation to the selected output.

Note these ratings are for the boiler only.

1050W requires a 6 amp fuse/supply.
2100W requires a 10 amp fuse/supply.
3150W requires a 16 amp fuse/supply.

THE CIRCULATION PUMP

A circulation pump is required to circulate the heated glycol fluid. A 12V circulation pump is fitted in the expansion tank.

An optional 230V circulation pump can be fitted on the boiler. Selection of circulation pump is made with a switch on the control panel. The room thermostat on the control panel controls the circulation pump, i.e. switches it on or off according to the amount of heat required.

SYSTEM TEMPERATURE

The boiler is set to a system temperature of 80°C, i.e. the temperature of the glycol fluid as it circulates in the heating system.

AIR CIRCULATION

In order to achieve the best possible result from the principle of convected heat, it is important to allow air to circulate freely under bunks, and behind backrests and wall-mounted cabinets.

If the vehicle has a fitted carpet, ensure that the carpet does not obstruct the air supply to the radiators.

It is just as important that cushions or blankets do not interrupt the flow of air behind backrests and wall cabinets.

Note: During the first weeks of ownership customers may notice a drop in the glycol level and/or blocked radiators. This is normal as the system settles.

MAINTAINING THE HEATING SYSTEM**WINTER CAMPING**

While camping during the winter, ensure that the flue is kept clear of snow and ice, since the inlet air to the LPG boiler enters through the flue. Do not start the LPG boiler until the flue is completely free of snow. A flue extension (part no. 3000 320) for fitting on the roof is recommended for winter camping.

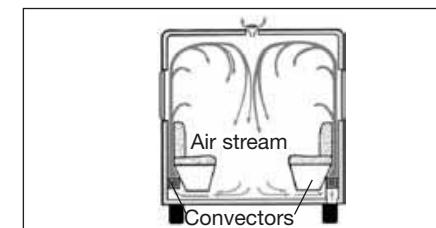
**THE HEATING SYSTEM**

Regularly check the heating system's fluid level in the expansion tank. The level should be about 1cm above the minimum indicator in a cold tank. The heating system should be filled with a mixture of water and glycol.

For preference, use high quality ready mixed glycol (with inhibitor) intended for use in aluminium heating systems.

If using concentrated glycol, the mixture should consist of 50% water and 50% glycol. If the heating system will be exposed to temperatures below -25°C, the glycol content must be increased, but not to more than 50%. Any vessels used for the liquid must be spotlessly clean, and the pipes in the heating system must be free of contamination. This will prevent the growth of bacteria in the system.

The glycol mixture should be changed every second year, since its ability to protect against

ALDE HEATING

corrosion, for example, will deteriorate. The glycol content should be checked before topping up with new liquid. This will ensure that the concentration of glycol in the mixture is not too high.

If the fluid level in the expansion tank falls for reasons other than evaporation, please check all joints, drain cocks and bleeder screws to ensure that they are not leaking. If the glycol-water mixture leaks out, rinse with water and wipe up.

Never allow the heating system to stand empty of glycol.

FILLING THE SYSTEM WITH GLYCOL FLUID

NB! Any vessels used to carry the fluid must be spotlessly clean and the pipes in the system must be free of contamination. This will prevent the growth of bacteria in the system.

The system is filled through the expansion tank, either manually or using the Alde filling pump which both tops up and bleeds the system. For manual filling, unfasten the circulation pump nut (R) and lift the pump (S) out of the tank. Slowly pour the glycol mixture into the tank. Bleed the system.

Top up with more liquid if the level has fallen after bleeding. Bleed a newly filled system regularly during the first days the heating system is in operation.

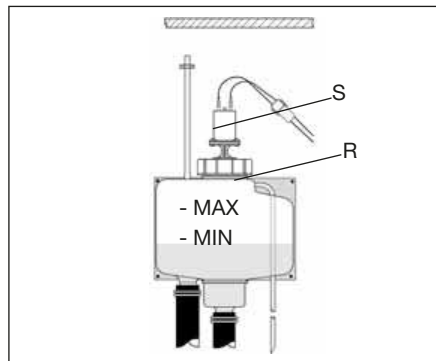

BLEEDING THE SYSTEM

Depending on how the pipes have been fitted, air pockets may form when the system is filled with glycol fluid.

A sign that there is air trapped in the system is that the heat released into the pipes only extends a metre or so from the boiler even though the circulation pump is operating.

In newly-filled systems, small air bubbles can form in the expansion tank, creating a murmuring sound. If the circulation pump is stopped for a few seconds, the bubbles will disappear.

Bleeding:

If a bleeder screw is fitted to the outgoing pipe, open this bleeder screw and leave it open until it starts to discharge water.

If the boiler is fitted with an automatic bleeder, there is no need to bleed it manually. Start the LPG boiler. The circulation pump should be switched off.

Open the remaining bleeder screws in the system (please refer to the instruction manual of the vehicle for their locations). Leave the bleeder screws open until they start discharging fluid, and then close them. Start the circulation pump and let it run for a while. Check that the pipes and radiators around the vehicle are heating up.

If there are still issues, try the following:

Single-axe caravan:

Stop the circulation pump. Lower the front of the caravan as far as possible. Leave it in this position for a few minutes to allow the air to travel upwards in the system. Open the bleeder screw at the highest point. Leave it open until it discharges glycol fluid. Raise the front of the caravan as far as possible and repeat the procedure in this position.

Then position the caravan horizontally and start the circulation pump. Check that the pipes and radiators around the vehicle are heating up.

Twin-axe caravan:

The easiest way to bleed the heating system is to place the vehicle on a sloping surface or to raise one end of the vehicle using a jack. Bleed the system as described above.

FAULT FINDING

The boiler does not start

1. No LPG? Incorrect type for conditions?
2. Is the main tap fully open?
3. If the boiler has not been operated for some time, or if the gas cylinder has been changed, it may take longer than normal to light the boiler.
4. Check that the boiler is connected to the electricity supply (> 11V).
5. Check that the fuse (T) for the boiler is intact.
6. Check whether the electric connections on the boiler are securely in position.

If none of the above helps, contact a service workshop.

The heating cartridge is not working

1. Check that there is an electricity supply (230V ~) to the heating cartridge.
2. Check that the relays fitted to the boiler come on (a slight click can be heard from the relays when the heating cartridge is switched on at the control panel).

If none of the above helps, contact a service workshop.

CONTROL PANEL – FUNCTIONS AND SYMBOLS

(Applies to control panels with program version 38 (06-17) or later, see item 17)

0. The standby and on-position of the control panel

In standby, the functions which are activated in the boiler are shown, and there is no background lighting in the display. The control panel automatically goes to standby from the on position after two minutes if no buttons are pushed or if you step to standby (left of On/Off) with the arrow keys.

Start the on position by pressing any button. The background lighting comes on (blue light) and a function that can be set flashes. Select a function that can be set with the arrow keys. The settings are automatically saved.

1. The control panel is on standby and the heater is switched off.

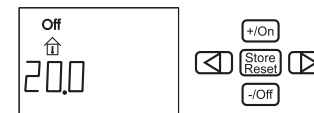

2. The control panel is on standby and the heater is operating.

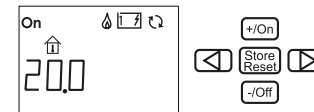

ALDE HEATING

1. RESETTING THE SYSTEM

1. Press the Store/Reset button for 10 seconds. The control panel is reset to the factory setting.

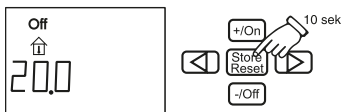

2. The main breaker to the control panel is in the "Off" position, Gas is on, Electricity at 1kW and 22°C.

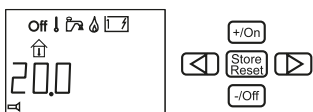

The pump is in automatic position.
The lower menu row is not lit up.

2. START THE HEATER

Start the heating in the caravan with the settings last used.

If you break the power to the heater, the settings which were last used will automatically be used when the power comes back on.

1. Press the button with the arrow until "Off" (main breaker) in the display flashes.

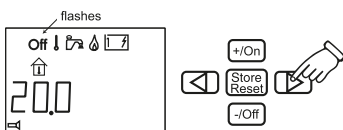

2. Press the +/On button. "On" (main breaker) in the display flashes.

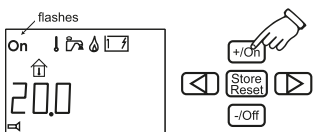

3. The settings are ready. "On" (main breaker) is shown in the display when the panel returns to standby.

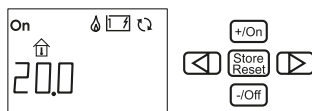

3. SWITCH OFF THE HEATER

1. Press the button with the arrow until "On" (main breaker) in the display flashes.

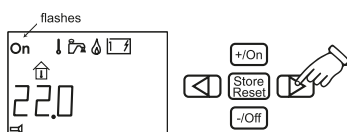

2. Press the -/Off button. "Off" (main breaker) in the display flashes.

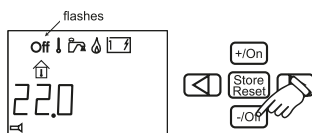

3. The settings are ready. "Off" (main breaker) is shown in the display when the panel returns to standby.

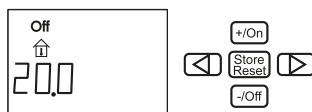

4. SET THE TEMPERATURE YOU WANT IN THE VEHICLE



The temperature of the vehicle can be set from +5°C to +30°C at intervals of 0.5°C.

1. Press the button with the arrow until the symbol for selecting temperature flashes.

The temperature shown is the temperature which is set at present (in this case 22.0°C).

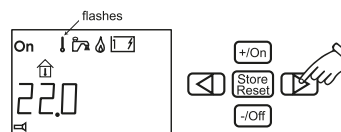

2. Increase the temperature by pressing the +/On button. Lower the temperature by pressing the -/Off button. The diagram shows that we have set the temperature at 25.0°C.

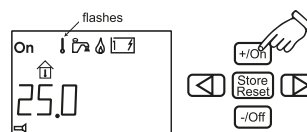

3. The settings are complete and the boiler is working at the set temperature.

5. WARM WATER



If you need more warm water you can increase the quantity temporarily for 30 minutes by increasing the water temperature from 50°C to 65°C.

When 30 minutes have elapsed, the water temperature returns to 50°C and the symbol goes out. When you have selected more warm water, the circulation pump stops.

1. Press the button with the arrow until the symbol for selecting warm water flashes. The "OFF" text is shown next to the temperature on the display.

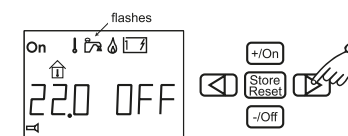

2. Switch the warm water on by pressing the +/ON button. The "ON" text is shown next to the temperature on the display.

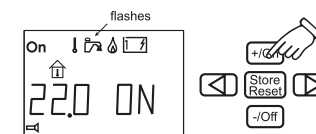

3. The warm water symbol is displayed when the panel returns to standby.

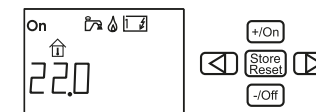

ALDE HEATING

If you want you can switch off more warm water before 30 minutes have elapsed.

1. Press the button with the arrow until the warm water symbol flashes. The "ON" text is shown next to the temperature on the display.

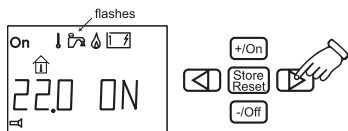

2. Switch off the warm water by pressing the -/Off button. The "OFF" text is shown next to the temperature on the display.

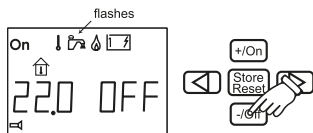

3. The warm water symbol goes out when the panel returns to standby.

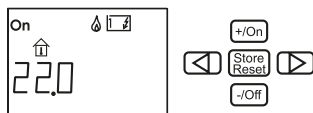

6. HEATING WITH GAS



Do as follows to activate heating with gas.

1. Press the button with the arrow until the gas heating symbol flashes. The "OFF" text is shown next to the temperature on the display.

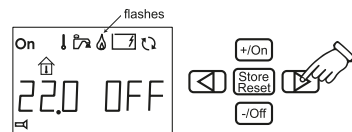

2. Select gas heating by pressing the +/On button. The "ON" text is shown next to the temperature on the display.

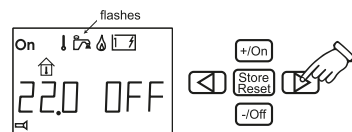

3. The gas heating symbol is displayed when the panel returns to standby.

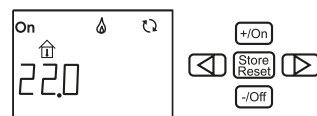

Do as follows to switch off the gas heating.

1. Press the button with the arrow until the gas heating symbol flashes. The "ON" text is shown next to the temperature on the display.

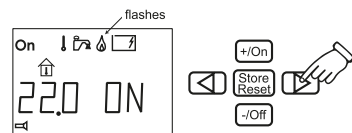

2. Switch off the gas heating by pressing the -/Off button. The "OFF" text is shown next to the temperature on the display.

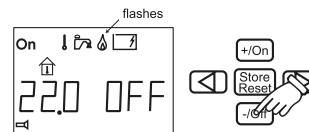

3. The gas heating symbol goes out when the panel returns to standby.

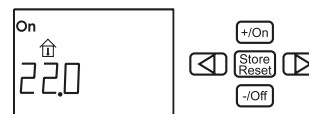

7. HEATING WITH ELECTRICITY



To activate heating with electricity. The greater the power the more rapid the heating will be.

1. Press the button with the arrow until the electrical heating symbol flashes. The "OFF" text is shown next to the temperature on the display.

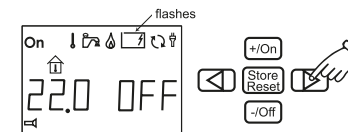

2. Select power (1kW, 2kW or 3kW) with the +/On or -/Off buttons. The diagram shows that 3kW power has been selected (some boilers are only equipped with 1-2kW).

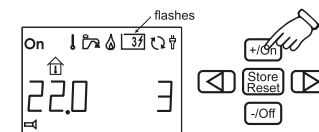

3. The electrical heating symbol is shown when the panel returns to standby.

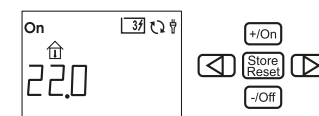

Do as follows to switch off heating with electricity.

1. Press the button with the arrow until the electrical heating symbol flashes.

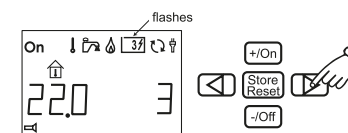

ALDE HEATING

- Switch off the electrical heating by pressing the -/Off button until all power steps have gone out. The "OFF" text is shown next to the temperature on the display.

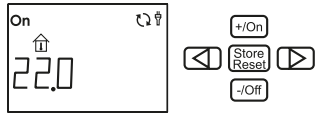

- The electrical heating symbol goes out when the panel returns to standby.

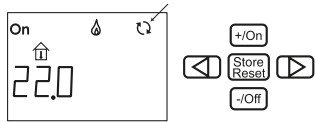

8. CIRCULATION PUMP



This symbol is displayed when the circulation pump is operating (12V-pump or 230V-pump).

When heating is required in the vehicle, the pump starts automatically.

The boiler selects the 230V pump if one is installed in the system. When the 230V is disconnected from the vehicle the 12V pump is automatically selected. The symbol will light up even if the pump is defective.

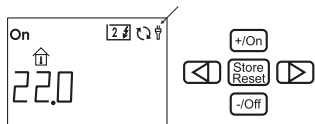

9. 230V CONNECTION



This symbol lights up when 230V is connected to the vehicle.

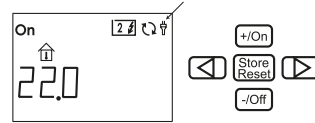

10. TEMPERATURE



This symbol shows the indoor temperature in the caravan in intervals of 0.5°C.



This symbol shows the temperature outside the caravan in intervals of 1°C. To use this function an outdoor temperature sensor must be installed.

11. WORKING WITH THE LOWER MENU ROW



The lower menu row can be used for such things as setting the clock, external start, night temperature, automatic start of the heater. To use the lower menu row you must activate it by doing as follows:

- Press the button with the arrow until the symbol for the lower menu row flashes.

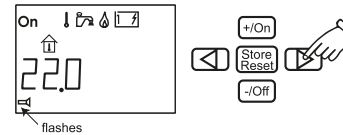

- Light up the menu row by pressing the +/On button. The lower row with symbols lights up.

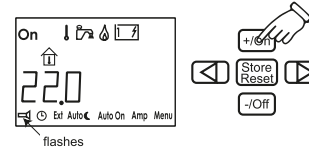

- To switch off the lower menu row, press the -/Off button when the symbol flashes. Activated functions will be displayed even if the lower menu row is switched off.

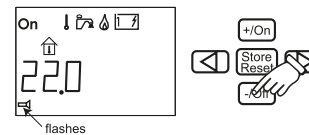

12. CLOCK



To set the clock, first light up the lower row of functions (see item 11).

- Press the button with the arrow until the clock symbol flashes.

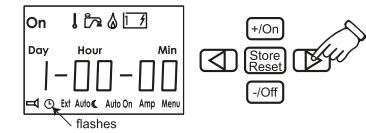

- Press the +/On button. Day flashes. Use +/On or -/Off to set the weekday.

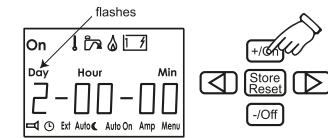

- Step forward with the arrow key until the time is displayed. Hour flashes. Use +/On or -/Off to set the full hour.

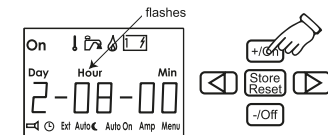

- Then step forward with the arrow key until the minutes are displayed. Min flashes. Use +/On and -/Off to set the minutes.

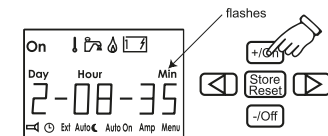

ALDE HEATING

- Press Store and the time you have set is stored. The example shows Tuesday, 08.35.

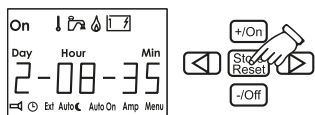

If the power to the panel is broken and the battery backup is not connected, the clock must be set again.

Weekday: 1-7

1=Monday

7= Sunday

Hours: 0-23

Minutes: 0-59

13. EXTERNAL START EXT

This function is used if you wish to start the heater in the caravan from outside. To use this function it is necessary to have an installation for external start (see vehicle manual). To activate external start, first light up the lower menu row of functions (see item 11).

- Press the button with the arrow until the "Ext" symbol flashes. The "OFF" text is shown next to the temperature in the display.

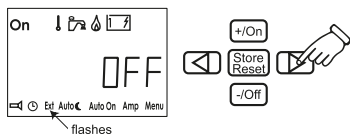

- Press the +/-On button. The "ON" text is shown next to the temperature in the display.

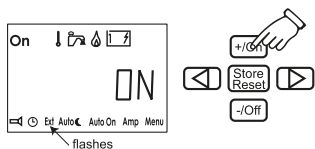

- Press the button with the arrow until the On symbol (main breaker) flashes. Press -/Off.

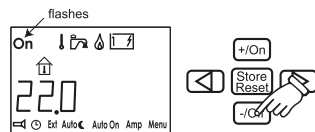

- Off and Ext are shown in the display when the panel returns to standby. External start is activated.



When external start is activated the heater will start with the latest settings and "ON" (main breaker) comes on. If 12V is not connected to the heater, the display will not light up until 12V is connected. The external start function is still activated.

To switch off external start, go to the "Ext" symbol in the on position and press the -/Off button.

14. AUTOMATIC TEMPERATURE CHANGE Auto

This function is used when you wish to set automatic temperature change, for example, during the night.

In order to activate automatic temperature change, first light up the lower row of functions (see item 11).

- Press the button with the arrow until the symbol for automatic temperature change flashes. The temperature and the "OFF" text are shown on the display.

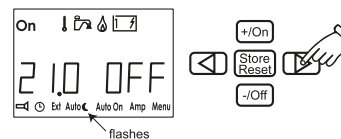

- Press the +/-On button. Set flashes and the OFF text is shown in the display. Press +/-On to activate the function. "ON" is shown in the display.

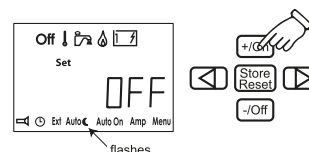

- Press the left arrow key. The required temperature is displayed. Then adjust the temperature by pressing the +/-On or -/Off button.

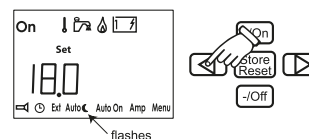

- Then press Store and the start time is displayed. Adjust the start time (the same procedure as in 12) and press the "Store" button.

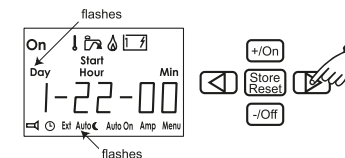

- Now adjust the stop time and press "Store" again. The text field shows the required temperature and ON.

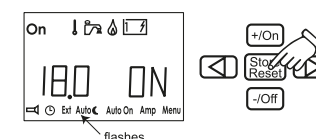

- If you want the temperature change to be repeated daily, select day 0. Auto is shown in the display when the panel returns to standby.

15. STARTING THE HEATER AUTOMATICALLY AutoOn

This function is used if you want the heater to start automatically at a later time. The heater works for 24 hours and then stops.

Automatic start is repeated the following week as long as the function is activated.

To activate the function you must first light up the lower row of functions (see item 11).

The function controls the panel's main breaker.

- Press the button with the arrow until the AutoOn symbol flashes. "OFF" is shown in the display. To activate AutoOn, press the +/- On button or the -/Off button to close the function.

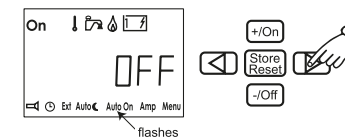

ALDE HEATING

- The start time will be displayed. Set the time in accordance with item 12 and press "Store" to store the settings. "OFF" is shown in the display.

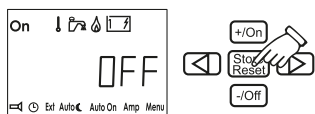

- Press the +/-On button. On is shown in the display and AutoOn flashes. Set the panel's main breaker to OFF.

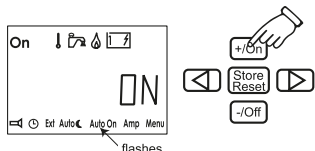

When you get to the vehicle and AutoOn is activated, de-activate AutoOn so that the heater does not stop after 24 hours (the boiler cannot be switched off when AutoOn is activated).

You can then step back with the left-hand button in the settings and press Store in all positions.

16. LOAD MONITOR AMP

This function is used if you do not want the 230V fuses to become overloaded. If the vehicle's total current consumption exceeds the set value, the boiler's electrical power will be automatically reduced. On account of voltage variations and tolerances, one can select various control levels (for example, for 6A fuse, one can choose either 5,6,7 Amp setting).

If the fuse does not hold, select a lower set value. The function is disconnected in the factory setting. To activate the function, you must first light up the lower row of functions (see item 11).

- Press the button with the arrow until the Amp symbol flashes. "OFF" is shown in the display.

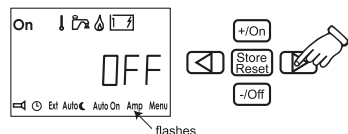

- Press the -/Off button to activate and set the function. The following values can be set with +/-On or -/Off buttons, 5,6,7,9,10,11,15,16,17.

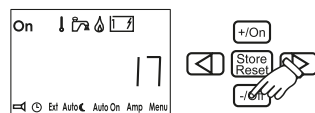

- Amp is shown in the display when the panel returns to standby.

17. MENU Menu

In the "Menu" setting one can activate a number of functions. To activate the function you must first light up the lower row of functions (see item 11). To step between the various functions, use the arrow keys.

OFFSET (Temperature adjustment)

With this function you can calibrate the temperature on the panel if you notice that the temperature (the stabilised room temperature) does not correspond with the temperature shown on the panel.

- Press the button with the arrow until the Menu symbol flashes. Press +/-On.
- When OF is displayed, adjust the temperature displacement with +/-On or -/Off (+/-5°C in intervals of 0.5°C).

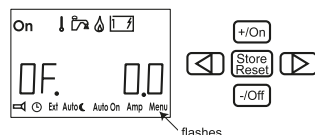

- Press Store to leave the OFFSET function.

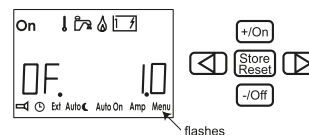

PUMP 12V/PUMP AU.

The 12V pump is used in the PU 12 setting even if 230V is connected. In the PU AU position, the 230V pump works, and when 230V is disconnected, the 12V pump starts. The PU AU function is activated in the factory setting.

- Press the button with the arrow until the Menu symbol flashes. Press +/-On.
- When OF is displayed, step with the arrow key until PU AU is displayed. Press +/-On and PU 12 is displayed.

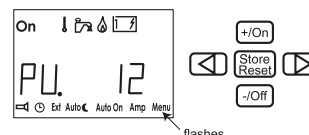

- Press -/Off and PU AU is displayed. Press Store to leave the pump function.

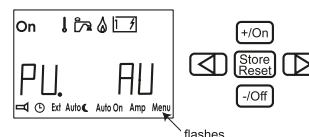

SERVICE

With this function one can see what values* from the heater are displayed. The values are updated once per second.

- Press the button with the arrow until the Menu symbol flashes. Press +/-On.
- When OF is displayed, step with the arrow key until SE is displayed. Press +/-On to see the various values (-/Off can also be used).

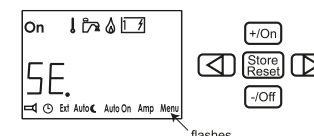

- To leave Service, press Store.

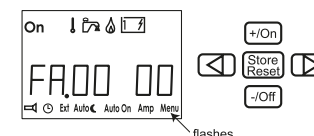

* The values shown during service are:

FA (revolutions): The speed of the fan divided by 2.

SH (temp): Warm water temperature.

HE (temp): Operating temperature.

OH: If the overheating protection has been tripped On or alternatively Off.

HS (X): Software version in the heater.

PS (X): Software version on the panel.

I: Amp. Guideline value shown in steps of 0.5 A.

WI: Window breaker on-off.

ES: External start on-off.

10-RS: Heater information, only for ALDE.

ALDE HEATING

BUTTON SOUND

With this function you can connect or disconnect the button sound to the buttons. The button sound is disconnected in the factory setting.

1. Press the button with the arrow until the Menu symbol flashes. Press +On.
2. When OF is displayed, step with the arrow key until Sn is displayed. Press +/On and the button sound is connected.

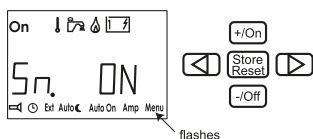

3. Press -/Off to disconnect the button sound. Then press Store to leave the button sound function.

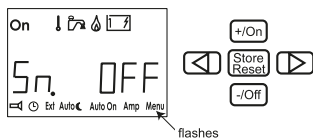

CONSTANT PUMP OPERATION

With this function, selected pump is in constant operation. The function is disconnected in the factory setting. This function limits the hot water supply, particularly when there is little need of heat.

1. Press the button with the arrow until the Menu symbol flashes. Press +On.
2. When OF is displayed, step with the arrow key until PE is displayed. Press +/On and constant pump operation is connected.

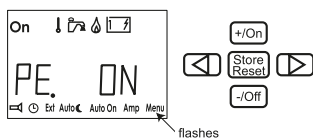

3. Press -/Off to disconnect constant pump operation. Then press Store to leave the pump operation function.

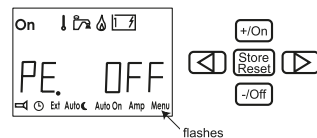

AUTOMATIC TEMP. INCREASE

At 02.00 hours (night time) the boiler starts and works in accordance with Warm water (item 5) if the clock is set. The reason for this is to reduce the risk of legionella.

The function is disconnected in the factory setting.

1. Press the button with the arrow until the Menu symbol flashes. Press +On.
2. When OF is displayed, step with the arrow key until LE is displayed. Press +/On and legionella is connected.

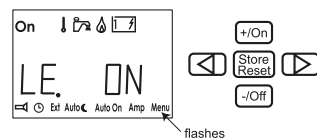

3. Press -/Off to disconnect legionella. Then press Store to leave the legionella function.

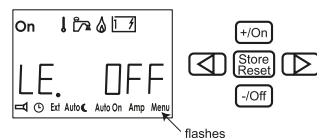

18. FAULT MESSAGES

When a fault occurs in the system the reason is shown in the display.

LOW BAT: If the vehicle has a battery voltage of less than 10.5V, the heater stops. The heater is automatically reset when the voltage comes up to 11V.

FAN: Faulty fan speed. Automatic resetting after 5 minutes.

GAS OUT: Gas finished. Resetting by switching off and restarting the boiler in accordance with item 1.

OHEAT 1: Overheating protection tripped. To re-set, disconnect 12V from the boiler and connect again.

OHEAT 2: Thermostat tripped. To re-set, disconnect 12V from the boiler and connect again.

WINDO: Window open, the boiler stops for gas. Gas operation in the boiler starts when the window is closed. Electrical operation functions. Check the vehicle instructions to see whether this function is installed.

SERIAL: There is a connection fault between boiler and panel. Normally, this is a mechanical fault in the connection between the heater and panel. To re-set, break the main current and then start again.

19. EMERGENCY START

- Disconnect 12V and the cable to the panel on the heater.
- Connect a cable between 2 and 9 in the contact device (on the heater).
- Connect 12V to the heater.

Now the heater starts with gas and 1kW. (Regulation of room temperature does not function, constant pump operation)

TECHNICAL DATA

Measurements/Weights

Boiler height:	310mm
Boiler depth:	340mm
Boiler width:	510mm
Weight:	14kg (without fluid)

Gas	Propane	Butane
Output 1:	3.3kW	3.8kW
Consumption	245g/h	275g/h
Output 2:	5.5kW	6.4kW
Consumption:	405g/h	460g/h
Pressure:	I3+ 28-30/37 mbar I3B/P 30 mbar	

Volume/Pressure/Temp

Liquid volume radiator water:	3.5 litre
Liquid volume warm water:	8.4 litre
Max pressure radiator water:	0.05MPa (0.5 bar)
Max pressure warm water:	0.3MPa (3.0 bar)
System temperature:	max 85°C

230V ~

Output element:	1 x 1050W
Output element (2 or 3kW):	1 x 2100W

12V DC

Current consumption:	1 amp (max)
Fuse:	3.15 amp+ / 3.15amp-

THETFORD ABSORPTION REFRIGERATORS

This user's information is for Thetford absorption refrigerators. It explains how to use your refrigerator correctly and safely. Read the manual carefully before using the refrigerator for the first time to obtain a quick overview of how to operate and use the refrigerator.

Thetford absorption refrigerators are specially designed to store fresh and frozen food and make ice cubes in caravans and campers. The control panel allows you to select the preferred energy source and cooling level. Different energy sources allow you to use your refrigerator under different conditions.

Thetford absorption refrigerators belong to category C11: gas appliances that must be installed so that the combustion area is isolated from the living space.

To find out more about how your absorption refrigerator works, visit the website at www.thetford-europe.com.

Precautions and safety instructions

Alerts

The following alerts are used in this user's manual:

- Warning!** "Warning" alerts the user to the danger of damage to the product or to the user if the user fails to carry out the described procedures carefully.
Non-observance of the procedures may result in serious injury to the user or damage to the product.
- Caution!** "Caution" alerts the user to the possibility of damage to the product if the user fails to carry out the described procedures carefully.
- Important!** "Important" denotes supplementary information for the user and alerts the user to potential problems.

Warnings

- This refrigerator must be installed according to the manufacturer's instructions and in compliance with local and national regulations.
- Read this manual carefully before you start to use your refrigerator.
- Always consult the warnings before you perform any maintenance or gas checks.

Repairs/maintenance

- Never open or damage the cooling system. The cooling system is pressurised and contains substances harmful to health.
- Never attempt to repair gas, extractor or electrical parts yourself. They must be repaired by a qualified service engineer. Contact the Customer Service department of Thetford for a list of qualified parties.
- Always switch off the refrigerator before you perform any kind of maintenance or cleaning.

Use

- Never cover the ventilation grills in the walls of a caravan. Good ventilation is essential for the correct working of the absorber system.
- Water in the ventilation grating can result in damage to the refrigerator. Therefore, we advise that you put the winter cover over the ventilation gratings prior to washing your vehicle.
- Never expose the refrigerator to rain.
- Never operate the refrigerator by gas while driving. If a road accident results in fire, there is a risk of explosion.

What to do if...

- You smell gas:
 - close the valve of the gas bottle;
 - extinguish any naked flames;
 - do not switch on any electrical devices or lighting;
 - open the windows and leave the room;
 - contact the Customer Service department of Thetford.
- You suspect a leak in the cooling system:
 - switch off the refrigerator;
 - extinguish any naked flames;
 - provide sufficient ventilation;
 - contact the Customer Service department of Thetford (0114 273 8157).

About your refrigerator

Your refrigerator has a cold space and a freezer compartment. After starting up the refrigerator, allow it to cool for at least eight hours before placing any food in it.

Cold space

The cooling fins are located on the inside of your refrigerator. The absorption system uses the cooling fins to withdraw heat from the refrigerator. Therefore, never place plastic or paper over the cooling fins. Air must be able to circulate freely through the refrigerator so that heat can be extracted.

Important! Do not cover the cooling fins at the back of the refrigerator with plastic or paper. The refrigerator cools optimally when air is allowed to move freely through the refrigerator.

- To limit frosting on the cooling fins:
 - always cover liquid foods before placing them in the refrigerator;
 - always let hot food cool before placing it in the refrigerator;
 - never keep the refrigerator open longer than necessary.

Fitting racks

Inside your refrigerator there are two or three storage racks. You can adjust the racks to a convenient height by means of a simple click system:

- click the plastic bracket to the right short side of the rack;
- turn the bracket into the horizontal position and insert the rack tipped in a sloping position into the refrigerator;
- place the short side without bracket into one of the grooves on the left wall of the refrigerator;
- place the short side with bracket in the corresponding groove on the right wall of the refrigerator;
- turn the bracket downwards to fix it into the groove.

To move a rack, turn the bracket upwards and remove the rack. Place the rack at the required height in the way described above.

THETFORD REFRIGERATORS

Securing products for driving

The fitting racks in your refrigerator have a system for you to secure products while driving. The system consists of a simple click-and-slide plastic strip. To secure products on the rack while driving, push the plastic strip as tightly as you can against the products on the rack. In the storage space on the inside of the refrigerator door, there are two unique Thetford bottle slides (see illustration). The slides prevent bottles from sliding around during driving. Push the slide against the products in the door or place the products between the bottle slide .



Freezer compartment

Important!

- The freezer compartment is unsuitable as a means of freezing food, the freezer will maintain the temperature of already frozen food
- Use only drinking water to make ice cubes.
- Do not place any other products in the freezer compartment when you are making ice cubes.
- Water freezes fastest with the thermostat at the highest setting.

Tip! Make ice cubes at night when your refrigerator has more spare capacity.

Door locking mechanism

The refrigerator door has an automatic locking mechanism. The door locks automatically when you press it shut firmly. This automatic locking mechanism also keeps the refrigerator door shut during driving. For some models an additional security device is fitted below the refrigerator. By pushing the locking bar over the pin when the door is closed, you can be sure that the door does not open during your journey.

If you are not going to use the refrigerator for a prolonged period of time, you can use the special storage latch of the door locking mechanism (see illustration) to prevent odours. Rotate the hook through 90 degrees and lock it in place using the strike plate.



Switching on the refrigerator

- It is recommended that you clean the inside of the refrigerator before you switch it on.
- Let the refrigerator cool for at least eight hours before you place food in it for the first time.

N112 PIEZO (MANUAL) IGNITION

Switching on the fridge – Manual Controls



A = Energy Source Selector Switch

B = Thermostat

C = Flame meter

**D = Manual ignition
(piezoelectric ignition)**

- The refrigerator can be powered by the mains (230V), direct current (12V) or liquid gas. Select the energy source that you want by means of the energy source selector switch (A). The switch has four settings:
 - mains supply (230V)
 - direct current (DC) (12V)
 - gas
 - switched off
 - The thermostat controls the refrigerator temperature when the refrigerator is powered from the mains (230 V) or gas. The refrigeration level is indicated by the dots (the bigger the dot, the colder the setting).
 - The flame meter shows whether the flame is alight. The flame is alight when the red needle of the meter moves into the green area.
 - Pressing the manual (piezoelectric) starter produces a spark that ignites the flame in the burner.
- Electrical operation**
- The refrigerator can be powered by electricity in two ways:
- DC (12V): Set the energy source selector switch (A) to  the refrigerator will now be powered by the battery of your car or camper.

Important! - Always use the gas connection or mains voltage to start up the refrigerator for the first time and to cool it. Powering from the battery of your vehicle is suitable only for maintaining the temperature of the refrigerator and its contents once it has been refrigerated.

- When powered by a vehicle battery (12 V) the refrigerator works without temperature control (i.e. constant operation).
- Mains voltage (230 V): set the power selector switch (A) to 
- Set the temperature by means of the thermostat, rotary switch (B). (The bigger the dot, the colder the setting).

Powering with gas

Warning! - Flammable material must be kept away from the refrigerator.

- For selection of gas type, see the information plate inside your refrigerator.
- For the pressure regulator model, see the information plate inside your refrigerator and the table at the end of this booklet.
- The type of gas container and its location must be in compliance with the most recent regulations. Ensure that the unit is installed in a location with good ventilation and make sure that the ventilation openings in the gas container storage location remain open.
- The changing of the gas container must be done outside in the open air and out of reach of any possible sources of ignition.
- You are strongly advised not to use gas to power the refrigerator while you are driving. If a road accident results in fire, there is a danger of explosion.
- You are strongly advised not to use gas to power the refrigerator in the vicinity of petrol stations.

THETFORD REFRIGERATORS

- 1 Open the valve of the gas bottle and the gas taps.
- 2 Set the Thermostat (B) to the highest level (the biggest dot).
- 3 Set the energy source selector switch (A) to 
- 4 Ignite the gas flame:

Manual ignition (illustration 5):

- Press the thermostat (B), and keep it depressed.
- Press the button for manual ignition (D) several times at intervals of between 1 and 2 seconds.
- Release the thermostat when the indicator of the flame meter enters the green area. If it does not enter the green area, repeat the previous step.

Warning! Never keep the thermostat depressed for longer than 30 seconds. If a flame does not appear, wait at least five minutes before trying again. If you fail to observe this rule, there may be an accumulation of gas creating the risk of fire or explosion.

- Set the desired refrigeration level by means of the thermostat (B). (The bigger the dot, the colder the setting)

Electrical ignition (illustration 6):



- Press the thermostat (B) and keep it depressed.
- Ignition takes place automatically. You will hear a ticking noise. If ignition was successful, the noise will stop and the flame meter will turn green. Release the thermostat.
- If the flame goes out, ignition will be repeated automatically.

- Set the desired refrigeration level by means of the thermostat (B). (The bigger the dot, the colder the setting)

Switching off the refrigerator

- Set the energy source selector switch (A) to 
- The refrigerator is now completely switched off.
- Use the special storage latch on the door locking mechanism to stop the door from closing. This prevents unpleasant odours and mould in the refrigerator.

Important! If you are not going to use the refrigerator for a prolonged period, close the valve of the gas bottle and the gas taps.

Electronic ignition

- EES (Electric Energy Selection): the 'Electric' version, where the preferred energy source has to be selected manually [no 'Auto' function possible]

Switching on the refrigerator – Electronic / LCD controls (control panel)

- It is recommended to clean the inside of the refrigerator before you switch it on.
- Let the refrigerator cool for at least eight hours before you place food in it for the first time.

Switching on the refrigerator

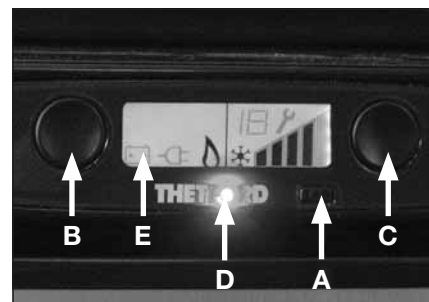

- A = Main switch (on/off)**
- B = Mode selection switch**
- C = Cooling level selection switch**
- D = Function LED**
- E = LCD display**

1. Open the valve of the gas bottle.
2. Open the taps of the gas supply.
3. Press main switch (A). The function LED will turn blue and all symbols on the LCD display will light up.
4. Use the mode selection switch to select the power supply that you want. The LCD display will show the option you have selected.

Note: 12V Power is required to use the refrigerator.

5. Set the desired refrigerating cooling level by means of the cooling level selection switch (C). The LCD display will show the cooling level setting you have selected.
- A. Use the main switch to switch the refrigerator on and off. The function LED will turn blue. The display LCD shows the most recent settings. After 10 seconds the LCD display's backlight will go out. The function LED remains blue.
- B. Press the mode selector switch and the LCD display backlight will show the setting for 10 seconds. Pressing the mode selector switch successive times takes you through the menu in the following sequence: Manual DC (12V), manual gas, manual mains voltage (230V).
- C. Use the cooling level selector switch to control the temperature of the refrigerator. When you press the cooling level selector switch, the LCD backlight will light up and show the currently set temperature. Every time you press the cooling level selector switch again, you set the refrigerator one position cooler. On reaching the coldest temperature, the system will start again at the warmest temperature setting. Ten seconds after release of the cooling level selector switch, the system will switch off the LCD backlight.

Note: It is advisable to cool the fridge using gas/230V electric before towing.

Selecting electrical power manually

Mains voltage (230V):

The LED warns you whenever insufficient voltage is available or if a fault occurs. If this happens, the LED will start flashing once per second and an error code is shown in the LCD display

When sufficient current is available again, or the fault has been resolved, the LED will emit a steady blue light again.

Direct current (12V):

The LED warns you whenever your vehicle's engine is not running, or if a fault occurs, or if insufficient voltage is available. If this happens, the LED will start flashing once per second and an error code is shown in the LCD display.

Once the engine is running, or the fault has been resolved, or sufficient voltage is available again, the LED will again emit a steady blue light.

Powering with gas

WARNING! - Flammable material must be kept away from the rear of the refrigerator.

- For selection of gas type, see the information plate inside your refrigerator.
- For the pressure regulator model, see the information plate inside your refrigerator and the table at the back of this booklet.
- The type of gas container and its location must be in compliance with the most recent regulations. Ensure that the unit is installed in a location with good ventilation and make sure that the ventilation openings in the gas container storage location remain open.
- The changing of the gas container must be done outside in the open air and out of reach of any possible sources of ignition.
- It is prohibited to use gas to power the refrigerator while you are driving.
- It is prohibited to use gas to power the refrigerator in the vicinity of petrol stations.

Selecting gas operation manually

If the flame cannot be lit within 30 seconds, the gas supply will stop and gas mode will be switched off. The LED start flashing every second and an error code is shown in the LCD display.

The gas mode can be reset only if the refrigerator is switched off. If you switch the refrigerator on again and the gas mode is still not working, the LED of the manual gas mode will flash to indicate that gas is unavailable and an error code is shown in the LCD display.

Important! It is prohibited to use gas to power the refrigerator while you are driving. If a road accident results in a fire, there is a danger of explosion. It is prohibited to use gas to power the refrigerator in the vicinity of petrol stations. If it takes longer than 15 minutes to refuel your vehicle, you should switch the refrigerator off using the main switch (A).

Switching off the refrigerator

- Push the main switch (A).
- The blue LED will go out.
- The refrigerator is now completely switched off.
- Use the special storage latch on the door locking mechanism to fixate the open door. This prevents unpleasant odours and mould in the refrigerator.

Frame heater

On the N175 fridge/freezer (twin door unit) a switch is located between the two doors. This switch operates a 12v heating element to eliminate any condensation on the fridge door seals from freezing.

Maintenance

Regular maintenance is necessary to ensure the correct functioning of your refrigerator.

Cleaning

Tip! A good time to clean your refrigerator is straight after you have defrosted it.

- Clean the refrigerator with a soft cloth and mild detergent.
- Dust the refrigerator with a soft, moistened cloth.
- Use a brush or soft cloth to remove once a year any dust from the condenser at the inside of the refrigerator.

Important! - Do not use soap or aggressive detergents that are abrasive or soda-based.

- The removable interior components of the refrigerator **are not dishwasher proof.**

Defrosting

Frost will gradually build up on the condenser of the refrigerator. You should defrost the refrigerator as soon as the frost layer is about 3 mm thick. Frost reduces the refrigerating capacity and life of your refrigerator.

- Remove the ice cube tray and all food.
- Switch off the refrigerator.
- Leave the refrigerator door open.
- Place dry towels in the refrigerator to absorb the water.
- Place trays containing hot water in the freezer compartment.
- After defrosting (when the freezer compartment and condenser are frost-free), remove the towels and the water trays and use a cloth to dry off the refrigerator.
- Switch the refrigerator on again in the way described in section 4.1 ('Igniting and starting your refrigerator').

Important! - Do not use force or sharp objects to remove frost.

- Do not try to accelerate defrosting by using (for example) a hair dryer.

Door locking mechanism

Frost will form in the refrigerator if the door is not closed properly. To determine whether the door closes properly, close the door with a piece of paper between the door and the refrigerator. Pull at the piece of paper. If you feel resistance, the refrigerator door closes properly. If you feel no resistance, the door does not close properly. Perform this test regularly on all four sides of the refrigerator door.

If you find that the door does not close properly, check whether the door locking mechanism keeps the door properly shut.

Winter operation

If you use the refrigerator when the outdoor temperature is below 8°C, install the Thetford vent winter/storage cover on the ventilation grills. The cover protects your refrigerator from excessively cold air. The winter cover is a refrigerator accessory obtainable from your caravan dealer.

Tip! It is advisable to use the winter/storage cover if you are not going to use the vehicle for a long period of time.



Ventilation grating with winter cover

Important; do not use the winter/storage cover in temperatures greater than 8°C as this can damage the cooling unit at the rear of the fridge. Remove the covers and re-fit when placing the vehicle back into storage.

Maintenance of gas equipment

A qualified service engineer must maintain and inspect gas and electrical equipment. It is advisable to have this maintenance work performed by a customer service centre. Contact the Customer Service department of Thetford for a list of qualified parties.

Important! European laws covering gas appliances and extractors prescribe observance of the following rules (which are the user's responsibility):

- appliances that run on liquid gas must be inspected before being used for the first time and every year thereafter.
- the gas burner must be cleaned at least once a year or more frequently if necessary.
- If a gas hose is used, it must be checked annually. This hose has a limited life and, thus, must be regularly replaced. Check the hose regularly for cracks, splits and ageing. If in doubt, replace the hose. Pay attention to the maximum life of the hose and replace it in time, as advised by the manufacturer or in conformance with local regulations.
- For replacement, a gas hose approved in accordance with the local regulations must be used. Position the hose so that it can rotate, is not kinked, and will allow
- Due to the limited life of the gas hose, it must be installed so that replacement is possible.

Maintenance checklist

This refrigerator will give you many years of trouble-free use if you simply run through the following checklist regularly:

- keep the refrigerator clean (see section 7.1 of the user instruction manual, 'Cleaning');
- defrost the refrigerator as often as is necessary (see section 7.2 of the user instruction manual, 'Defrosting');
- check the door closing mechanism regularly (see section 7.3 of the user instruction manual, 'Door locking mechanism');

- make sure that the ventilation grills are not blocked;
- Regularly clean the ventilation grills.

Vent screen

The vent has a vent screen to prevent bugs from entering the combustion area of the refrigerators. These vents need to be cleaned regularly to insure a good airflow. When the refrigerator performs poor because of external circumstances such as extreme ambient temperatures, the vents can be removed to improve the airflow and improve the cooling performance of the refrigerators.

Storage

If you do not expect to use your refrigerator for a lengthy period, carry out the following actions:

- Remove all food
- Switch off the refrigerator
- Clean the refrigerator as described in Section 7.1 'Cleaning'
- Shut off the gas tap to the refrigerator
- Leave the door of the refrigerator ajar using the special door closure hook (storage position)
- Place the winter protection on the ventilation grill.

Troubleshooting

If your refrigerator does not refrigerate properly or will not start, run through the following checklist. If this fails to solve the problem, please contact the Customer Service Department in your country (see the addresses at the back of the Thetford manual).

- Check whether you have followed the instructions in chapters 4, 5 or 6 of the user instruction manual ('Switching on the refrigerator').
- Check whether the refrigerator is on a level surface.
- Check whether the refrigerator can be used with an available energy source.

Possible cause	Action you can take
Problem: refrigerator will not work on gas	
a) Gas bottle is empty.	a) Replace the gas bottle.
b) Valve of the gas bottle or the blue shut-off valve is closed.	b) Open the valve of the gas bottle or shut-off valve(s).
Problem: refrigerator will not work on 12V DC	
a) 12V fuse is defective.	a) Fit a new fuse - Fuse 12 on the PSU.
b) Battery is empty.	b) Test the battery and charge it.
Problem: refrigerator will not refrigerate sufficiently	
a) Insufficient ventilation for the refrigerator.	a) Check whether the ventilation gratings are covered.
b) Thermostat set too low	b) Increase the setting of the thermostat
c) Too much ice on the condenser.	c) Check whether the refrigerator door shuts properly and defrost the refrigerator.
d) Too much hot food stored simultaneously.	d) Let the food cool off first.
e) Gas burner is dirty.	e) Have the gas burner cleaned.
f) Door does not shut properly.	f) Check the door closing mechanism.

Control panel diagnostics

Refrigerators with a LCD control panel have a special diagnostics area which displays an error code if there is a fault.

- **Fault 1:** AC heater current is measured to be 75% below nominal current.

Action: Contact your dealer or a Thetford Service Centre.

- **Fault 2:** DC heater current is measured to be 75% below nominal current.

Action: Contact your dealer or a Thetford Service Centre.

- **Fault 3:** AC heater is ON when it should be OFF.

Action: Contact your dealer or a Thetford Service Centre.

- **Fault 4:** DC heater is ON when it should be OFF.

Action: Contact your dealer or a Thetford Service Centre.

- **Fault 5:** Senses flame when gas should be OFF.

Action: Contact your dealer or a Thetford Service Centre.

- **Fault 6:** Senses gas output terminal ON when should be OFF.

Action: Contact your dealer or a Thetford Service Centre.

- **Fault 7:** Senses gas output terminal OFF when should be ON.

Action: Contact your dealer or a Thetford Service Centre.

- **Fault 8:** AC mains supply is 20% below nominal.

Action: Your controls are in manual AC mode, but there is no power available. Check if you plugged in the 230V connection, if so the voltage supply on the 230V connection is to low, contact the power supplier.

- **Fault 9:** Gas lockout because flame fails to ignite after 30 seconds.

Action: Your controls are in manual gas mode, but the flame fails to ignite. Check if your gas cylinder is empty or if one of the shut-off valves is closed. Select another energy source. Reset the fridge 3 or 4 times in gas-mode until flame ignites. Contact your dealer or a Thetford Service Centre if problem isn't resolved.

- **Fault 10:** No "engine running" signal is present and control is in Manual DC mode.

Action: Your controls are in manual DC mode and the engine of your vehicle is not running. The refrigerator can only cool on 12V when the engine of your vehicle is running. Start the engine or select a different energy mode.

- **Fault 11:** No energy source is available and control is in AUTO mode.

Action: Your controls are in AUTO mode, but no energy source is available. Start the engine, connect the 230V supply or open the gas supply and reset the refrigerator by turning it of and on again.

- **Fault 12:** Contact your dealer or a Thetford Service Centre.

- **Fault 13:** Thermistor fails; control automatically switches to Backup mode (BOS).

Action: Check if the connector above the fin on the inside of the cabinet is correctly plugged in. If so contact your dealer or a Thetford Service Centre.

- **Fault 14:** Display Board and Power board lost communication with each other.

Action: Contact your dealer or a Thetford Service Centre.

COOKER 3 BURNER + HOTPLATE OPERATION**Burner operation**

Fig. 1

IMPORTANT

- Although each burner will support pans from 10 to 22cm, care should be taken not to overload the appliance as performance may be reduced.
- The following pan sizes are the maximum we recommend:- Electric Hotplate:- Ø180mm
Auxiliary Burner:- Ø200mm
Semi-Rapid Burner:- 2x Ø200mm or 1x Ø220mm with 1x Ø180mm
- When using small pans the flames should not spread beyond the base of the pan as this will reduce the efficiency of the burner.
- Avoid old or misshapen pans as these may cause instability.
- The lid must be opened fully prior to using the hotplate burners.

Using the Hotplate Gas Burners

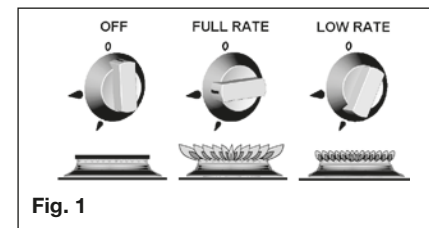
1. Ensure gas cylinder/supply is connected and turned on. In the event of a gas smell turn off at gas cylinder/mains and contact supplier.
2. Flame supervision: Each burner is controlled individually and is monitored by a thermocouple probe. In the event of the burner flames being accidentally extinguished, turn off the burner control and do not attempt to re-ignite the burner for at least one minute.

3. To light: Push in the control knob and turn to full rate – see Fig.1. Hold a lighted match or taper to the burner and push the control knob in and hold. It is necessary to hold the knob depressed after the burner has ignited for approximately 10 - 15 seconds, to allow the thermocouple probe to reach temperature, before releasing the knob. Should the flame go out when the knob is released, the procedure should be repeated holding the knob depressed for slightly longer.

4. For models fitted with Spark Ignition the procedure is similar except that the burner can be ignited by depressing the ignition button, which is located on the fascia. If the burner has not lit within 15 seconds the control knob should be released and the burner left for at least 1 minute before a further attempt to ignite the burner.
5. For simmering, turn the knob further anti-clockwise to the low rate position.
6. To turn off: Turn the control knob until the line on the control knob is aligned with the dot on the control panel. Always make sure the control knob is in the off position when you have finished using the hotplate burners.

OPERATION**Using the Electric Hotplate**

Ensure the electricity is switched on.

The hotplate control is numbered from 1 to 6. To turn it on, rotate the knob either clockwise or anti-clockwise to the required position. Position 1 is the coolest setting.

To turn the hotplate off, rotate the knob until the line or pointer on the knob lines up with the zero on the control panel.

The hotplate is a sealed construction and transfers heat through conduction. For maximum efficiency a correctly sized pan with a flat heavy gauge base should be used. Pan size should be the same or slightly larger (up to 1" / 2.5cm oversize).

Before using your hotplate for the first time, we recommend that you prime and then season it.

COOKER OPERATION

To prime the Hotplate

Switch on the hotplate for a short period, without a pan, to harden and burn off the coating.

Use a medium to high setting for 3 – 5 minutes. A non toxic smoke may occur during this process. Allow it to cool, then season.

To season the Hotplate

First heat the hotplate for 30 seconds on a medium setting, then switch off. Pour a minimal amount of unsalted vegetable oil onto a clean dry cloth or paper towel, and apply a thin coat of oil to the hotplate surface. Wipe off any excess oil, then heat the hotplate on a medium setting for 1 minute. Occasional seasoning will help to maintain the Hotplate's appearance.

WARNING

- Glass lids may shatter when heated. Turn off the hotplate and allow it to cool before closing the glass lid.
- Remove all spillage from the surface of the glass lid before opening.
- The glass lid has the tendency to snap shut towards the end of lowering.

This is caused by the travel lock action of the hinges as it is activated.

Make sure all fingers are removed from appliance when closing the lid.

IMPORTANT

- Depending on specification, your appliance may be fitted with a glass lid shut-off system, which cuts off the power to all hotplate burners (gas and electric) if the lid is closed.
- Ensure the glass lid is in the open and upright position before turning on the hotplate burners.
- Not all models are fitted with the shut-off system.

OPERATION**WARNING****On separate oven & Grill cookers**

- The grill area can get hot when the oven is in use, even if the grill is switched off.
- Care should be taken when removing pans from the grill, i.e. use of oven gloves, and by making use of the removal grill pan handle.

IMPORTANT

- The grill pan supplied is multi functional, for use in grill or oven.
- The handle design allows removal or insertion whilst the pan is in use.
- Always remove the handle when the pan is in use.
- The grill MUST only be used with the door open.

Using the Grill

1. Ensure gas cylinder/supply is connected and turned on. In the event of a gas smell turn off at gas cylinder/mains and contact supplier.
2. To light: Open door, push in the control knob and turn to full rate – see Fig 1 (page 129). Hold a lighted match or taper to the burner and push the control knob in and hold. The burner should ignite and the control knob should be held in for 10 -15 seconds before release.

If the burner goes out, repeat procedure holding control knob for slightly longer.

3. For models fitted with Spark Ignition the procedure is similar except that the burner can be ignited by depressing the ignition button, which is located on the fascia. Ignition must be carried out with the door open, and if the burner has not lit within 15 seconds the control knob should be released and the grill left for at least 1 minute before a further attempt to ignite the burner.
4. **Note:** the grill must only be used with the door open.

5. On first use of the grill, it should be heated for about 20 minutes to eliminate any residual factory lubricants that might impart unpleasant smells to the food being cooked. A non-toxic smoke may occur when using for the first time so open any windows and turn on mechanical ventilators to help remove the smoke.
6. Although the grill does heat up quickly, a few minutes preheat is recommended.
7. Flame Failure Device (FFD): the grill burner is fitted with a flame sensing probe, which will automatically cut off the gas supply in the event of the flame going out. In the event of the burner flames being accidentally extinguished, turn off the burner control and do not attempt to re-ignite the burner for at least one minute.
8. It is normal for the flames on this burner to develop yellow tips as it heats up.
9. A reversible grill pan trivet enables the correct grilling height to be achieved.

Fast Toasting	trivet in high position
Grilling Sausages	trivet in high position
Grilling Steak/Bacon	trivet in high position
Grilling Chops, etc	trivet in low position
Slow Grilling	trivet removed

10. To turn off: turn the control knob until the line on the control knob is aligned with the dot on the control panel. Always make sure the control knob is in the off position when you have finished grilling.

**OPERATION
IMPORTANT**

- The appliance is fitted with a cooling system. The cooling fans should automatically switch on a couple of minutes after the grill and/or oven is turned on, and will remain on even after the appliance has been switched off.
- The fans should automatically switch off a few minutes after the appliance has been switched off, when the front of the appliance has cooled sufficiently.
- A constant 12V supply is necessary at all times to ensure the cooling system operates correctly.

Using the Oven

1. Ensure gas cylinder/supply is connected and turned on. In the event of a gas smell turn off at gas cylinder/mains and contact supplier.
2. To light: Open door, push in the control knob and turn to full rate (240°C). Hold a lighted match or taper to the burner and push the control knob in and hold. The burner should ignite and the control knob should be held in for 10 -15 seconds before release. If the burner goes out, repeat procedure holding control knob for slightly longer.
3. For models fitted with Spark Ignition the procedure is similar except that the burner can be ignited by depressing the ignition button, which is located on the fascia. Ignition must be carried out with the door open, and if the burner has not lit within 15 seconds the control knob should be released and the oven left for at least 1 minute before a further attempt to ignite the burner.

COOKER OPERATION

4. Place the oven shelf in the required position and close the door. Set control knob to approximately 200°C and heat the oven for about 30 minutes to eliminate any residual factory lubricants that might impart unpleasant smells to the meals being cooked. A non-toxic smoke may occur when using for the first time so open any windows and turn on mechanical ventilators to help remove the smoke.
5. Although the oven does heat up quickly, it is recommended that a 10 minute preheat be allowed. The oven should be up to full temperature in about 15-20mins.
6. To turn off: turn the control knob until the line on the control knob is aligned with the dot on the control panel.
7. Shelf: the shelf has been designed to allow good circulation at the rear of the oven and is also fitted with a raised bar to prevent trays or dishes making contact with the back of the oven. To remove a shelf, pull forward until it stops, raise at front and remove.

IMPORTANT

The pans and trays supplied with this appliance are the maximum sizes recommended for use. Larger pans and trays may restrict good circulation of heat, increasing cooking times.

Oven Temperature Control

The temperature in the oven is controlled by a thermostatic gas tap and is variable over the range 130°C to 240°C. The temperatures indicated refer to the centre of the oven and at any particular setting the oven will be hotter at the top and cooler towards the base.

The variation between top and centre, and centre to bottom is approximately equivalent to one gas mark. Good use can be made of the temperature variation in several dishes requiring different temperatures may be cooked at the same time. In this way maximum benefit can be obtained from the gas used to heat the oven. Care should be

taken not to overload the oven, adequate spacing being used to allow free circulation for heat.

OPERATION**Cooking Guidelines**

Best results will be obtained by the shelf positions in this guide. It is not necessary to preheat the oven but advisable for a range of dishes. The oven is capable of full temperature in 15-20 minutes.

Most cookery books give details of the shelf positions and gas mark settings for each recipe. If in doubt about a recipe you intend to use, study the recipe carefully then find a similar dish in our guide and use our shelf position and gas mark setting recommendation.

Shelf positions are from the top down. When roasting with aluminium foil care must be taken that the foil does not impair circulation or block the oven flue outlet.

DO'S AND DON'TS

- DO** read the user instructions carefully before using the appliance for the first time.
- DO** allow the oven to heat before using for the first time, in order to expel any smells before the introduction of food.
- DO** clean the appliance regularly.
- DO** remove spills as soon as they occur.
- DO** always use oven gloves when removing food shelves and trays from the oven.
- DO** check that controls are in the off position when finished.
- DO NOT** allow children near the cooker when in use. Turn pan handles away from the front so that they cannot be caught accidentally.
- DO NOT** allow fats or oils to build up in the oven trays or base.
- DO NOT** use abrasive cleaners or powders that will scratch the surfaces of the appliance.

DO NOT under any circumstances use the oven as a space heater.

DO NOT put heavy objects onto open grill and oven doors.

Leaks

If a smell of gas becomes apparent, the supply should be turned off at the cylinder

IMMEDIATELY. Extinguish naked lights including cigarettes and pipes. Do not operate electrical switches. Open all doors and windows to disperse any gas escape. LPG gas is heavier than air; any escaping gas will therefore collect at a low level. The strong unpleasant smell of gas will enable the general area of the leak to be detected. Check that the gas is not escaping from an unlighted appliance. Never check for leaks with a naked flame, leak investigation should be carried out using a leak detector spray.

MAINTENANCE & SERVICING**IMPORTANT**

- Shut off gas supply at isolating valve, switch off electric supply and ensure all parts are cool before cleaning or servicing
- All servicing must be carried out by an approved competent person.
- After each service the appliance must be checked for gas soundness
- This appliance must not be modified or adjusted unless authorised and carried out by the manufacturer or his representative. No parts other than those supplied by the manufacturer should be used on this appliance.
- If the supply cord is damaged, it must only be replaced by the manufacturer or his representative in order to avoid a hazard.

This appliance needs little maintenance other than cleaning. All parts should be cleaned using warm soapy water. Do not use abrasive cleaners, steel wool or cleansing powders.

When cleaning the burner ring it is essential to ensure that the holes do not become blocked. The control knobs are a push fit

and can be removed for cleaning. They are interchangeable without affecting the sense of operation.

COOKER 3 BURNER GAS HOB (SPRITE ONLY)

IMPORTANT: Before using the appliances for the first time, remove all accessories and packing in the grill and oven, including any surface protection film, i.e. plastic coating. Clean all interior surfaces with hot soapy water to remove any residual protective covering of oil and rinse carefully.

WARNING

- ACCESSIBLE PARTS MAY BE HOT WHEN THE GRILL IS USED, YOUNG CHILDREN SHOULD BE KEPT AWAY.
- WHEN COOKING ALWAYS ENSURE YOUNG CHILDREN ARE KEPT AWAY.

Ensure the gas cylinder is turned on. In the event of a gas smell, turn off at the cylinder and contact supplier. The burners on this appliance have fixed aeration and no adjustment is required. Depending on the gas being used, the burners should flame as follows:

PROPANE - The flames should burn quietly with a blue/green colour with no sign of yellow tips.

BUTANE - Normally on initial lighting, as small amount of yellow tipping will occur and then slightly increases as the burner heats up.

IMPORTANT: The control tap on this appliance operates both the grill and oven burners.

To ensure safe operation it is not possible to operate both burners at the same time.

COOKER OPERATION

Using the hob burners

1. Ensure gas cylinder/supply is connected and turned on. In the event of a gas smell turn off at gas cylinder/mains and contact supplier
2. Flame supervision: Each burner is controlled individually and is monitored by a thermocouple probe. In the event of the burner flames being accidentally extinguished, turn off the burner control and do not attempt to re-ignite the burner for at least one minute.
3. To light: Push in the control knob and turn to full rate - see Fig.2. Hold a lighted match or taper to the burner and push the control knob in and hold. It is necessary to hold the knob depressed after the burner has ignited or approximately 10-15 seconds, to allow the thermocouple probe to reach temperature, before releasing the knob. Should the flame go out when the knob is released, the procedure should be repeated holding the knob depressed for slightly longer.
4. For models fitted with spark ignition the procedure is similar except that the burner can be ignited by depressing the ignition button, which is located on the fascia. If the burner has not lit within 15 seconds the control knob should be released and the burner left for at least 1 minute before a further attempt to ignite the burner.
5. For simmering, turn the knob further anti-clockwise to the low rate position.
6. To turn off: Turn the control knob until the line on the control knob is aligned with the dot on the control panel. Always make sure the control knob is in the off position when you have finished using the hotplate burners.

IMPORTANT: The two in line hob burners on this appliance will support pans from 10cm to 20cm. The single hob burner will support pans from 10cm to 22cm.

WARNING

- GLASS LIDS MAY SHATTER WHEN HEATED. TURN OFF THE HOTPLATE AND ALLOW IT TO COOL BEFORE CLOSING THE GLASS LID.
- REMOVE ALL SPILLAGE FROM THE SURFACE OF THE GLASS LID BEFORE OPENING.

Using the grill**IMPORTANT**

- THE GRILL MUST ONLY BE USED WITH THE DOOR OPEN.
- THE HEAT DEFLECTOR BELOW THE FASCIA SHOULD BE PULLED OUT PRIOR TO LIGHTING THE GRILL. NEVER ADJUST THE HEAT DEFLECTOR POSITION WITHOUT USING HAND PROTECTION I.E. OVEN GLOVES.

1. Ensure gas cylinder/supply is connected and turned on. In the event of a gas smell turn off at gas cylinder/mains and contact supplier.
2. To light: Open door, push in the control knob and turn to full rate.
Hold a lighted match or taper to the burner and push the control knob in and hold. The burner should ignite and the control knob should be held in for 10-15 seconds before release. If the burner goes out, repeat procedure holding control knob for slightly longer.
3. For models fitted with spark ignition the procedure is similar except that the burner can be ignited by depressing the ignition button, which is located on the fascia. Ignition must be carried out with the door open, and if the burner has not lit within 15 seconds the control knob should be released and the grill left for at least 1 minute before a further attempt to ignite the burner.

4. On first use of the grill, it should be heated for about 20 minutes to eliminate any residual factory lubricants that might impart unpleasant smells to the food being cooked. A non-toxic smoke may occur when using for the first time so open any windows and turn on mechanical ventilators to help remove the smoke.
 5. Although the grill does heat up quickly, it is recommended that a few minutes preheat be allowed.
 6. Flame Failure Device (FFD): The grill burner is fitted with a flame sensing probe, which will automatically cut off the gas supply in the event of the flame going out. In the event of the burner flames accidentally being extinguished, turn off the burner control and do not attempt to re-ignite the burner for at least one minute.
 7. It is normal for the flames on this burner to develop yellow tips as it heats up, particularly on Butane.
 8. A reversible grill pan trivet enables the correct grilling height to be achieved.
Fast toasting - trivet in high position
Grilling sausages - trivet in high position
Grilling steak/bacon - trivet in high position
Grilling chops, etc. - trivet in low position
Slow grilling - trivet removed
 9. To turn off: Turn the control knob until the line on the control knob is aligned with the dot on the control panel. Always make sure the control knob is in the off position when you have finished grilling.
2. To light: Open door, push in the control knob and turn to gas mark 9. Hold a lighted match or taper to the burner and push the control knob in and hold. The burner should ignite and the control knob should be held in for 10-15 seconds before release. If the burner goes out, repeat the process holding control knob for slightly longer.
 3. For models fitted with spark ignition the procedure is similar except that the burner can be ignited by depressing the ignition button, which is located on the fascia. Ignition must be carried out with the door open, and if the burner has not lit within 15 seconds the control knob should be released and the oven left for at least one minute before a further attempt to ignite the burner.
 4. Place the oven shelf in the required position and close the door. Set control knob to approximately gas mark 5 and heat the oven for about 30 minutes to eliminate any residual factory lubricants that might impart unpleasant smells to the meals being cooked. A non-toxic smoke may occur when using for the first time so open any windows and turn on mechanical ventilators to help remove the smoke.
 5. Although the oven does heat up quickly, it is recommended that a 10 minute pre-heat should be allowed. The oven should be up to full temperature in about 15-20 minutes
 6. To turn off: Turn the control knob until the line on the control knob is aligned with the dot on the control panel.
 7. Shelf: The shelf has been designed to allow good circulation at the rear of the oven and are also fitted with a raised bar to prevent trays or dishes making contact with the back of the oven. To remove a shelf, pull forward until it stops, raise at front and remove.

IMPORTANT

- The pan supplied with the appliance is multi functional, for use either whilst grilling or when using the oven.
- The handle design allows removal or insertion whilst the pan is in use.

Using the oven

1. Ensure gas cylinder/supply is connected and turned on. In the event of a gas smell

COOKER OPERATION

Oven temperature control

The temperature in the oven is controlled by a thermostatic gas tap and is variable over the range 130°C to 240°C. Approximate temperatures for the settings on the control knob are shown in the table below. The temperatures indicated refer to the centre of the oven and at any particular setting the oven will be hotter at the top and cooler towards the base.

The variation between top and centre, and centre to bottom is approximately equivalent to one gas mark. Good use can be made of the temperature variation in several dishes requiring different temperatures may be cooked at the same time. In this way maximum benefit can be obtained from the gas used to heat the oven. Care should be taken not to overload the oven, adequate spacing being used to allow free circulation for heat.

Cooking guidelines

See user instructions.

DO'S AND DON'TS

DO read the user instructions carefully before using the appliance for the first time.

DO allow the oven to heat before using for the first time, in order to expel any smells before the introduction of food.

DO clean the appliance regularly.

DO remove spills as soon as they occur.

DO always use oven gloves when removing food shelves and trays from the oven.

DO check that controls are in the off position.

DON'T allow children near the cooker when in use. Turn pan handles away from the front so that they cannot be caught accidentally.

DON'T allow fats or oils to build up in the oven tray or base.

DON'T use abrasive cleaners or powders that will scratch the surfaces of the appliance.

DON'T under any circumstances use the oven as a space heater.

DON'T put heavy objects onto open grill and oven doors.

Leaks

If a smell of gas becomes apparent, the supply should be turned off at the cylinder

IMMEDIATELY. Extinguish naked lights including cigarettes and pipes. Do not operate electrical switches. Open all doors and windows to disperse any gas escape.

Butane/Propane gas is heavier than air; any escaping gas will therefore collect at low level.

The strong unpleasant smell of gas will enable the general area of the leak to be detected.

Check that the gas is not escaping from an unlighted appliance. Never check for leaks with a naked flame, leak investigation should be carried out using a leak detector spray.

MICROWAVE OVEN GENERAL USER INSTRUCTIONS

ALWAYS REFER TO THE MICROWAVE OPERATING INSTRUCTIONS SUPPLIED WITH THE VEHICLE

PRECAUTIONS TO AVOID POSSIBLE EXPOSURE TO EXCESSIVE MICROWAVE ENERGY

- a. Do not attempt to operate this oven with the door open since open door operation can result in harmful exposure to microwave energy. It is important not to defeat or tamper with the safety interlocks.
- b. Do not place any objects between the oven front face of the door or allow soil or cleaner residue to accumulate on sealing surfaces.

c. **WARNING** if the door or door seals are damaged, the oven must not be operated until it has been repaired by a competent person (1) door broken (2) hinges and latches (broken or loosened), (3) door seals and sealing surfaces.

d. **WARNING** it is hazardous for anyone other than a competent person to carry out a service or repair operation.

e. **WARNING** liquids or other foods must not be heated in sealed containers since they are liable to explode.

f. **WARNING** only allow children to use the oven without supervision when adequate instruction has been given so that the child is able to use the oven in a safe way and understands the hazards of improper use.

g. **WARNING** when the appliance is operated in the combination mode, children should only use the oven under adult supervision due to the temperature generated. (if provided)

IMPORTANT SAFETY GUIDANCE

WARNING: -To prevent fire, burns, electric shock and other warnings:

Listed below are, as with all appliances, certain rules to follow and safeguards to assure high performance from this oven:

IMPORTANT INSTRUCTIONS

1. Do not use the oven for any reason other than food preparation, such as for drying clothes, paper, or any other non food items or for sterilizing purposes.
2. Do not use the oven when empty, this could damage the oven.
3. Do not use the oven cavity for any type of storage, such as papers, cookbook, cookware etc.
4. Do not operate the oven without the glass tray in place. Be sure it is sitting properly on the rotating base.
5. Make sure you remove caps or lids prior to cooking when you cook food sealed in bottles.
6. Do not put foreign material between the oven surface and door. It could result in excessive leakage of microwave energy.
7. Do not use recycled paper products for cooking. They may contain impurities which could cause sparks and/or fires when used during cooking.
8. Do not pop popcorn unless popped in a microwave approved popcorn popper or unless it's commercially packaged and recommended especially for microwave ovens. Microwave popped corn produces a lower yield than conventional popping; there will be a number of unpopped kernels. Do not use oil unless specified by the manufacturer.
9. Do not cook any food surrounded by a membrane, such as egg yolks, potatoes, chicken livers, etc., without first piercing them several times with a fork.
10. Do not pop popcorn longer than the manufacturer's directions. (Popping time

MICROWAVE OVEN

is generally below 3minutes). Longer cooking does not yield more popped corn it can cause scorching and fire. Also, the cooking tray can become too hot to handle or may break.

11. If smoke is observed, switch off or unplug the appliance and keep the door closed in order to stifle any flames.
12. When heating food in plastic or paper containers, keep an eye on the oven due to the possibility of ignition.
13. The contents of feeding bottles and baby food jars shall be stirred or shaken and the temperature checked before consumption, in order to avoid burns.
14. Always test the temperature of food or drink which has been heated in a microwave oven before you give it to somebody, especially to children or elderly people. This is important because things which have been heated in a microwave oven carry on getting hotter even though the microwave oven cooking has stopped.
15. Eggs in their shell and whole hard-boiled eggs should not be heated in microwave ovens since they may explode, even after microwave heating has ended.
16. Keep the waveguide cover clean at all times. Wipe the oven interior with a soft damp cloth after each use. If you leave grease or fat anywhere in the cavity it may overheat, smoke or even catch fire when next using the oven.
17. Never heat oil or fat for deep frying as you cannot control the temperature and doing so may lead to overheating and fire.
18. Liquids, such as water, coffee, or tea are able to be overheated beyond the boiling point without appearing to be boiling due to surface tension of the liquid. Visible bubbling or boiling when the container is removed from the microwave oven is not always present. **THIS COULD RESULT IN VERY HOT LIQUID SUDDENLY BOILING OVER WHEN A SPOON OR OTHER UTENSIL IS INSERTED INTO THE LIQUID.**

To reduce the risk of Injury to persons:

- a. Do not overheat the liquid.
- b. Stir the liquid both before and halfway through heating it.
- c. Do not use straight-sided containers with narrow necks.
- d. After heating, allow the container to stand in the microwave oven for a short time before removing the container
- e. Use extreme care when inserting a spoon or other utensil into the container.

CARE OF THE MICROWAVE

1. Turn the oven off before cleaning
2. Keep the inside of the oven clean. When food spatters or spilled liquids adhere to oven walls, wipe with a damp cloth. Mild detergent may be used if the oven gets very dirty. The use of harsh detergent or abrasives is not recommended.
3. The outside oven surface should be cleaned with soap and water, rinsed and dried with a soft cloth. To prevent damage to the operating parts inside the oven, water should not be allowed to seep into the ventilation openings.
4. If the central panel becomes wet, clean with a soft dry cloth. Do not use harsh detergents or abrasives on Control Panel.
5. If steam accumulates inside or around the outside of the oven door, wipe with a soft cloth. This may occur when the microwave oven is operated under high humidity conditions and in no way indicates malfunction of the unit.
6. It is occasionally necessary to remove the glass tray for cleaning. Wash the tray in warm sudsy water or in a dishwasher.
7. The roller guide and oven cavity floor should be cleaned regular/y to avoid excessive noise. Simply wipe the bottom surface of the oven with mild detergent water or window cleaner and dry. The roller guide may be washed in mild sudsy water.

CASSETTE TOILET

8. The oven should be cleaned regularly and any food deposits removed;
9. Failure to maintain the oven in a clean condition could lead to deterioration of the surface that could adversely affect the life of the appliance and possibly result in a hazardous situation.

THETFORD C250 CWE CASSETTE TOILET

The toilet is made up of two parts: a permanently fixed part and a Waste Holding Tank that is accessible from the outside. The removable Waste Holding Tank is located under the toilet bowl and can be removed via a door on the outside of the caravan.

These instructions cover the C-250CWE this has its own flush-water tank.

PARTS

- a) Removable Seat and Lid
- b) Swivelling Toilet Bowl
- c) Blade Handle
- d) Flush Button
- e) Waste Holding Tank Level Indicator
- f) Water Filling Door (only if toilet has own flush-water tank)
- g) Rotating Emptying Spout
- h) Automatic Pressure Release Vent
- i) Sliding Cover
- j) Removable Mechanism
- k) Vent Plunger
- l) Pull-Out Handle
- m) Wheels
- n) Blade Opener
- o) Access Door to Waste Holding Tank
- P) Electric blade opener
- Q) Electric ventilator
- R) Waste pump-out system
- S) Waste holding tank mult-level indicator
- T) Flush water tank level indicator

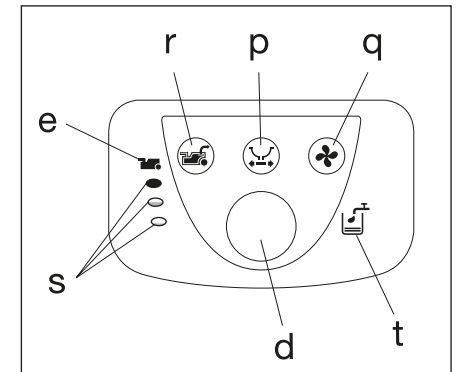
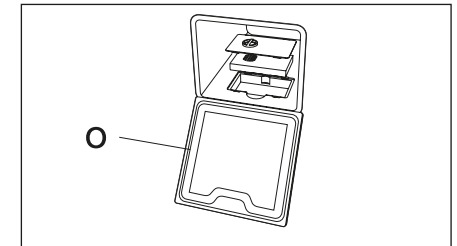
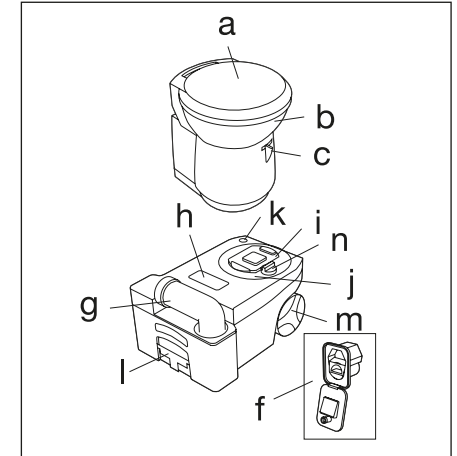

CASSETTE TOILET

Control panel

Preparing for use (standard)

1. Open the access door on the outside of your caravan
2. Remove the Waste Holding Tank by pulling the safety catch (which holds the tank in place) upwards.
3. Pull the Waste Holding Tank outward to the stop. Tip it slightly and take the tank fully out.
4. Place the tank upright and turn the rotating emptying spout upwards. The emptying spout ensures that the tank can be easily and hygienically emptied.
5. Remove the cap, with the measuring cup inside, from the emptying spout and pour the correct dosage of Thetford toilet fluid (see product label) into the holding tank. This avoids unpleasant smells and keeps the inside of the tank clean. Next add approximately 2 litres of water - enough to ensure that the bottom of the Waste Holding Tank is covered. For more information on Thetford toilet fluids, see last page of the Thetford user manual. Screw the cap back onto the emptying spout and turn back to its original position.

Note. The Emptying Spout Measuring Cap is supplied in the same packaging as the Thetford user manual.

WARNING! Never add toilet fluid directly via the blade or the toilet bowl as this could damage the lip seal of the Waste Holding Tank. Always pour the fluids via the emptying spout.

6. Slide the Waste Holding Tank back into its original position via the access door. Make sure that it is secured with the safety catch. Close the access door and lock it. Your Thetford toilet is now ready to use.

WARNING! Never use force if you cannot get the tank back into place easily. This may cause serious damage. If blockage occurs, always check if the blade handle is in the correct (closed) position.

7. For toilets with own Flush-Water Tank: Open the water filling door and fill the flush-water tank with the correct dosage of Aqua Rinse. This Thetford toilet fluid keeps the flush water fresh and improves the flushing. Next, fill up the flush-water tank with clean water (approximately 8 litres) using a jerry can or hose. Your toilet is now ready to use.

Preparing for use with optional features

8. Automatic Ventilator: Open the access door on the outside of your caravan and remove the Waste Holding Tank (as described above).
9. Remove the filter housing cover and if no filter is present, place a new filter into the filter housing. Peel off the sticker lids on the filter. Place back the cover of the filter housing.

Using the toilet (standard)

10. Turn the bowl to the desired position with the lid closed and using both hands.
11. To activate the control panel, press the flush-button once. The control panel display will stay activated for approximately 5 minutes. Run some water into the bowl by pressing the flush button again briefly.
12. The toilet may be used with the blade open or closed. To open the blade, slide the blade handle under the toilet bowl sideways. After use, open the blade (if still closed) and flush the toilet by pressing the flush button for several seconds (if necessary re-activate the control panel). Close the blade after use.

IMPORTANT Warning Notice! If your toilet has its own flush-water tank, please make sure that you do not travel with a flush-water tank that is too full. Do not travel with water in the toilet bowl. Failure to adhere to this notice may result in water damage to your caravan or motor home.

Emptying

The Waste Holding Tank has a capacity of 18 litres and requires emptying when the red light (LED) on the toilet control display lights up, when the Waste Holding Tank only has capacity for approximately 2 more litres, which is no more than two to three further uses. Make sure that the blade is closed. Open the access door located outside the vehicle, pull the safety catch upwards and remove the Waste Holding Tank.

16. Place the Waste Holding Tank in an upright position (Pull-Out Handle at the top, Wheels at the bottom). Slide the handle sideways - to the front of the tank - until it snaps out of its locked position.
17. Pull the handle up and wheel the Waste Holding Tank to an authorised waste disposal point.
18. Push the handle back into its locked position. Turn the emptying spout upwards and remove the cap from the spout. Hold the Waste Holding Tank in such a way that during emptying you can operate the vent plunger with your thumb. To empty the tank without splashing, depress the vent plunger while emptying the tank. After emptying, rinse the tank and blade thoroughly with water.

WARNING! Do not seriously shake the tank or use high pressure water cleaners. This may cause damage to the tank's interior.

Note. The vent plunger should only be depressed once the emptying spout is pointing downwards. Prepare the toilet for re-use if required. Slide the Waste Holding Tank into the toilet and close the access door.

Important! It is vital that the correct amount of toilet fluid is added to ensure the proper breakdown of the waste in the holding tank. Only use the system when the tank is full. Using the system too often on an empty tank can cause damage to the pump, which could cause the system to fail.

Cleaning and maintenance

The toilet should be cleaned and maintained regularly, depending on the amount of use. To clean Thetford toilets, we advise using water and Thetford Bathroom Cleaner.

Note. Never use bleach, vinegar or other powerful household cleaners that contain these substances. These may cause permanent damage to the seals and other toilet components.

Toilet bowl

- Squirt Thetford Bathroom Cleaner into the toilet bowl.
- Flush the toilet bowl with water and wipe down the rest of the toilet with a damp cloth.
- Clean seat and lid The seat and lid can easily be removed: Lift the seat and lid assembly and pull the round pins (inside the assembly) outwards from the pin holes. After cleaning, replace the seat and lid by positioning the round pins in front of the pin holes and push the lid and seat downwards.
- To keep your flush water fresh and to prevent deposits from forming in your toilet bowl, add a correct dosage of Aqua Rinse in your flush water tank, if present, on your toilet.

Tip! For a really shining toilet, dry with a soft dry cloth after cleaning.

CASSETTE TOILET

Waste holding tank

To keep your Waste Holding Tank fresh and clean, Thetford has developed a number of different toilet fluids. Thetford toilet fluids suppress smells, reduce formation of gas, promote breakdown of toilet waste and increase the life span of a mobile toilet. See page 46 of the Thetford user manual for more information (=matrix). We advise a thorough cleaning of the Waste Holding Tank once each season. Next to using Thetford's Cassette Tank Cleaner, the powerful cleaning agent for the periodical cleaning of the Waste Holding Tank of your toilet, we suggest the following:

- Remove the removable mechanism from the Waste Holding Tank by turning it anti-clockwise and rinse it under a tap.
- Remove the cover plate from the Automatic Pressure Release Vent by prising it up using a small screwdriver. Use one hand to push the Automatic Pressure Release Vent open while holding the float of the Automatic Pressure Release Vent on the inside of the tank with the other hand. Push the float upwards, turn it 180 degrees and remove it from below. Remove the rubber seal underneath the float. Rinse the float and rubber seal under a tap. Replace the Pressure Release Vent using the same method in reverse.

The rubber seals in the toilet (the lip seal, the mechanism seal, the automatic pressure release vent seal and the cap seal) should be regularly cleaned with water and treated with Thetford High Grade Seal Lubricant. This will ensure that the seals remain flexible and in good condition. If the toilet is not to be used for any length of time, it is important to treat the seals with Thetford High Grade Seal Lubricant after cleaning.

Note. Never use Vaseline or any vegetable oil except olive oil. These may cause leakage or malfunction. The lip seal is a part of the toilet that is subject to wear. Depending upon the extent and manner of use, the seals will become less effective and will need replacing periodically.

Winter operation

You can use your Thetford Cassette Toilet as normal in cold weather as long as the toilet is situated in a heated location. If there is a risk of freezing we advise that the toilet is drained by following the instructions under 'Storage'. For environmental reasons the use of antifreeze, such as that used in car radiators, is not recommended.

Storage

It is important that you follow the instructions below if you do not expect to use your Thetford toilet for a long (winter) period.

- Activate the Control Panel by pressing the flush button. Open the blade and press the flush button until water stops flowing into the bowl. Close the blade. Open the access door on the outside of your caravan or camper and empty the Waste Holding Tank at an authorised waste dump. Follow the instructions for cleaning and maintenance. To allow the Waste Holding Tank to dry, do not place the cap back on the emptying spout of the tank.
21. If the toilet has its own flush-water tank, place a sufficiently large bowl under the drain tube to catch the remaining water from the flush-water tank and remove the drain plug. When no more water exits, put the drain plug on the drain tube, put it back in its original position and close the access door. If the toilet is connected to the vehicle's water tank, please follow your vehicle's instructions for draining the central water system. Thetford warranty refer to the Thetford user handbook.

THETFORD CASSETTE TOILET

CASSETTE C-200 CW, C-200 CWE AND C-402C

The toilet section of the C-200 includes a rotatable bowl, removable seat and cover, a console with a flush handle/flush buttons, a built in flush-watertank and a waste level warning indicator. The valve blade handle is located underneath the bowl.

PREPARING FOR USE

1. Open access door pull retaining clip upwards (fig. 1).
2. Remove holding tank by pulling straight out. When holding tank hits the stop, tilt front end downwards slightly and remove (fig. 2).
3. Position tank vertically and swivel pour out spout upwards (fig. 3).
4. Remove the cap of the pour out spout. Add required quantity of toilet fluid through pour-out spout then add approx. 2 litres of water through the spout to cover holding tank bottom. Replace cap and return pour out spout to its original stored position (fig. 4).

Note: Warmer weather or longer intervals between emptying the waste tank may require additional toilet fluid. Use only Thetford toilet fluid to achieve the best results.

Caution: Never add toilet fluid directly into toilet bowl.

5. Slide the holding tank into position through access door (fig. 5).
6. Make sure the holding tank is secured by the retaining clip. (fig. 6).
7. Open the water fill door and add 50 ml of Aqua Rinse. Aqua Rinse results in a better flush and improves the hygiene of the toilet. Then fill the water tank with fresh water using a jerrycan or a hose. Tank capacity is 7 litres (fig. 7).

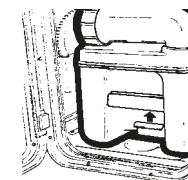

Fig. 1

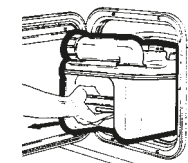

Fig. 2



Fig. 3

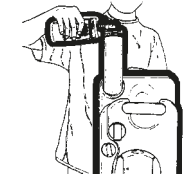

Fig. 4

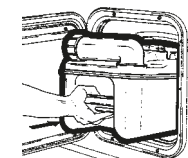

Fig. 5

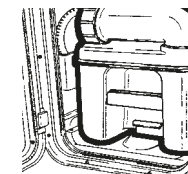

Fig. 6



Fig. 7

THETFORD CASSETTE TOILET

OPERATION

8. Turn the bowl in the most comfortable position (fig. 8).
9. C-200 CW only: Before using the toilet it is recommended to flush some water into the bowl by lifting and pressing down the flush handle (fig. 9).
- 9a. C-200 CWE only: Before using the toilet it is recommended to flush some water into the bowl by pressing and releasing the flush button (fig. 9a).
10. The toilet may be used with the blade open or closed. Pull valve handle towards you to open (fig. 10).
11. C-200 CW only: After use, open valve blade (if still closed) and flush, lift the flush handle and press it down (fig. 11). After flushing, close the blade by turning the blade handle.



Fig. 8

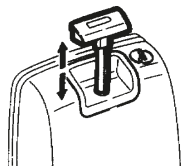

Fig. 9

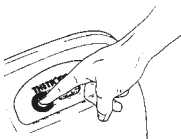

Fig. 9a

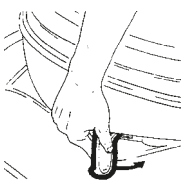

Fig. 10

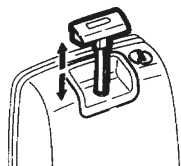

Fig. 11

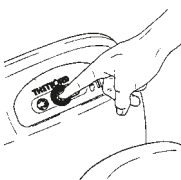

Fig 11a

- 11a. C-200 CWE only: After use, open valve blade (if still closed) and flush, press the flush button (fig. 11a). After flushing, close the blade by turning the blade handle.

Note: C-250 S Operation: The flush water is drawn from a separate on board tank rather than the toilets' own water tank. This method minimises the toilet size in the bathroom giving you more room and maximises the number of flushes you can get from a single fill of your own on board tank.

As your on board tank also serves other purposes you should never put Thetford Aqua Rinse into this tank.

Instead Thetford suggest that Aqua Rinse can be applied directly to your toilet bowl with the means of a common domestic trigger spray bottle. Thetford Aqua rinse can be mixed with water at a dilution rate of 10:1 and then applied to the bowl after each use.

The waste holding tank is located underneath the toilet and is removed for emptying from the outside of the vehicle through an access door. A rotating pour out spout, automatic holding tank vent, air release valve, valve blade, carrying handles and hand grip are incorporated in the waste holding tank. A sliding cover guarantees optimal hygiene.

EMPTYING THE HOLDING TANK

The holding tank capacity is approx. 17 litres and the tank should be emptied when the waste-level indicator lights up. The waste level indicator lights up when the holding tank contains more than 15 litres of waste.

CAUTION: Do not allow the holding tank to become overfilled. See trouble shooting section for emergency emptying procedure.

12. Open access door and remove the holding tank. The holding tank can only be removed when the valve blade is closed (fig. 12).
13. Carry the holding tank to a normal household type toilet or other authorised disposal point. Place the holding tank in vertical position and rotate pour out spout upwards (fig. 13).
14. Remove the spout cap. Grasp unit by upper carrying handle nearest to pour out spout. Place other hand on upper rear hand grip so that vent button can be depressed with the thumb while emptying. This ensures a smooth outflow of the tank contents. (fig. 14).

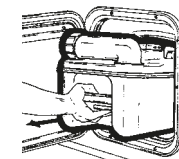

Fig. 12



Fig. 13

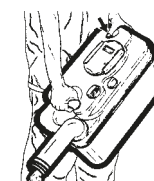

Fig. 14

Note: Only depress the vent button when pour out spout is pointed downwards.

Rinse the holding tank with clean water.

For preparing for use again, see steps 1 to 7.

THETFORD CASSETTE TOILET

CLEANING AND MAINTENANCE

The lipseal and the seal of the automatic vent are made of rubber and therefore these parts need regular maintenance (depending on frequency of use, once or twice a month).

Lipseal: Remove the sliding cover. Open the valve-blade by turning the blade-opener knob anticlockwise. Clean the seal with water. Dry the seal and grease with silicone spray/oil or vegetable oil.

Seal of automatic vent: Turn the automatic vent 60° anticlockwise and remove gently. Clean the seal with water. Dry the seal and grease with silicone spray/oil or vegetable oil.

To clean the holding tank, empty the tank, and rinse with clean water. Use a mild soap to clean toilet bowl, seat and cover, as well as exterior of toilet unit and holding tank.

NOTE: Do not use strong household detergents or cleaners that contain chlorine, solvents or acid contents.

WINTERING/STORAGE

The Thetford Cassette C-200 CW/CWE is easily winterised for storage.

Empty remaining fresh water into the bowl by activating the flush handle up and down (C-200 CW) or by pressing the flush button (C-200 CWE).

Once pump has been cleared and water flow has stopped completely, release into waste tank. Remove waste tank and empty contents in normal way.

To remove any remaining water from the fresh water tank. Place a container underneath the drain plug and remove drain plug.

When procedure has been completed replace drain plug and waste holding tank. Clean the seals and grease them after drying (see cleaning and maintenance).

Leave the blade of the holding tank open. Do not replace cap on the pour out spout, to ventilate the holding tank. (Also grease the seal of the pour out spout cap.)

COLD WEATHER USE

The toilet can be used in cold weather conditions provided that the toilet is in heated surroundings. If this is not the case, you can use a nontoxic antifreeze (propylene glycol) or an antifreeze such as those used in car radiators. Add the antifreeze to the water in the tank. Add the quantity specified in the instructions, paying due regard to the safety instructions.

HIGH ALTITUDE AND WARM WEATHER USE

Pressure may build up in the holding tank if the tank is not inserted while driving at high altitudes or in warm weather conditions. The automatic holding tank vent will vent the tank when there is over- or under-pressure. High temperatures may require additional Thetford toilet fluid.

CASSETTE TOILET FAULTS

CASSETTE TOILET

Fault	Remedy
Bowl does not drain when toilet is flushed. Cassette is overfilled	DO NOT REMOVE CASSETTE. While inside the caravan turn flush knob anti-clockwise to open valve blade and leave it in the open position. Open access door on side of caravan. Rotate pour-out spout outward. Place appropriate size container under spout cap. Remove cap carefully. Allow bowl contents to drain into container. This will lower the water level in the bowl. Replace cap and return pour-out spout to stored position. DO NOT REMOVE CASSETTE. Go inside the caravan and turn the flush knob clockwise to close valve blade. Now, the cassette may be removed following the normal removal and emptying procedure.
Odours	Use proper amount of holding tank deodorant specified on bottle.
Soiled bowl after flushing	Partially fill bowl to cover soiled portion of bowl. Next flush will dissolve waste. Tip: Leave valve blade open during use.
No power to add water to toilet bowl	Check cassette safety sensor switch and fuse-holder for proper engagement and operation. Note: Cassette has to be removed to reach switch and fuse. Insert cassette and try adding water to toilet bowl. Toilet can be flushed manually. Add water. Add water to bowl from a separate container. Turn flush knob anti-clockwise to open valve blade. Turn clockwise to close valve blade.
Cassette cannot be removed	Check for obstacles under retaining clip. Depress retaining clip several times to check operation. Remove cassette. Flush knob and valve blade in partial open position. Close valve blade by moving knob clockwise. CAUTION: If valve blade is open during cassette removal, severe damage to system can occur. Never force insertion or removal of the cassette tank.
Valve blade mechanism sticks or is hard to open	Spray light film of silicone on blade.
Major unit malfunction	Contact your original Caravan Dealer.

EXTERNAL BBQ POINT

CARAVANS WITH EXTERNAL BARBEQUE POINT

Models equipped with an external barbeque point can be used to power any gas appliance suitable for the gas used in the caravan, at the working pressure shown on the label in the barbeque outlet box. Please note when using the outlet that the fitted regulator will allow a maximum of 1.5kg per hour of gas to be taken from the gas bottle. Therefore the consumption of gas from both the appliances within the caravan and the appliance connected to the barbeque point cannot exceed a total of 1.5kg per hour at any one time. If you are in any doubt please consult your dealer for advice. To use point proceed as follows:

1. Fit male tail connector from despatch kit to your barbeque or appliance ensuring a gas tight joint. The work should be carried out by a competent person; if in any doubt consult your dealer.
2. Open box lid by pulling tab on bottom edge and lifting.
3. Insert tail connector on appliance into female coupling, twist to engage and lock.
4. Open gas locker on caravan, ensure gas bottle tap is open and supply is connected to regulator.
5. Light and operate appliance to its instructions.

Please note that you cannot open the gas supply until the nozzle has been inserted.

In the interest of safety all external hose lengths should be kept to a minimum and attachments secured correctly.

WARNING: Care should be taken when using the external barbeque point.
Never barbeque next to an awning or tent.

WARNING: The caravan barbeque point should only be used as an outlet point for gas, never connect a gas bottle direct to the outlet.

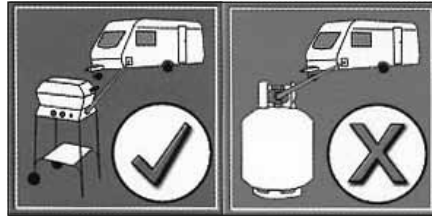

TV INLET IN BATTERY BOX

CARAVANS WITH TV INLET IN BATTERY BOX

Models equipped with TV points in the battery box have the facility to take an external signal and supply that signal to TV points within the caravan.

Caravans equipped in this way feature a direct link from the connection point in the battery box, to an auxiliary connection point at the primary TV position within the caravan. The primary TV position is that which also features an AV outlet plate (see later text).

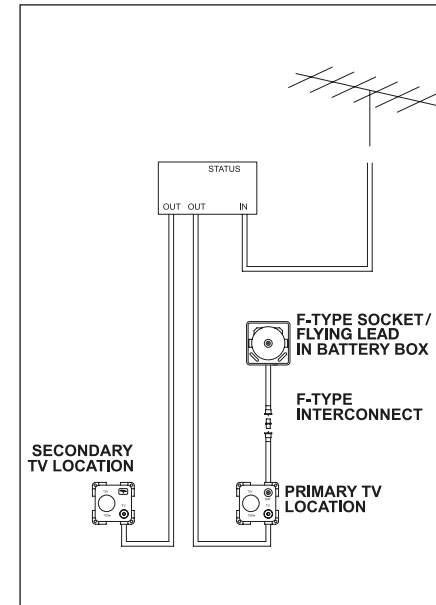

The direct link can be used to:

1. Supply an external signal (caravan site TV feed) to the primary TV position
- Connect the socket in the battery box (on flying lead depending on model), with a suitable lead, to the appropriate socket on the caravan site supply post. As the connector in the battery box is a screw on 'F-type' connector, an adaptor to convert this to a 'push-on' co-ax connector, which may be required, has been supplied with your caravan.

- Locate the primary TV position within the caravan. At the 12V, TV and SAT socket, connect your TV to the output from the socket marked SAT with a suitable lead.
2. Connect an external satellite dish to a decoder within the caravan. (The direct link uses F-type interconnects throughout to allow the decoder and dish to communicate correctly)
 - Connect the dish to the socket (or flying lead) in the battery box with a suitable lead. The F-type to co-ax adaptor should not be used.
 3. Supply a signal from within the caravan to the exterior of the caravan
 - Connect the output from your VCR, DVD player or other device to the SAT connection on the 12V, TV and SAT socket at the primary TV position.
 - Connect your receiving device (TV or similar) to the socket in the battery box with a suitable lead.

As can be seen from the simplified schematic, when multiple TV locations are present in a van, all of these receive signals from the TV aerial connection box. Using adaptors and link cables which are readily available, it may be possible to re-direct a signal from the 'SAT' connection at the primary TV location, up to the aerial connection box to be then distributed to other TV positions within the caravan. Please remember that as the number of connections increases the quality of the signal reduces.

Supplier fitted / supplied entertainment equipment

Audio-visual equipment may have been fitted by your dealer, or supplied with the caravan, depending on the specification of the caravan. Although not specific, below are details of the types of equipment which would be fitted as appropriate to the specification of the caravan:

CD/MP3/tuner with auxiliary input

Where provision has been made in the furniture to install a head unit similar in appearance to that fitted in the dashboard of a car. The unit operates as a CD player and FM/AM radio. In addition MP3 files stored on a CD can be read and played by the unit. An auxiliary input on the front of the unit allows a separate MP3 player to be connected from that player's headphone socket. (A separate lead may be required).

Speakers mounted in the front locker of the caravan are connected to this head unit for a stereo sound output. A retractable AM/FM aerial on the side of the caravan, or concealed in furniture with the head unit, enables reception of radio stations.

STATUS 530 DIRECTIONAL TV AND FM RADIO ANTENNA

(model dependant)

Firstly determine the approximate location of the nearest transmitter and whether the signals are horizontally or vertically polarized. For assistance ask your site operator or check antennas in the vicinity

1. Loosen the Mast Locking Collar and Wall Bracket and raise the antenna. Turn the mast to direct the Antenna towards the TV transmitter.

The RED spot on the bottom of the mast indicates the front of the Antenna.

2. When receiving vertically polarized signals, rotate the winder anti-clockwise to cant the antenna through 90°.

DO NOT over tighten or use undue force on the winder.

3. Switch ON the Power Pack and the RED LED will illuminate.
4. Check the gain control switch is set to normal – NML.
5. Tune your television to the strongest signal. You may need to adjust the direction of the mast to achieve the best quality picture.
6. Secure by tightening the Mast Locking Collar and Wall Bracket

REMOVING THE ANTENNA

A permanently fitted Status can be easily removed leaving only the Mounting Foot and rubber gaiter.

1. Unplug the antenna from the Power Pack.
2. Loosen the Mast Locking Collar and Wall Bracket and lift off whilst feeding out the cable.
3. Push the Blanking Cap supplied into place.

IMPORTANT – The Blanking Cap is a temporary seal and is not for long term use.

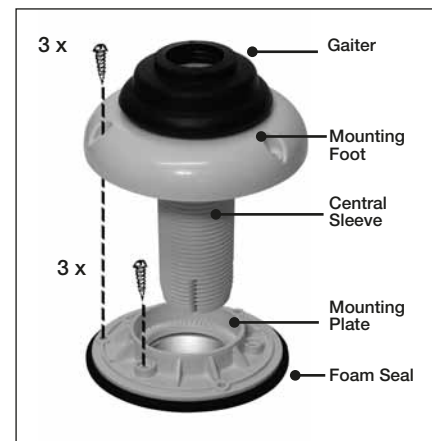

WARNING: Always ensure the aerial is lowered before driving off.

BEDDING

Sleeping bags and duvets can be compressed into small spaces and can be ready to use in minutes.



Lower single beds assembly (Figs. A & B)

1. Lower dinette table and place between the recess in both seats.
2. Arrange seat cushions as appropriate.

BEDDING

Double bed assembly (Fig. C)

1. Grip front of slatted bed and walk backwards until bed is fully extended.
2. Arrange seat cushions as appropriate.



Fig. C

Lift-up bunks

1. Release catches, one at a time.
2. Release press studs on the bed board.
3. Grasp the bunk as shown and pull carefully in direction of arrows.
4. The bunk is designed to automatically move into the correct position.
5. Where a bed board is fitted, unfold and make sure it is secured by press studs when lifted into position. (The bed board is required to protect both the occupant and the window from damage during use of the bunk.)
6. Locate safety boards.
7. Arrange seat cushions as appropriate.

Bunks are designed to carry a child to a maximum of 70kg (11 stone)

WARNING: Use upper bunks for sleeping only, with the provided protection against fall out in position

WARNING: Care shall be taken against the risk of fall out when the upper bunks are in use by children especially under 6 years of age, these bunks are not suitable for use by infants without supervision.



BLINDS / DOORSCREEN / ROOF LIGHT

OPERATING INSTRUCTIONS FOR SOFTROLLO BLINDS

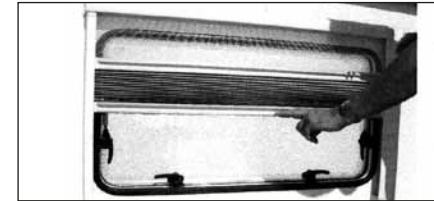

Hold the operating aluminium bar in the middle and raise or lower the blind and flyscreen independently, operating together will require excessive force in operation.

Care instructions: Clean the blind only with a damp sponge. Clean on a regular basis to avoid dirt particle build up as this can damage the blind material.

Use only water or with mild suds or a vacuum cleaner.

In order to avoid material fatigue, do not leave the flynet closed for a long time.

Maintenance

If operation of the soft Rollo blind is exceptionally stiff, it is possible to spray the guide - legs (left and right) with a Teflon - spray. This will ease both the operation of the blind and avoid any interruption/malfunction from deposits in the guide legs which may affect the operation.

DOORSCREEN

When drawing or releasing the doorscreen, care should be taken not to let it spring back freely, this may result in damage to the screen or its fittings.



Always pull the doorscreen close to the centre. It is not advisable to pull close to the top or bottom as this will cause snagging and uneven running.

Caution: When opening or releasing the doorscreen, care must be taken to avoid trapping fingers.

Do not allow the doorscreen to slam open.

The door flynet operates independently of the door by sliding across the door threshold.

ROOF LIGHTS

When opening the roof lights, care must be taken to release the locking mechanism as the unit is raised.

Roof lights must be fully closed when towing.

Roof lights provide varying levels of fixed ventilation.

WINDOWS

To open turn catches through 90°. Push open the window to the desired position and tighten stays.

To close the window, loosen stays and slowly close again, turn the catches through 90° to close.

All opening windows have two catch positions. The first position is for ventilation the second seals the window from ventilation and rain.

WINDOWS/ ROLLER BLIND ADVICE

In case of prolonged exposure to the sun roller blinds should not be completely closed as this could cause excessive heat concentration at the top of the window, due to characteristics of the glazing material the windows could be adversely affected.

Roller blinds that shade from the bottom upwards it is necessary to leave a gap of a few centimetres open at the top, this way the heat between window and blind can escape. A fly screen does not cause an obstruction.

Roller blinds that shade from the top downwards must be kept completely open, or be opened regularly to allow the heat to escape.

Keeping the windows in ventilation position allows heat to escape.

Never fully close a roller blind system when storing the vehicle or when not in use for longer periods!

Therefore for optimal window life it is recommended:-

- Blinds starting at the bottom of the window a gap should be provided for ventilation at the top with the window in its ventilation position.
- For vehicles containing blinds from the top downwards or with other types of reflective blinds / curtains, please make sure that these blinds are also ventilated or not fully closed.

Ensure that all windows and roof vents are closed when the vehicle travels on the road.

HEKI-2 ROOF LIGHT (SEITZ)

The lift/tilt roof light can be set in 3 positions by means of pneumatic springs.

Position 1 lifts the pane 12mm without allowing rain to enter the caravan.

Position 2 sets the pane to a 150mm opening and locks with a bar.

Position 3 opens the pane through 55°.

A fully adjustable flyscreen and black-out screen are built into the inner frame. The flyscreen can be drawn independently and the black-out screen is variable for partial or full black-out.

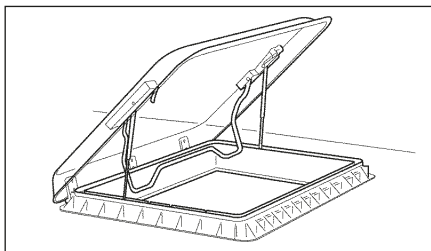

Forced ventilation functions via a brush lined duct instead of a ventilated pane.

A cover hood can be fitted for winter protection.

Heki-2 roof lights provide 13,200mm² of fixed ventilation.

MINI HEKI ROOFLIGHT

To open depress button and push bar upwards. The rooflight has two open ventilation positions and a fully open position.

The blind and flynet operate independently of each other and are engaged by connecting to each other and sliding.

Heki care instructions: Clean the blind only with a damp sponge. Clean on a regular basis to avoid dust/ dirt particle build up as this can damage the blind material. Use only water or with mild suds or a vacuum cleaner.

In order to avoid material fatigue, do not leave the flynet closed for a long time.

CARE OF LAMINATE TOPS, TABLES, FURNITURE AND DOORS

DO NOT use abrasives, chemically treated cloths or aggressive detergents as these may cause damage

DO NOT place hot objects on laminated surfaces i.e. tops, tables. Any temperatures 70°C and over will cause permanent damage.

Clean worktop surfaces, furniture and door fascias with a soft, slightly damp cloth, dry off with a soft cloth.

DOORS

In order to provide customers with the latest designs of door furniture it is possible, due to the use of natural wood, that warping may occur. This should not detract from the correct functioning of items fitted in the caravan.

Information

During the normal travelling vehicle vibration and flexing may cause some of the furniture doors to become out of alignment.

For your convenience many hinges are adjustable.

TABLES

Slide the top of the chest of drawers forward to form a convenient table. Lift the rear portion to slide the top away. (Fig. A)



CAUTION: When erecting the free standing table, be careful to avoid trapping fingers.

TABLE STORAGE

To avoid damage care must be taken when removing tables from their stored position.

Where two tables are stored together in a low level storage area care should be taken to remove the table positioned opposite the hinged edge first.

Tables stored in the table storage compartment must be securely clipped into place whilst in transit.

12V READING LAMP

WARNING 12v tungsten reading/ spotlamps generate high temperatures when in use, the body, lens/ bulb may become very hot. NEVER make directional adjustment in the direction of flammable materials i.e. curtains, nets or blinds.

TRIGGER SHOWER HEADS

- Squeeze trigger to release water. Release trigger to stop. Rotate trigger to gain permanent water flow, lower to stop.
- Care should be taken as water may become hot temporarily when switched on until it mixes and regulates.
- Small children should be supervised at all times when using the shower.
- We recommend unfastening the trigger shower head before travelling and storing safely to prevent it becoming detached whilst towing.

FIXING OF AWNINGS

In order to avoid puncturing the outer skin of the caravan wall, it is recommended that awning poles are fixed to your caravan using load spreading eyelet pads or rubber sucker pads.

Attaching awning brackets and associated fixings to your caravan by using mechanical methods which pierce the outer skin of the caravan wall can allow water ingress which will invalidate the product warranty.

Important:

Care must be taken when using an awning as poles and suckers can cause damage to exterior side panels.

Awnings should be taken down in strong winds to protect the side panels from cosmetic damage and dents from the awning poles.

Note:

Awnings should be kept ventilated when discharging products of combustion exhaust into them.

Awning Sizes

Due to the various awning types and sizes the awning sizes provided in the Service and Warranty Handbook are for guidance only.

Specific awning sizes must be confirmed with the dealer or awning manufacturer prior to purchase.

COLOUR REFERENCE

If a customer requires touch-up paint or a respray of a caravan, the correct colour code for all white components is Fiat White 249.

Please be aware that colours can fade over time, and therefore, if the vehicle is more than a few years old, it is suggested a colour match be obtained.

Silver caravans do not have a specified colour code, and therefore, a colour match must always be obtained.

DROP DOWN TV MECHANISM

In some models, a drop down TV mechanism is used. Customers are reminded to engage both positive locks, on the underside of the TV mechanism before travelling. Failure to do so may result in damage of the TV unit or the TV shelf itself.

The inner dimensions (i.e. maximum TV size) for this unit is 336mm high x 390mm wide x 70mm deep

FRONT LOCKER AND SUNROOF

The front locker is made from ABS thermoformed plastics, which are easy clean textured surfaces. To ensure long life and prevent damage you must not use any cleaning materials including solvents or aggressive cleaning materials. We recommend the use of warm soapy water, applied with a damp cloth.

Where a front sunroof is fitted, directly above the front windows, it is recommended that the blind be left open during use (or storage) in high temperatures or direct sunlight, to avoid a build-up of heat within this non-opening window.

TO ADJUST THE TENSION OF THE HORREX BLIND:

In each corner piece there is an cord tensioner (see photo). By unscrewing the hexagon screw, the cord can move through the cord tensioner. When you pull the cord, the tension will get higher, when you let it move back the tension will get less.

STEP ON HITCH COVER

Where a step on hitch cover is fitted, customers are reminded only to stand on the designated areas, identified with black anti-slip matting. Stepping elsewhere on the hitch cover may result in damage to the hitch cover.

Models without a step on hitch cover are not suitable for standing on and failure to follow these simple instructions may result in premature failure or cracking which will not be covered by any guarantees (including extended warranties).

CYCLE RACKS

The Swift Group allows the fitment of a two cycle rack to our caravans and we have made provision for fixing blocks on most models for this purpose.

Due to the complex nature of a cycle rack, the different models available and the need to break into the habitation box (therefore, having a potential of a leak), we suggest this modification only be carried out by a competent person, ideally, a Swift Group dealer or Authorised Repairer.

Please be aware a cycle rack can not be fitted onto a model where there is a rear escape window. Please confirm this with your Swift Group Dealer.

CARAVAN MOTOR MOVERS

The design and fitment of a caravan motor mover shall be in accordance with the NCC Code of Practice 305 and you should ensure you receive a signed installation certificate of compliance from the installer.

Failure to do so may invalidate your warranty

FITTED EQUIPMENT

Vehicle modification and non-standard parts	160
Caravan movers	160
Caravan exterior	160
Caravan interior	162
Winterisation/storage	164
AL-KO chassis	168
AL-KO ATC control system.....	168
Axle types	173
Operating instructions for AKS 3004	178
AKS 3004 Delivery Specifications	179
Manoeuvring.....	181
Chassis Maintenance & Cleaning	182
Chassis trouble shooting	186
Chassis accessories	189

VEHICLE MODIFICATIONS & NON-STANDARD PARTS

As the owner of a Swift Group Product, you are able to make any modifications you wish, either by yourself or through a dealer, without affecting the Swift 3/6 Year Warranty.

However, please be aware that any issues, resulting directly or indirectly, from a modification or fitment of a non-standard part, will not be covered by The Swift Group Warranty.

WD40 is not recommended for external or internal use

WD40 attacks paintwork and sealants.

If a lubricant is required for Interior hinges, Sliding door tracks, Bottle box hinges, Exterior door hinges, Plastic tracking etc. We recommend "Ambersil 40+" this is readily available from most DIY/ Automotive spare part retailers

Before carrying out any DIY work within the warranty period (3/5) years please check with your Swift Group dealer.

CARAVAN MOVERS

If thinking of installing shock absorbers or a caravan mover as an after fit it is advisable to consult your dealer, as this may not be possible with shock absorbers (if fitted).

CARAVAN EXTERIOR

Aluminium Panels

The stove enamelled paintwork is very durable and easy to clean owing to the high gloss properties.

Plastic Panels (GRP/ABS)

These are used for front and rear panels and, in some cases for the roof.

Cleaning

For both aluminium panels and plastic panels.

1. Wash the caravan regularly with mild detergent. Rinse with cold water and leather off.
2. For better protection a similar coloured good quality car wax may be applied.

For sealed areas a mild soap is the best way to clean without affecting the sealant.

Acid or alkaline based cleaners or solvents should not be used.

WARNING: Under no circumstances use any abrasive cleaning agents or solvents on the exterior panels.

Care should be taken as the silicon in some polishes can attack the rubber used on the exterior for seals and gaskets.

Acrylic Windows

Wash windows carefully, as you would with the paintwork of your car, do not scrub windows prior to removing surface dirt and film with a hose pipe - trapped dirt could cause scratching.

Wash with a solution of warm soapy water, windows can then be dried off with a leather.

Small scratches can be removed, consult your dealer.

Catches and stays do not require any special attention or lubrication.

Condensation

What is condensation?

Condensation is the change of water from its gaseous form (water vapour) into liquid water. Condensation generally occurs in the atmosphere when warm air rises, cools and loses its capacity to hold water vapour.

As a result, excess water vapour condenses to form droplets.

Why condensation occurs

Condensation occurs when warm moist air meets a cold surface. The risk of condensation therefore depends upon how moist the air is and how cold the surfaces of the vehicle are. Both of these depend to some extent on how the vehicle is used. In a Caravan with a cold outside wall, if the temperature of the wall falls below the dew point temperature, it is quite normal for condensation to occur predominantly on the external walls.

When condensation occurs

Condensation occurs usually in winter, because the Caravan is cold and because skylights, windows and doors are opened less and therefore the moist air cannot escape.

How condensation occurs

Condensation occurs often for short periods in bathroom and kitchen areas because of the steamy atmosphere, and quite frequently for long periods in unheated areas; it also occurs in cupboards or corners of rooms where ventilation and movement of air is restricted.

What is important

Two things are particularly important:

- To provide ventilation so that moist air can escape.
- To use the heating reasonably

How can you prevent condensation

Provide ventilation so that moist air can escape.

- a) Good ventilation of kitchens when washing, cooking or drying damp clothes is essential. Use the electric element of the space heater will help, when washing, cooking, or drying damp clothes, and particularly when the windows show signs of misting up.
- b) If there is no mains electric supply and therefore you cannot use the electrical element of the space heater, open the skylights or windows slightly, but keep the door closed as much as possible.
- c) After showering, keep the bathroom window or skylights open, and shut the bathroom door long enough to dry off the room.
- d) In all other areas provide some ventilation. Fixed ventilation is provided in accordance with BS EN 721: 1998 this is through skylights and 'Heki roof lights' in the roofs and from ventilators through the floor under cookers, doors and in bed boxes it is important not to block these.

Too much ventilation in cold weather is uncomfortable and wastes heat. All that is needed is a very slightly opened window or skylights. Opening a skylight or 'Heki' rooflights partially or windows opened to about 1cm opening will usually be sufficient.

Provide reasonable heating

- a) Do not use of portable paraffin or flueless gas heaters at all.
- b) If drying damp clothes or towels, open a window enough to ventilate the area and turn on the electric element of the space heater but do not hang items over the heater.
- c) Try to make sure that all areas are at least partially heated. Condensation most often occurs in unheated areas.

EXTERIOR AND INTERIOR MAINTENANCE

- d) To prevent condensation, the heat has to keep room surfaces reasonably warm. It can take a long time for a cold caravan to warm up, so it is better to have a small amount of heat for a long period than a lot of heat for a short time.

Caravans use only carefully selected insulation materials but unlike most rooms at homes they have all outside walls, so they lose heat through all walls as well as the roof and floor.

Even in a well insulated Caravan with reasonable ventilation it is likely during cold weather if the temperature is less than 10°C that condensation will occur. Ideally the temperature should be kept about 20°C although this is not always possible.

Mould growth

Any sign of mould growth is an indication of the presence of moisture and if caused by condensation gives warning that heating or ventilation, may require improving.

New vehicles

New Caravans often take a long time before they are fully 'dried out' because of moisture in the materials used in the manufacture. While this is happening they need extra heat and ventilation. At least during the first winter trips and may require more heat than they will need in subsequent winters journeys. Allowance should be made for this.

WARNING: Do not wash your caravan with a high pressure washer as these can permanently damage the seals of your caravan.

Changing Exterior Bulbs

ALWAYS REPLACE LIKE FOR LIKE

For individual replacement bulb specification, refer to your Service Handbook.

CARAVAN INTERIOR

Follow these guidelines to ensure your investment is receiving the very best attention.

Side Walls, Roof Lining

A simple wipe over with a damp cloth and a very mild detergent is all that is needed.

Soft Furnishings

Should be vacuumed occasionally to remove grit and sand and help to keep its smart appearance and ensure long life. The upholstery can be cleaned with a mild, reputable upholstery cleaner. It is recommended that the curtains and pelmets are specialist cleaned only. The foam used in cushions is manufactured to meet fire regulations. It requires time to return to its normal position after prolonged use.

Work Surfaces

You should not stand very hot items on any of the work surfaces, especially models with polycarbonate moulded sinks and drainers.

Kitchen Equipment

All the thermoplastic parts in these areas have easy clean surfaces. To ensure long life and to prevent damage you must not use any cleaning materials at all and ensure water temperatures do not exceed 70°C (putting cold water in first is suggested). After every use it is essential that you rinse with clean water only and wipe with a soft damp cloth. Failure to follow these simple instructions may result in premature failure or cracking which will not be covered by any guarantees (including extended warranties).

Bathroom/Shower

These products should be cleaned immediately after use. Apply a warm, mild soapy water solution with a soft cloth and rinse with clean water immediately. Abrasive materials must never be used. For stubborn stains "Thetford Bathroom Cleaner" is recommended as the use of other cleaners may harm these products, cause premature failure and will invalidate the warranty. "Thetford Bathroom Cleaner" is available from most caravan dealer shops.

Furniture

A simple wipe over with a damp cloth should be all that is required. Polishing with a proprietary brand of wax polish enhances and maintains furniture in showroom condition.

It must be remembered that because the frames of the doors are made of ash, which is a natural product, they can be affected by temperature and humidity and may bow under certain conditions. As conditions change they should revert to their original positions.

Kitchen Drainer and Cutting Board

You should not stand hot items on to the removable plastic kitchen drainer. To wash use only warm soapy water, do not use chemicals and bleach.

Changing interior bulbs

Remove the lens or lampshade to access the bulb.

ALWAYS REPLACE LIKE FOR LIKE

For individual replacement bulb specification, refer to your Service Handbook.

Locker Header Fluorescent Tube Replacement

- Ensure power supply to light is switched off.
- Open locker, light is mounted above. Locate fixing screws (orientated towards ceiling) and remove.
- In the case of a side locker, a small furniture component onto which the light fitting is secured can now be removed.
- In the case of an upper welsch dresser (or similar), a larger component carrying all the lights from above that piece of furniture may detach.
- Once the appropriate light fitting has been accessed, the tube should be twisted along its length to release the tube and allow it to be lifted from the fitting.
- Please see the bulb replacement chart for details of the type of tube fitted. In addition, different 'colour temperatures' of bulb are available. For a consistent appearance replace tubes with those of equivalent colour temperature: This will be stated on the fitted tube in the format '4200K' or similar.

WINTERISATION

WINTERISATION

The Swift Group recommends the following winterisation points for customers:

Servicing

Arrange (in advance) the yearly service and habitation check, if the caravan's next service is due while the vehicle is stored.

Plumbing (where tank is fitted)

- Open the tank drain valve to drain the tank, and leave open.
- Open the safety drain valve (yellow handle) next to water heater, and leave open.
- Fully open all the taps and shower mixer, move mixer position to the middle, and leave all taps in the open position.
- Unscrew the shower head and shower hose, shake out remaining water and allow water to drain. It is advised to leave the shower head and hose disconnected.
- Run pump for a short time, until all water is expelled.
- Disconnect the inlet pipe to the onboard water pump, mesh filter and outlet pipe, and re-run the pump for a short time, to ensure all the water is removed. Leave the system disconnected during storage.
- Fit the cowl cover to the Truma Ultrastore (if fitted).
- Clean waste pipes and tanks using a sterilising fluid.

Electrical

If vehicle is being stored while connected to 230v Mains Hook-up:

- Ensure that the leisure battery is connected and the 20A local fuse(s) is connected.

- The isolator switch on PSU should be in the 'ON' position, however, the control panel should be switched 'OFF'.
- If Alde system is installed, there is a frost protection setting, which can be used.
- Vehicles can be left in this condition for extended periods, with the charger operating to maintain the battery. However, periodic maintenance and inspection is recommended, this should include the battery condition.

If vehicle is being stored not connected to 230v Mains Hook-up:

- Charge the leisure battery for 24 hours prior to placing caravan in storage.
- Ensure the isolation button on PSU is in the 'OFF' position.
- Ensure leisure battery is connected and 20A local fuse(s) is in place, if an alarm or tracker device is fitted.
- The alarm / tracking device will eventually drain the leisure battery - we recommend regular (monthly) inspection / re-charging of leisure battery via appropriate solar panel can be used to provide an alternative power source and extend the time between leisure battery requiring a re-charge.
- Remove the leisure battery and store in a dry place, if an alarm or tracker device is not fitted.
- The battery should not be adversely affected by winter temperatures but the level of charge should be maintained to maximise the life span of the battery. This can be achieved using an automotive type battery charger as and when required.

Gas system

- Ensure the gas supply is isolated at the gas bottle, and ensure that the gas manifold taps are off.
- Check the age and condition of the high pressure gas hose and regulator, and replace if required.

Appliances

Check the battery expiry date on the smoke alarm and replace or remove as required.

- Ensure the fridge is turned off.
- Clean the inside of the fridge.
- Prop the fridge door open, and if possible, the internal freezer compartment door for ventilation.
- Fit fridge vent winter covers (if available).
- Ensure all hob / oven / microwave surfaces are clean.
- If the caravan is going to be left connected to 230v supply while not in use, ensure the microwave is unplugged.
- Drain the toilet reservoir.
- Empty the toilet cassette.
- Leave toilet caps removed and apply acid-free Vaseline or similar to the seals.
- Drain the toilet reservoir.
- Empty the toilet cassette - The Thetford Cassette porta potti is easily winterised for storage.

Empty the fresh water tank using the drain tube / fresh water tank level indicator (level indicator on electronic models only).

Pull the lever indicator / drain tube down from top plug position and outward through door opening to drain water from the tank.

Empty the water fill funnel by pulling the bottle away from tank.

Remove the small water cap on the filler bottom, allowing water to drain from the water funnel. (Not C-200 toilet).

Do not tighten caps, this helps in keeping unit dry. The pour out spout and vent plug can be removed. Seals should be greased if necessary with acid-free Vaseline.

Exterior (Body / Chassis)

- Ensure that all windows, skylights and access doors are closed and secured.
- Ensure all fixed ventilation points (high and low) are clear from debris and obstructions.
- Ensure the vehicle is not parked where falling debris (i.e. leaves, tree sap) could cause damage.
- Avoid leaving the vehicle parked in soft ground, long grass or a potential area where standing water may form.
- Lubricate relevant points on the chassis.
- Remove road wheels, using the correct jacking points and suitable axle stands, or if being left on road wheels rotate wheels (every two weeks) and ensure the correct tyre pressures are maintained.
- A purpose made cover maybe used, but please ensure the cover is a good fit, breathable and securely fitted.
Note: A poorly fitted cover can rub and damage the bodywork. Non-breathable covers will encourage mould to grow.

Interior (Furniture / furnishings)

- Open all lockers and internal doors, to ensure good circulation.
- Remove cushions and store them in a dry location or ensure all cushions are placed in a well ventilated area.
- Close all blinds and curtains. Customers are reminded to check the tension on blinds after storage if left closed for long periods.
- Thoroughly ventilate the caravan by opening doors or windows periodically.
- Placing water absorbent crystals in the van during the winter months, will help reduce moisture levels and mould growth.
- We do not recommend leaving portable heaters in the van unattended.

WINTERISATION

Water system

Water expands as it is frozen, and so trapped water, when it expands, can damage the tap / valve / pump or pipe it is trapped within. For this reason, (in addition to reasons of hygiene), the water system should be fully drained when not in use, particularly in colder weather.

Follow the basic steps outlined below to remove water from the system (current caravans):

- Disconnect any external water source, external submersible hose or pump.
- Locate the 'Yellow' drain valve, which is floor mounted and will be next to the water heater. Move the lever on this valve to the vertical.
- If a water tank is fitted, open the tank drain valve located on the floor, next to the heater drain valve as above.
- Open one of the taps (the kitchen tap is the most convenient) to the middle (hot and cold mix) position.
- Turn on the pump using the button on the control panel, and leave the pump running until water no longer flows from the tap.
- Open the vanity tap and shower tap mixer, again to the centre hot and cold position and leave them open whilst the caravan is out of use.
- Also remove the shower head, and leave the head in an upright position.

After a short while the majority of water will have left the plumbing system. At this point however it is still important to ensure that the pump itself is 'dry'. During this part of the winterisation, a suitable absorbent cloth or container should be used to catch a small amount of spilled water that will result.

The pump should be disconnected on the output side of the pump, and run for a short while to expel any water contained within the pump body and filter. This is also a good time to dis-assemble and clean (if necessary) the filter fitted on the input side of the pump.

The easiest method of disconnecting the pump will vary depending on which manufacturers pump is fitted. The options are to unscrew the 'Beige' screw-fit adaptors from the pump inlet and outlet, remove the quick-release tabs from the Posi-flo type pump, or remove the 'Blue' pipe work from the push fit plumbing connections. (Details of releasing push fit plumbing connections can be found later in this document).

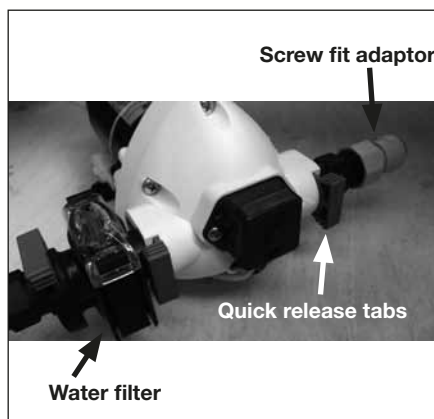

Galvanised Parts
- Wet storage stain (white rust)

Hot dip galvanising has been used for many years throughout the automotive industry and is widely regarded as one of the best forms of corrosion protection.

When the steel is withdrawn from the galvanising bath it has a clean, bright surface. Over a period of time this changes to a dull grey colour as the surface zinc reacts with oxygen, water and carbon dioxide in the atmosphere to form a tough, stable, protective layer.

During this time, if galvanised items are stored in damp or wet conditions, where there is little or no air movement then the zinc will continue to react with the moisture that is present. In so doing the zinc will produce excessive amounts of zinc hydroxide. This is seen as a bulky white deposit on the surface of the galvanising and is often referred to as wet storage stain (white rust).

In order to prevent the occurrence of wet storage stain in the first instance, and to allow the final protective layer to form correctly it is important to ensure that all galvanised parts are stored in good conditions, with sufficient ventilation to allow good air circulation.

In the case of caravans, you can help to prevent wet storage stain (white rust) occurring. You can do this by washing the chassis with clean water. You must then allow an adequate flow of dry air to ensure that they dry off completely.

The caravan should not be parked on long grass where the air flow around the chassis is hindered and the dampness retained. It is most likely that the chassis will rapidly show signs of wet storage stain under these conditions.

It is also very important to do this during the winter months to ensure all salt deposits from road spray are completely rinsed off.

AL-KO CHASSIS

Manufactured from high quality steel, the chassis has extra deep sections to provide strength at points of maximum stress. Large elongated holes are punched in the longitudinal chassis members, to reduce weight to a minimum. Each hole incorporates a return flange to maintain the required strength and provide rigidity in the extra deep sections.

The chassis frame is of a bolted construction which allows replacement of individual parts should the need arise.

The chassis is Hot Dipped Galvanised. This is regarded as one of the best forms of corrosion protection. It does however require minimal maintenance in certain circumstances and should, if properly maintained, last the lifetime of the vehicle.

When new, the chassis is of a bright and shiny appearance. As the galvanising cures during the initial 2/3 month period, this will gradually change to a medium/dark grey colour. This grey finish is the ideal, giving the correct protective coating. During this curing period the surface should be protected to avoid possible wet storage stain, in the form of a soft, light coloured, porous, oxidation layer. If the chassis members are in contact with any salt deposits from roads this should immediately be washed off with a high pressure washer. Salt attracts moisture allowing the surfaces to remain wet, this prevents curing and also allows formation of wet storage stain.

It is recommended that the chassis/ components are washed off, using a pressure washer on an annual basis (especially after winter usage), to avoid undesirable build up of salt and dirt deposits.

The galvanised chassis should not be painted or subjected to any other protective treatment.

Should the galvanising become superficially damaged exposing the steel core, this should be cleaned and treated with a Cold Galvanising Spray obtainable from vehicle accessory outlets.

Damage to chassis members through impact etc, MUST NOT be straightened or welded. Damaged chassis members MUST be replaced.

Drilling or Welding of Parts or Accessories

The chassis is designed and built to precise tolerances and must not be drilled or welded (except in accordance with certain AL-KO Accessory Operating Instructions). Failure to comply will invalidate all warranties.

AL-KO ATC TRAILER CONTROL SYSTEM

AL-KO ATC is an electronic, emergency Control system for caravans and trailers. It automatically recognises critical swinging motions and applies the caravan brakes accordingly to regain control of the caravan and car.

General notices

Read and act in accordance with the following operating instructions before attempting to use AL-KO ATC. AL-KO ATC is a safety related product and, therefore, should only be fitted by an authorised AL-KO trained technician with experience of working with electrical installations. Any evidence of removal or disassembly, other than by trained technicians, will immediately invalidate the product warranty.

Safety Information

AL-KO ATC is a passive safety product that activates the braking system on the caravan in unsafe driving conditions. The driver has a responsibility under law to ensure that the elements of towing safety are met, including driving within the legal speed limit, consideration of road, weather and other traffic conditions, correct loading and coupling of the caravan.

AL-KO ATC is designed to fit only on AL-KO Chassis and is not suitable for non AL-KO Chassis. AL-KO ATC only functions on caravans with a rigid towbar. The electrical connection between the towing vehicle and caravan must be in good working order.

System requirements

ATC draws power from the towing vehicle towbar and requires connection to either: Twin 7-Pin Connection - ATC can be connected via the auxiliary 12S (white/grey) plug and requires power on Pins 4 (permanent supply) and 3 (earth). Please ensure that your vehicle towbar is correctly connected to ensure correct ATC operation. This can be checked with the use of a multimeter. Important - A 20 amp fuse is required for the constant 12V supply to Pin 4 on the 12S socket. If only a single fuse is fitted to supply both Pins 4 and Pin 6, the power supply capability of the installation must be checked and a minimum fuse rating of 25 Amps must be used. 13 Pin Connection - ATC can be connected via the 13-Pin plug and requires power on Pins 9 (permanent supply) and 13 (earth). Please ensure that your vehicle towbar is correctly connected to ensure correct ATC operation. This can be checked with the use of a multimeter.

what to do in this case. Prior to commencing any journey, ensure that the caravan lighting is fully operational and check the vehicle is loaded appropriately, the nose weight and tyre pressures are correct, and confirm that the caravan is coupled to the vehicle with the breakaway cable correctly applied. Always re-check the ATC LED is green after any interval during a journey, such as a service station break.



ATC LED on fairing

Troubleshooting

Should you experience a fault with ATC, the LED light on the fairing will change colour. Therefore, refer to the table on page 4 and follow the instructions. If no illumination of the LED is evident, refer to system requirements on page 3 and check towbar wiring for permanent supply.

In the unlikely event that you receive a red flashing LED light and disconnecting and re-connecting the power does not alleviate the problem, check the push rod position as detailed below. Locate ATC on the axle and check the position of the push rod. If no red line is visible, ATC is not active, and can be driven. However, we recommend that you contact AL-KO at the earliest convenience.

If the red line is visible on the push rod, as shown on the left, the caravan should not be moved. The push rod needs to be removed to deactivate ATC. Using two 17mm spanners, the removal process is as shown opposite.



Operating instructions

After coupling the caravan correctly to the towing vehicle, connect the 12N & 12S plugs or the 13 Pin plug to the towbar.

Upon connection, ATC will carry out an initial self test and the LED light on the front fairing will light up RED. During the self test, the sound of the push rod moving inside ATC can be heard. When the self test is complete, the LED will turn GREEN or flashing GREEN to signal that ATC is active. If the LED does not change to green, then ATC is not functioning correctly. The table provided on page 4 details

AL-KO ATC CONTROL SYSTEM

Display Colour	ATC Condition	Diagnosis	What to do	Outcome	Status
Green	ATC Active	Everything Ok			
Green Flashing	ATC Active	Self test incomplete	Drive forward to detect movement to complete self test and recheck LED.	Green (Constant)	Ready for journey
Red	ATC Inactive	Possible to continue journey	Remove 12S or 13 Pin plug and wait 5 seconds. Reconnect plug.	Green	Ready for journey
				Red	ATC Error logfile memory exceeded. Caravan can be towed, but ATC will not apply caravan brakes in the event of instability. See below *
Red flashing	ATC has detected a fault.	Do not continue a fault with ATC connected	Remove 12S or 13 Pin plug and wait 5 seconds. Reconnect the plug	Green Red (flashing)	Ready for journey ATC faulty, and cannot be driven. Remove push-rod as shown on page 5. Consult AL-KO, see back page for details.
LED not working	ATC has no power	Check push rod position as shown LED faulty on page 5 before continuing journey.	Remove 12S or 13 Pin plug and wait 5 seconds. Reconnect the plug. Check for constant live - refer to system requirements.	Green LED not working	Ready for journey If power ok, check push rod position: Red line visible - do not drive vehicle. Red line not visible - possible to continue journey but consult AL-KO see back page for details.

* ATC stores operating errors in a logfile which over time will become full and will result in the solid red light appearing. This needs to be erased and can be done easily by connecting the caravan to a 12 volt supply for a period of 12 hours. The power required to carry out this function is minimal. Most occurrences of these errors are due to power supply problems to ATC which could be due to low voltage, or an intermittent power supply from the towbar.

Maintenance and Warranty

ATC is maintenance free and requires no servicing. In case of any damage to ATC, please contact AL-KO. ATC is a sealed unit and any evidence of removal of ATC or the component parts including outer casing and fixings will immediately invalidate any product warranty.

ATC is covered by a 12 month warranty where it is retrofitted to a caravan. If ATC is fitted as standard by the vehicle manufacturer then ATC is covered for the same duration of the vehicle warranty or whichever is longer. If ATC is subject to a call out under warranty and found to comply with the relevant specification or standard, then the cost of any testing or callout charges will be borne by the customer. We reserve the right to request credit card details to cover payment in advance.

Removal of a push rod



Using a 17mm spanner, slacken locking nut on push rod away from Bowden cable abutment as directed above.



Unscrew push rod from brake rod and slide it from the guide tube. Remove the locking nut from push rod using two 17mm spanners.



Re-apply the removed locking nut onto brake rod thread to secure ball nut as shown above. ATC is now deactivated.

The AL-KO formula optimum safety

The AL-KO formula for optimum safety is a combination of industry leading technology that ensures the safest possible driving conditions for caravan owners. The formula provides total confidence and control when towing a caravan.



ATC

+



AKS

+



Responsible Driving

As an emergency system, AL-KO ATC automatically safeguards against a number of critical driving conditions. When used in conjunction with AL-KO AKS, there is no safer package for towing a caravan.

The AL-KO AKS Stabiliser device permanently suppresses small swinging and pitching movements in the trailer and increases the critical driving speed by approx 20%.

A safe driving style and correct loading combine with AL-KO technology to ensure optimum safety and unparalleled towing stability.

Loadings on Coupling Heads, Overrun Assemblies and Axles

The permitted 'nose' weights of the coupling head/stabiliser, overrun assembly and drawbars, must never exceed the lowest value stamped on the assemblies.

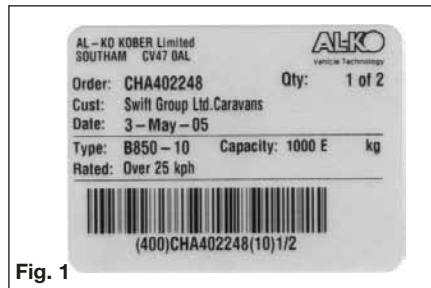

Fig. 1

The maximum axle loading is that stamped on the plate (Fig. 1 example axle plate) located in the centre of the axle, facing rearwards.

Do not attempt to remove as this will void the plate.

The third line down marked "Capacity" is the maximum permitted axle loading and must not be exceeded.

The caravan manufacturer may have stated a

lower maximum loading weight on the plate fitted adjacent to the entrance door, this then becomes the maximum permitted load and must not be exceeded. We recommend you record the Axle details for future reference.

It may be possible if required for the caravans MTPLM to be upgraded.

Your caravan dealer will require the following details from the axle plate.

(Example of information ref Fig 1)

- Order - CHA402248
- Qty - 1 of 2
- Date - 3 May 05
- Type - B850-10
- Capacity - 1000E

Please consult your Swift Group Dealer to confirm if this is possible.

Loading

Loads to be carried in the caravan should be placed directly over, or as close as possible to the axles, otherwise the handling will be impaired. Maximum gross weight, as advised by the caravan manufacturer, must not be exceeded without approval from AL-KO.

Maximum loading is defined as the difference between ex-works weight and the permitted total weight.

Load Too Far Forward (Fig 2)

Steering and braking ability reduced. Increased loading on the rear axle and chassis of the tow vehicle.

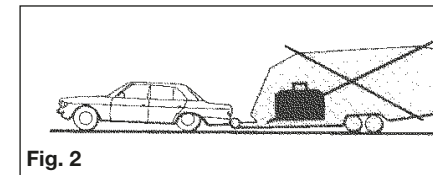

Fig. 2

Load Too Far Back (Fig. 3)

High skid risk together with poor braking effect.

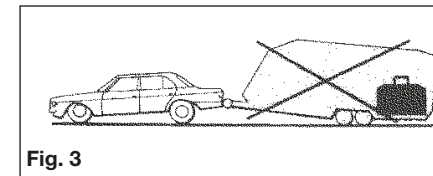

Fig. 3

Load Over Axle (Fig 4)

Optimum road holding together with maximum braking effect. Exceptionally heavy loads should be placed directly over the axle.

Attention should be paid to the legal regulations regarding the permitted pressure exerted by the towbar on the towed unit.

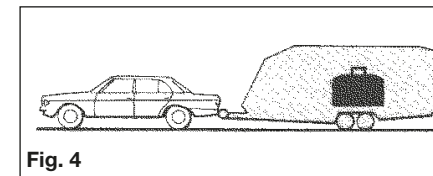

Fig. 4

AXLE TYPES

Safety Precautions

No welding is permitted on AL-KO Axles

It is important that the wheel and hub/ brake drum are compatible. This means that the PCD, wheelbolts and inset must all be compatible with both the hub/brake drum and the wheel rim.

Particular attention must be paid to the recommended torque figures for the wheelbolts (see pg 31).

The axle type details shown on axle type plates must not be obscured or made illegible by application of any additional surface finish.

OPERATING INSTRUCTIONS

Service Brake

When the towing vehicle is braking or travelling down hill, the overrun device shaft is pushed in (dependent on the magnitude of the thrust on the shaft) and presses on the overrun lever. This acts on the bowden cables and expander mechanism, which in turn expands the brake shoes applying the wheel brakes.

Hand brake

With the gas strut version, pull the handbrake lever until upright. With the spring cylinder version, pull the handbrake lever right up to the last tooth. The caravan is then braked.

IMPORTANT NOTE

Please note that with the handbrake fully applied, the caravan/trailer is able to move backwards by 25 cms until the spring cylinder/gas spring takes effect.

Maintenance and Cleaning

Maintenance of Euro-Plus/Euro-Compact and Euro-Delta.

The above semi-trailing axles come fitted with maintenance free wheel bearings (greased and sealed for life) and no adjustment is necessary.

Note: The hub bearing is not protected against water ingress. Check wheel brake

linings for wear every 10,000 kilometers (6200 miles) or every 12 months via the inspection hole

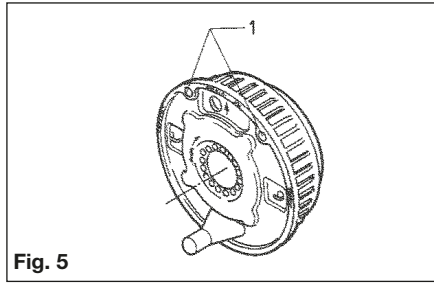

(Fig. 5/Item 1). Adjust if necessary. Where continuous travel in hilly regions or high mileage is experienced, earlier inspection and adjustment may be necessary.

NOTE: The flanged hub-nut, located under the dust cap, used to keep the brake drum in situ, is a ONE-SHOT NUT (ie. must only be used once). If removed it must be replaced with a NEW flanged nut - torqued to 290 ± 10 Nm (214 ± 7.5 lbs/ft). A small amount of special mineral grease, available from AL-KO must be applied to stub axle thread prior to fitting the new flanged nut. After fitting excess grease must be removed with white spirit.

The rear hexagon cap head bolt located under the black plastic cap **MUST NOT BE DISTURBED** under any circumstance. Interference with this nut will result in immediate tyre wear and damage to the braking system and **WILL INVALIDATE ALL WARRANTIES**. Should the rear nut accidentally be disturbed then the complete axle must be returned to AL-KO for resetting of the toe-in and camber.

No attempt should be made to remove the bearing. In the event of damage to the bearing or drum, only the drum complete with bearing and circlip will be available as a spare. No grease is used in the hub other than the mineral grease on the stub axle. No grease should be placed in the DUST cap. This is not a grease cap as used in all previous hubs

Spare parts

Spare parts are safety critical parts! For this reason when fitting spare parts we recommend the use of original AL-KO parts or those parts that they have explicitly approved. The reliability, safety and suitability of parts designed especially for their products, has been determined using a special test procedure. In spite of constantly monitoring the market they are unable to assess or vouch for other products.

If repair work or servicing is required, AL-KO have a large network of AL-KO service stations throughout Europe.

To establish the correct spare parts required for your axle you should always quote the axle type (axle identification plate Fig. 1, page 172) and Spare Part Identification no. (ETI No.), which will be stamped onto the wheel brake or on the identification plate (Fig. 6). Please establish these numbers before contacting AL-KO or a Service Agent.

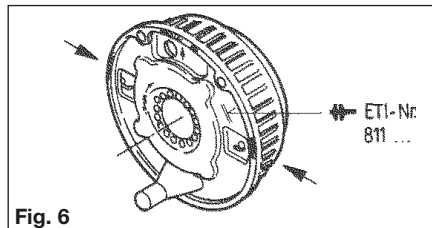

The AL-KO rubber suspension axle has been designed and developed to suit all types of road conditions and is maintenance free.

Three rubber elements are contained within an hexagonal axle tube. These provide suspension and have inherent damping characteristics.

Figs. 7, 8 & 9 show the deformation of the rubber elements at the extremes of suspension movement.

The axle is designed to ride with the suspension drop arm at, or slightly below, the horizontal position.

For Trouble Shooting & Fault Finding please see Table 1 on page 186-187.

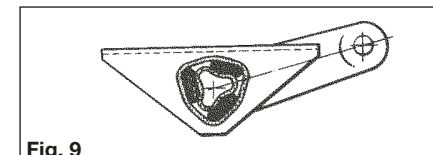
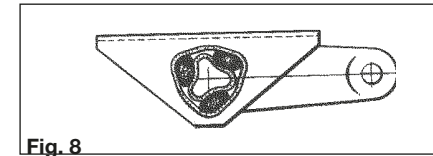
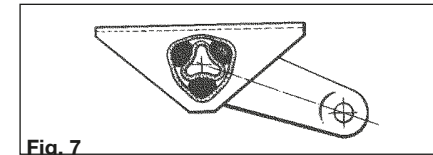

AL-KO braking system adjustment

1. Ensure the towing shaft with coupling head is pulled FULLY FORWARD. (Fig. 10).
2. Release the handbrake to the FULLY OFF position. If the handbrake will not go down the whole way because of the fairing or any other obstruction; then the fairing must be cut away and/or the obstruction removed to achieve this desired position. It will not be possible to set up the braking system properly when the handbrake is not in the FULLY OFF position. (Fig. 10).
3. Jack up one side of the caravan, using the AL-KO Side Lift Jack System. (see Jack Operating Instructions).
4. Remove the inner plastic bung from the backplate to expose the "starwheel" adjuster access. (Figs. 10 & 11).
5. ALWAYS rotating the road wheel in the forward direction - NEVER backwards; adjust the starwheel with a suitable screwdriver, in the direction of the arrow embossed on the backplate until there is resistance in the wheel rotation. (Fig. 11).

6. Slacken off the starwheel adjuster until the road wheel turns freely in the FORWARD direction. (Fig. 11).

7. Check the adjustment at the end of the brake cable where it is secured to the abutment (bracket), welded to the centre of the axle.

When the inner cable is pulled out it should extend between 5 and 8 mm. (Fig.12). (On tandem axles a double abutment (bracket) is fitted to the front axle ONLY).

8. Repeat for other wheel or wheels.
9. On tandem axles the brake cables from the rear axle should pass over this axle and cross over each other, before being connected to the abutment (bracket) on the front axle.
10. Ensure the balance bar (compensator) is being pulled evenly (Figs.10 & 12). Excessive movement to this bar (double on tandem axles) would indicate possible incorrect adjustment (if appropriate, repeat step No. 7 - Fig. 12).

11. Check the brake rod support bracket, (fixed to the floor) IS supporting the brake rod evenly. The brake rod **MUST ALWAYS** run straight, NEVER bent or curved under any fittings. On tandem axles, using the double balance bar, a brake rod support tube (ALKO Part No. 228827) **MUST ALWAYS** be fitted on the end of the brake rod, passing through the centre aperture on the abutment.

12. Remove the slack in the brake rod by adjusting the long ball nut, rear of the balance bar, ensuring the overrun lever makes contact with the end of the towing shaft. Note! Over adjustment to the long ball nut (Fig. 12/Item 2) could induce movement of the inner brake cable, reducing the effective clearance of the brake shoes. If the overrun lever will not make contact, it is possible the two lock nuts, forward of the spring cylinder, are incorrectly adjusted. Loosen the nuts and adjust brake rod as above (Figs. 10 & 12).

13. Adjust the two locking nuts, forward of the spring cylinder (Fig. 10), (on some chassis a single Nyloc nut is used) to give 1 mm of clearance on the spring cylinder. This cylinder (the energy store for the handbrake operation) must be able to rotate ONLY, not slide on the brake rod. (Fig. 12). **(If the overrun assembly is fitted with a gas strut handbrake then no spring cylinder is fitted - therefore ignore this paragraph).**
14. CORRECT ADJUSTMENT of the linkage is checked by operating the handbrake lever so that when the second or third tooth is engaged, a slight braking force is felt on the road wheels.
15. OVER ADJUSTMENT of either the wheel brakes or linkages, will result in difficult reversing causing the wheels to "lock-up".
16. When parking, the handbrake lever MUST ALWAYS be engaged into the fully upright position (90°). This is to compress the spring within the spring cylinder and thereby create an energy store which will automatically engage the brakes further should the caravan move. If difficulty is experienced in this operation, try easing the caravan backwards with one hand while engaging the handbrake fully with the other. This manoeuvre should not be attempted on a rearwards facing slope. In this case wheel chocks should be used combined with the handbrake. See page 25 for all handbrake operations.
17. Finally, if the road wheels have been removed, re-tighten using a calibrated Torque Wrench to 88 Nm (65 lbs/ft) - on all M12 wheel bolts and steel wheels or 96lbs/ft (130nm) for alloy wheels. Remember to over-tighten is just as dangerous as to under-tighten, as this can distort the wheel rims. Avoid the use of power wrenches.

IMPORTANT - The torque settings should be rechecked regularly. Wheel bolts should NEVER be lubricated.

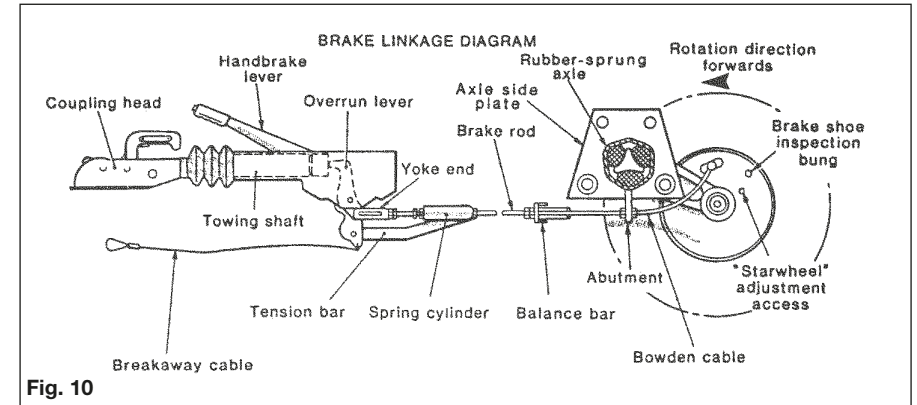

Fig. 10

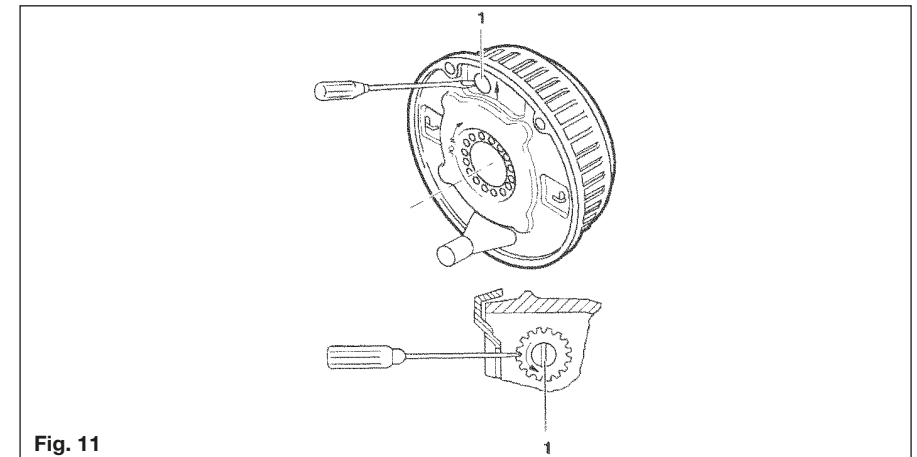

Fig. 11

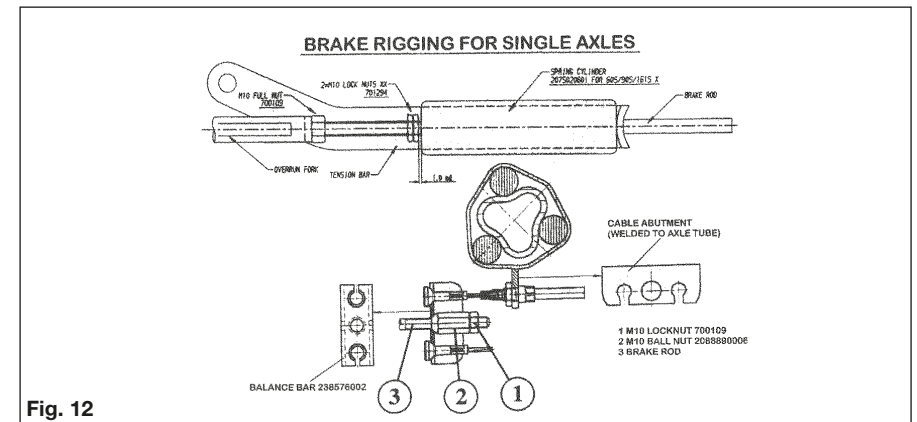

Fig. 12

OPERATING INSTRUCTIONS FOR AKS 3004

Regulations

1. The AKS 3004 must be used in conjunction with 50 mm dia. towballs which conform to EC Directive 94/20 (DIN 74058 or local equivalent).
2. Suitable for attachment to drawbars or approved overrun braking equipment for single (and tandem axle) caravan/trailers, with a minimum weight of 200 Kg and a maximum permissible weight of 2000 Kg.
3. EC design approval has been given to the AL-KO AKS 3004 coupling under permit No. e1*94/20*0930*00.

Restrictions of use

1. The trailer coupling may only be connected to towing vehicles where the clearances for the stabiliser can be observed, in accordance with EC Directive 94/20 (DIN 74058). If these clearances are infringed by special attachments, then the use must be checked separately.

Clearances for Stabiliser Handle (Fig. 19)

The area above the towball of the vehicle must be free from vehicle components or attachments (A) (eg. spare wheels, platforms etc.)

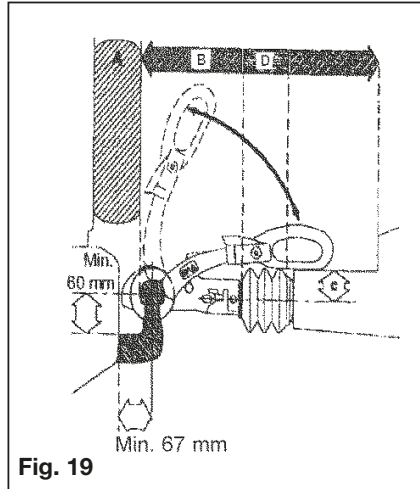

Fig. 19

The clearance for the stabiliser handle must be at least 330 mm (B) + the stroke movement (D) (85mm-100mm), which equates to 440 mm when used in conjunction with an AL-KO overrun.

Max. 50 mm (C) clearance between the centre of the towball and top of the overrun assembly or fairing, to ensure both coupling handle and stabiliser handle do not foul on operation.

Maintain the same clearances for other manufacturers' overrun assemblies.

2. Not suitable for use with overrun devices which can revolve above 25° (Fig. 20).
3. Swan Neck towbars (fixed or detachable) are suitable for use with the AKS 3004 providing they comply to EC Directive 94/20 and have the required minimum 60 mm clearance, measured from the centre of the towball (Fig. 20).

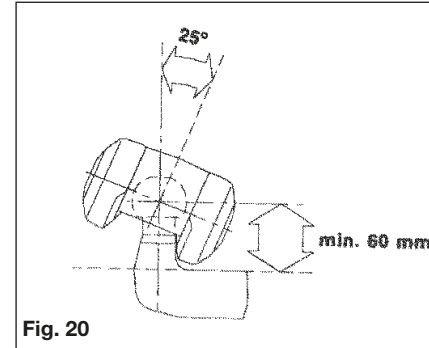

Fig. 20

Safety warnings

1. In accordance with EC Directive 94/20, couplings of type A 50-1 cannot be used (see Fig. 21), your warranty will be invalid if this type of towball is used.
2. For UK use, please use the extended neck towball (type A50-X).
3. A bolted-in type ball coupling (Fig. 22) is only permissible if the thread is locked or welded.

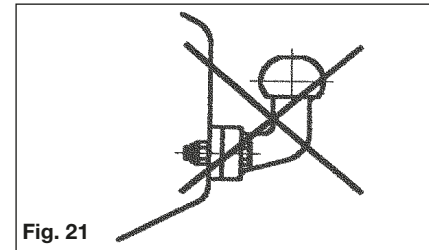

Fig. 21

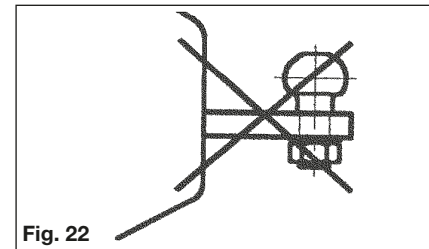

Fig. 22

4. The AKS 3004 cannot be used with a laterally attached reversing lever, on the left side, when facing direction of traffic.
5. The towball must be free from grease, paint and other residue, otherwise the stabilising effect will be greatly reduced.
6. If friction pads become contaminated with grease, they should be replaced.
7. The AKS 3004 should only be operated by one person, when opening or closing the handle, to reduce injury risks.

AKS 3004 DELIVERY SPECIFICATIONS

Coupling handle (Fig. 23/Item 1),
Stabiliser Lever (Fig. 23/Item 2)

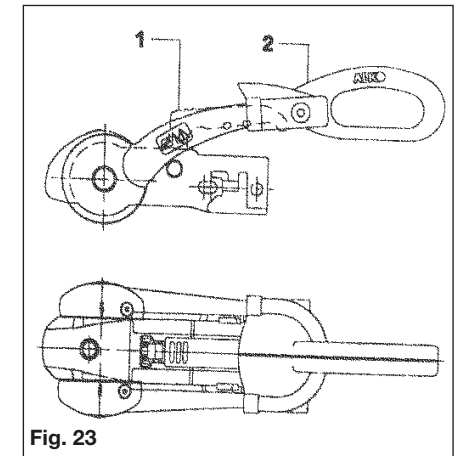

Fig. 23

Preparation for coupling/uncoupling

The Stabiliser lever (Fig. 24/Item 2) must be in the uppermost position (open).

HITCH

Coupling

Pull the coupling handle (Fig. 25/Item 1) up in the direction of arrow. The coupling mechanism has an open position ie. as long as the AKS 3004 is not placed on the ball, the handle will remain open. Put the opened coupling onto the clean towball. The handle must now make an audible click and return to the flat position.

Coupling Up (Euro-Overrun Devices)

Fully retract Jockey Wheel inner tube so that it locks against Jockey Wheel outer tube.

Slacken Jockey Wheel Clamp handle and raise complete assembly through cutout in body to its highest position (ensure it doesn't come into contact with the brake rod assembly), fully tighten Jockey Wheel Clamp handle to ensure the Jockey Wheel is firmly held in position.

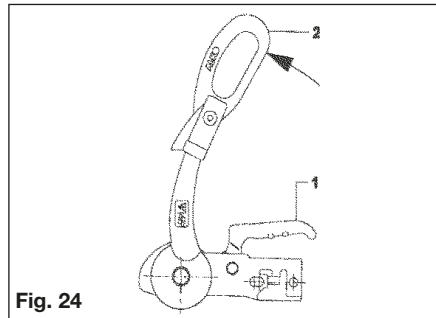

Fig. 24

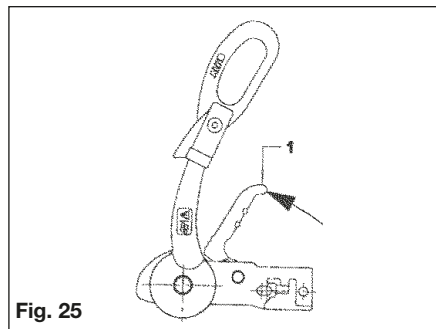

Fig. 25

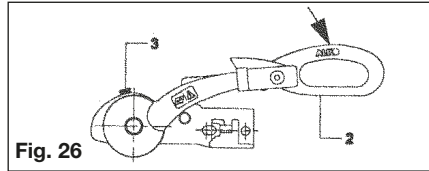

Fig. 26

WARNING: The coupling is correctly engaged when the green edge of the safety indicator button is visible or pops out (Fig. 26/Item 3).

Stabiliser Unit

To operate the Stabiliser (once coupled to the towball), simply press the stabiliser lever down as far as it will go (Fig. 26/Item 2).

Uncoupling

Pull the stabiliser lever handle up as far as it will go, open the coupling handle and lift the AKS 3004 from the towball. With larger nose loads, coupling and uncoupling can be made easier by using the jockey wheel to assist lifting.

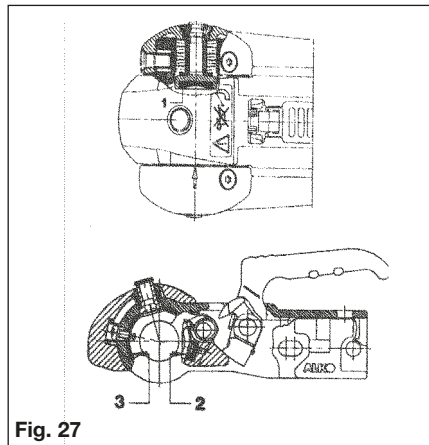

Fig. 27

Please Note: The friction pads (Fig. 27/1,2,3) are pressed against the towball and hence generate a stabilising/damping force. These pads are therefore subject to wear over time, however they will have a long service life (circa.30,000 Miles), provided they are well maintained and kept free of grease/dirt.

Checking the efficiency of the left/right friction pads

1. Couple up AKS 3004.
2. Open Stabiliser lever (Fig. 28/Item1).
3. Close Stabiliser lever until resistance is felt (ie friction pads are in contact with the ball but not yet under pressure).

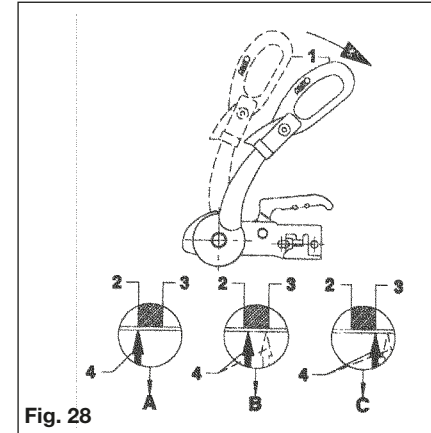

Fig. 28

4. If the arrow on the arm (Fig. 28/Item 4) is before or on the marked area (Fig. 28/Item 2) the friction pads are still as new (See A)
5. The arrow on the arm should lie between the marked area on the soft dock (See B)
6. If the arrow on the plate reaches or passes the marked area on the soft dock then the friction pads need replacing (See C).

Please Note: It is not necessary to adjust the friction pads

Manoeuvring

For easier manoeuvring (on campsites etc), pull the stabiliser lever to the 'up' position.

Please do not use the stabiliser lever as a manoeuvring handle. Please use the handles on the Caravan or fit the AL-KO manoeuvring handle to your jockey wheel (available separately).

1. During opening or closing, the AKS must only be operated by one person.
2. Press stabiliser lever down by hand force only DO NOT use your foot or an extension bar, this will damage the components (Fig. 29).
3. When opening or closing the stabiliser lever, please ensure your hand does not touch the coupling handle - you may accidentally trap your fingers! (Fig. 29).

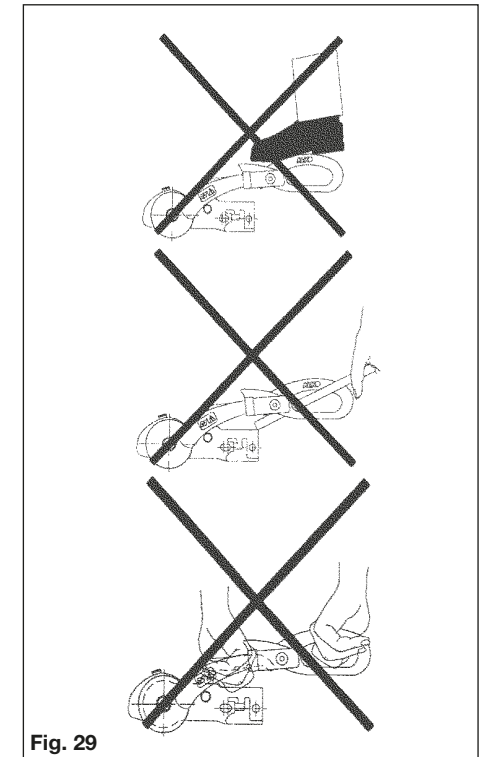

Fig. 29

HITCH

Noises whilst driving

As a rule, the friction pads of the AKS 3004 do not make a noise during driving. Any clicking, creaking or squeaking noises that do arise may be due to the following:

- Foreign bodies or dirt between the friction pad and tow ball.
- Dry operation of the draw shaft inside the overrun device.
- A detachable towball which has too much play in the locking mechanism.

Remedial Action

- Clean the tow ball and friction pads by lightly rubbing the surface (100-120 grit emery paper).

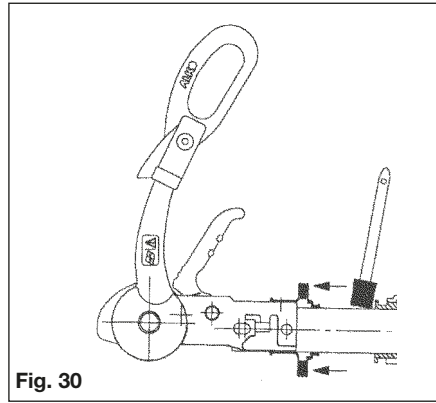

Fig. 30

- Lubricate the draw shaft sleeve via the grease nipples. In addition, push the gaiter forward and grease (DIN 51 825 KTA 3K) the exposed part of the shaft (Fig. 30).
- Visit a specialist workshop to have the ball holding area checked for damage and the locking mechanism for function. If necessary, change the towball.

Servicing and Cleaning

Friction Pad Replacement (please replace one at a time)

- Uncouple AKS 3004.
- Remove protective caps (Fig. 31/Item 1) with the aid of a small screwdriver.

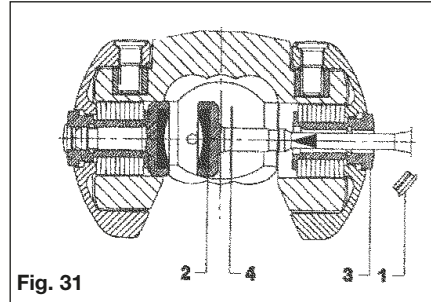

Fig. 31

- Press worn out pad inwards and remove (use punch and hammer) (Fig. 31/2)
- Insert new friction pad from below (after first re-inserting shim washers if they were present) and press in as far as it will go (Fig. 31/Item 4 & Fig. 32).



Fig. 32

Checking the efficiency of the front/rear friction pads

- Couple the AKS 3004 to the towball but do not activate the stabiliser.
- If a green indicator is visible (on the handle), then the AKS 3004 is in a new condition or the pads and towball are within the permissible limits (Fig. 33/Item 2).
- If only a red indicator is visible (Fig. 34/Item 3), then this may have the following causes:

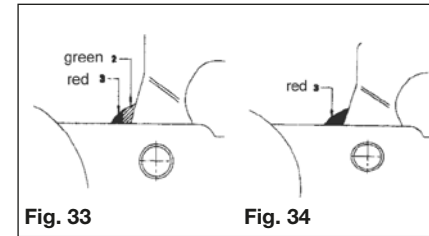

Fig. 33

Fig. 34

- AKS 3004 is okay but the towball has reached the lowest limit of 49.61mm
- AKS 3004 shows signs of wear
- Towball is in a new condition (50mm) but the front/rear friction pads show a high degree of wear.

Establish the diameter of the towball so that conclusions may be drawn as to the wear of the friction pads (ball diameter must not be less than 49.61mm)

Friction Pad Replacement (Front/Rear only)

- Uncouple the AKS 3004
- Remove the rubber soft dock (pull up and off) Fig. 35/Item 1 & Fig 36.

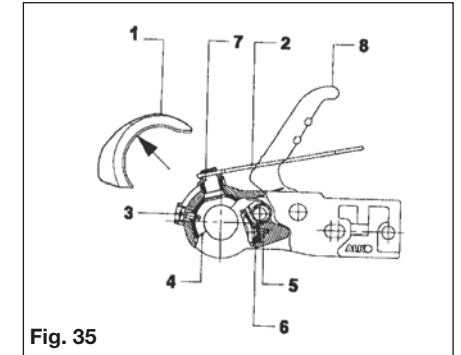

Fig. 35

- Press the safety indicator outwards and secure with SW14 hex. spanner (not included), (Fig. 35/Item 2).
- Remove cheese-head screws (Fig. 35/item 3 & Fig 36), using special torx tool.

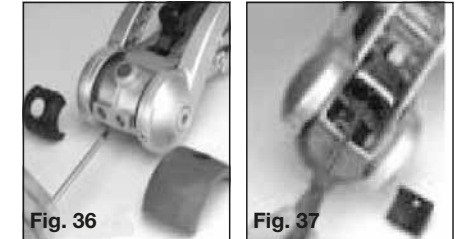

Fig. 36

Fig. 37

- Press friction lining recess (Fig. 35/Item 4) inwards and pull down and out.
- Open coupling handle (Fig. 35/Item 8).
- Remove countersunk head cap screw using special torx tool (Fig. 35/Item 5 & Fig. 37).
- Press friction pad inwards with a screwdriver and remove from ball cup.
- Fitment of new linings takes place in reverse. Tighten screws 3 & 5 to 5 Nm.
- Replace rubber soft dock, insert top section first then bottom.

Important Maintenance and Cleaning Advice:

1. The towball should be cleaned regularly to remove grease or other residue, the use of Thinners, White Spirit or Brake Cleaner is recommended - otherwise the stabilising effect will be severely reduced.
2. If friction pads are contaminated, they should not be cleaned but replaced.
3. The surface of the towball must be free of grooves, rust or seizing marks.
4. Towballs coated (with paint or similar) must have this surface completely removed (use 100 or 120 grain emery paper). If this is not done, increased towball wear will occur and may cause damage to the AKS 3004 components.
5. In Winter, carefully spray only the visual indicator with de-icer.

Lubrication

Should lubrication of the stabiliser parts become necessary, then the following must be observed.

- a) Clean all parts thoroughly.
- b) Areas may only be covered with a thin film of grease (Fig. 38).

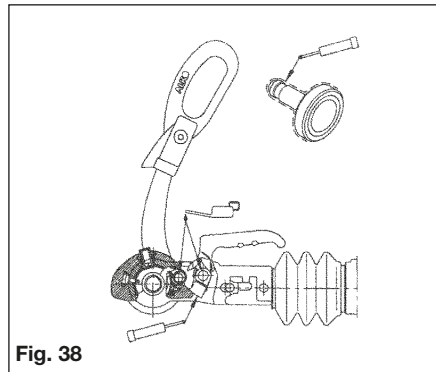

Fig. 38

- c) Use multipurpose grease DIN 51825 KTA 3K.

WARNING: When lubricating, ensure none gets into the friction pad or towball holding area.

AL-KO secure immobiliser (model specific)

Refer to the User Instructions Kit supplied.

Overrun Devices

In the importance of Safety, please familiarise yourself with the operation of this overrun device BEFORE using your caravan/trailer.

Safety Precautions

When parking your tow vehicle and caravan/trailer on site, you must apply the caravan handbrake. If the unit is parked but disconnected from the tow vehicle, it is strongly recommended that each wheel is chocked using AL-KO or suitable wheel chocks.

If a 'detachable' type drawbar is fitted (as with catering trailers), the drawbar must not be removed from the trailer with the hand-brake applied.

Caution: Please note when parking the caravan/ trailer, the wheelbrake auto-reverse mechanism will allow the caravan/trailer to travel backwards for approximately 25 cm (please allow sufficient clearance when parking).

Operation

AL-KO overrun devices are a mechanical type, using a hydraulic damper.

Coupling Up

Manoeuvre towing vehicle or trailer to coupling point.

Overrun devices fitted with 50 mm coupling head

Fully open coupling head handle and secure hitch onto the towball. See page 25 (coupling up).

Thread the breakaway cable through the breakaway cable guide provided (Fig. 40) and connect it to attachment point provided on towing bracket (Fig. 39). Please refer to 'Braked Trailers Use of Breakaway Cables' for further detail.

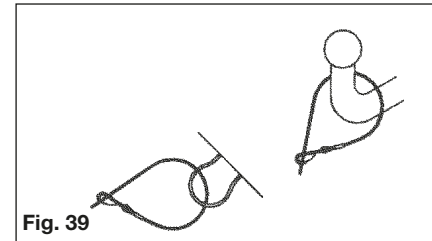

Fig. 39

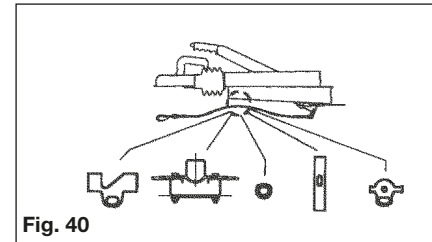

Fig. 40

Caution: The breakaway cable operates the handbrake (emergency brake), in the event of the caravan/trailer becoming detached from the towing vehicle during towing. For this emergency brake to work correctly, it is absolutely essential that the following points are observed:

1. The breakaway cable MUST run through the breakaway cable guide.
2. The breakaway cable MUST NOT be wrapped around the jockey wheel, as this disables the emergency brake (Fig. 41).

3. The cable MUST run as straight as possible and not be restricted.
 4. Ensure the cable is long enough to allow for cornering and will not become taut or snag during use, as this could result in the handbrake operating whilst towing.
- Please refer to 'Braked Trailers Use of Breakaway Cables' Information sheet, supplied with your caravan/trailer.

TROUBLE SHOOTING & FAULT FINDING

Table 1 Axles

Fault	Cause	Remedy
Poor Braking	Linings worn or damaged. Brake Linings not bedded in. Brake set up incorrect.	Replace Brake Linings. Will pass after braking a few times. Reset Brakes as page 175 & ensure system is lubricated.
Difficulty in Reversing	Braking system set too tightly. Auto-Reverse lever too stiff.	Reset Brakes as page 175. Lubricate and free off Reverse Lever.
Brakes Overheating	Incorrect setting. Braking system not fully released. Overrun lever stuck. Damage or Corrosion to braking system	Reset Brakes as page 175. Check Handbrake has been released & the system is running freely. Lubricate and free off Reverse Lever. Check system as page 175 and repair or renew parts as necessary.
Handbrake Force Low	Incorrect setting of the brakes. Linings not bedded in.	Reset brakes as page 175 and lubricate as necessary. Will pass after braking a few times.
Uncomfortable ride or Uneven Braking	Loose braking adjustment. Damper defective. Axle shock absorbers defective.	Reset brakes as page 175. Check and replace damper if necessary. Replace shock absorber.

TROUBLE SHOOTING & FAULT FINDING

Table 1 Axles

Fault	Cause	Remedy
Poor Braking	Linings worn or damaged. Brake Linings not bedded in. Brake set up incorrect.	Replace Brake Linings. Will pass after braking a few times. Reset Brakes as page 175 & ensure system is lubricated.
Difficulty in Reversing	Braking system set too tightly. Auto-Reverse lever too stiff.	Reset Brakes as page 175. Lubricate and free off Reverse Lever.
Brakes Overheating	Incorrect setting. Braking system not fully released. Overrun lever stuck. Damage or Corrosion to braking system	Reset Brakes as page 175. Check Handbrake has been released & the system is running freely. Lubricate and free off Reverse Lever. Check system as page 175 and repair or renew parts as necessary.
Handbrake Force Low	Incorrect setting of the brakes. Linings not bedded in.	Reset brakes as page 175 and lubricate as necessary. Will pass after braking a few times.
Uncomfortable ride or Uneven Braking	Loose braking adjustment. Damper defective. Axle shock absorbers defective.	Reset brakes as page 175. Check and replace damper if necessary. Replace shock absorber.

CHASSIS TROUBLE SHOOTING

Table 2 Coupling Heads

Fault	Cause	Remedy
Coupling does not engage onto ball	Ball diameter too large. Ball could be damaged or deformed. Coupling head dirty or defective.	Change ball to correct size. Fit new ball. Clean & Lubricate coupling and replace if necessary.
Difficulty in Uncoupling	Ball damaged or deformed. Coupling damaged or deformed. Coupling head under pressure from damper.	Fit new ball. Replace if necessary. Pull forward a few inches to relieve pressure
Too much play in the coupling	Coupling damaged or deformed Ball too small	Replace if necessary. Fit new ball.

Table 3 Overrun Devices

Fault	Cause	Remedy
Poor Braking	Overrun shaft tight. Overrun shaft corroded. Body housing damaged.	Lubricate overrun shaft and replace any damaged parts.
Brakes Overheating During Towing	Handbrake not fully released. Braking system incorrectly set. Incorrect attachment of breakaway cable.	Release handbrake. Reset brakes as page 175. Ensure correct attachment as listed on page 22 or refer to Braked Trailers Use of Breakaway Cables sheet.
Handbrake Force Low	Defective gas strut. Incorrect setting of spring cylinder.	Replace gas strut. Reset spring cylinder as page 175.
Brakes Apply During Deceleration or Downhill Travel.	Overrun damper is defective.	Replace the overrun damper.

CHASSIS ACCESSORIES

ACCESSORIES

Corner Steadies

Corner Steadies are as stated, for the purpose of steadying the caravan corners. They are NOT JACKS AND SHOULD NEVER BE USED AS SUCH. The screw and pivot pins should be lubricated periodically to ensure their satisfactory operation. (See also Jack Operation).

Shock Absorbers

All AL-KO chassis have pre-punched holes to accommodate Shock Absorbers, in front of the axle. On the Euro-Axle System, axle swing arms have a removable rectangular plastic cap exposing a slot to accommodate retro-fit brackets for the Octagon Shock Absorbers. Delta Axles have Shock Absorbers fitted as standard which MUST NOT BE REMOVED.

Road Wheels

In most instances the road wheels and tyres are supplied by the Caravan Manufacturer. The condition of wheels and tyres should be checked regularly, particularly for distortion of flanges and the wheel dish. Wheels that are damaged or distorted, or have wheel bolt seatings cracked or deformed must not be repaired or used in service - these must be replaced.

Important: Standard AL-KO caravan chassis use M12 wheel bolts. These must always only be tightened to the correct torque setting:

- Steel wheels 88 Nm (65 lbs/ft)
- Alloy wheels 130 Nm (96 lbs/ft)

in sequence, (i.e. North, South, East, West); NEVER clock or anti-clockwise. ALWAYS use a calibrated torque wrench, do not use a corner steady brace, power or electric wrench. It is as dangerous to overtighten wheel bolts as it is to not tighten them sufficiently.

Important: The torque settings should be re-checked regularly.

If other wheel bolts are used please ensure the torque settings are as follows:

- M10 - 49 Nm (36 ft. lb)
- M14 - 135 Nm (99.5 ft. lb)
- M16 - 210 Nm (155 ft. lb)

Special Note -Aluminium Wheels

For aluminium wheels use M12 x 1.5 pitch 26mm thread length 10.9 Grade 60° conical fixing.

The standard M12 x 1.5 60° Conical Wheel bolts are NOT SUITABLE for aluminium wheel rims. Special wheel bolts should be used.

Jacks

The Corner Steadies Should never be used to jack up the caravan. When jacking becomes necessary use the AL-KO Side Lift Jack or 2-Tonne Jack system.

NOTE: It is essential that the car and caravan are hitched together before commencing jacking. All AL-KO chassis from 1992 onwards have 2 holes punched in the chassis members, each side (rear of the axle); to accept the brackets for the Jack(s). (

Corner Steadies may be used for stability ONLY, when the caravan is in the jacked position.

The caravan should never be lifted by jacking up under the chassis member.

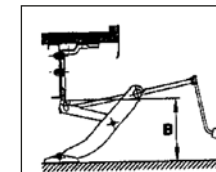

Side Lift Jack

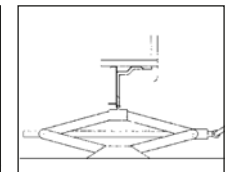

2 Tonne Jack

If working under the caravan in an elevated position, axle stands must be used for safety. Wheel chocks for the opposite wheel(s) are also advisable.

CHASSIS MAINTENANCE

Jockey Wheel

Lubricate screw thread and wheel spindle periodically.

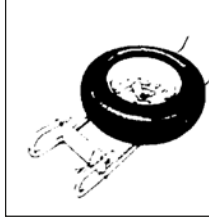
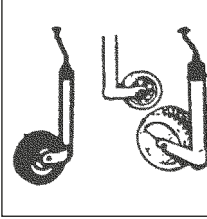
**Spare Wheel Carriers**

The telescopic frame tubes should be lubricated periodically.

Owners Club	192
Spares and after sales Supercare	192
Repair facilities	192
Caravan Clubs	193
Motoring Associations	193
Trade Association	193
Change of ownership	195
Index	198

USEFUL INFORMATION

OWNERS CLUB

The Owners Club is a completely independent organisation run for the benefit of the caravan owners. They have numerous rallies during the year in various parts of the country. Apart from the friendliness and companionship the Club generates it is also actively engaged in charity work for those less fortunate than ourselves. The address of the Secretary of the Owners Club can be obtained from the Swift Group website.

SPARES AND AFTER SALES CUSTOMER CARE

A catalogue of spare parts are available through our Swift Group Dealer Network, from door catches through to spare wheels. Please note, all parts enquiries must be directed through your dealer, as the Swift Group does not operate a direct retail service.

We endeavour to supply parts for vehicles up to 8 years old. If the original part is no longer available your dealer should be able to source a suitable alternative.

Note: Please remember to quote chassis number when ordering any items from your dealer.

REPAIR FACILITIES

Should you be unfortunate to encounter damage to your vehicle, we have a number of approved workshops and dealerships with workshop facilities to undertake such repairs. Details of which can be found via our website: www.swiftgroup.co.uk/find-a-dealer

CLUBS AND TRADE BODIES

The enjoyment of caravanning can be greatly enhanced by membership of one or more of the various caravanning, motoring and holiday clubs. Here are some useful addresses:

CARAVAN CLUBS**The Caravan Club,**

East Grinstead House,
East Grinstead
West Sussex, RH19 IUA

Tel: 01342 326944
www.caravanclub.co.uk

The Camping and Caravanning Club,

Greenfields House,
Westwood Way,
Coventry,
West Midlands.

Tel: 024 7647 5448
www.campingandcaravanningclub.co.uk

MOTORING ASSOCIATIONS**Automobile Association (AA)**

Fanum House,
Basingstoke,
Hants. RG1 2EA

Tel: 08705 448866
www.theaa.co.uk
e-mail: customer.services@theaa.com

RAC Motoring Services

8 Surrey St.
Norwich
Norfolk
NR1 3NG
Tel: 01922 437 000
www.rac.co.uk

Green Flag National Breakdown

Tel: 0113 390 4000
www.greenflag.com

RBS Insurance

Churchill Cover
West Moreland Road
Bromley, Kent
BR1 1DP

TRADE ASSOCIATION**NCC**

Catherine House,
Victoria Road,
Aldershot,
Hampshire, GU11 1SS

Tel: 01252 318251
www.thencc.org.uk
e-mail: info@thencc.org.uk

CRIS

HPI Equifax
Dolphin House,
New Street,
Salisbury,
Wiltshire SP1 2TB

Tel: 01722 411430/422422

CHANGE OF OWNERSHIP

NOTIFICATION OF CHANGE OF OWNERSHIP

If you sell your caravan, please notify the change of ownership by completing this page, detaching it and sending it to:

Swift Group Limited, Dunswell Road,
Cottingham, East Yorkshire HU16 4JX.

Please note that the benefit of any unexpired warranty cannot be transferred to the new owner until the change of ownership details above have been received.

DETAILS OF CARAVAN:	Model:	_____
	Chassis No:	_____
CURRENT OWNER:	Name:	_____
	Address:	_____

NEW OWNER:	Name:	_____
	Address:	_____

Symbols

- 13 pin socket 26
230v mains electrical equipment 63

A

- Acrylic windows 160
Alarm siren 90
Alarm system 88
Alarm tilt sensor 89
Alde heating 100
AL-KO ATC Trailer control system 168
AL-KO Secure immobiliser 40
AL-KO side lift jack 41
ALKO Spare wheel and carrier tips 29
Appliance consumption figures 64
Arrival on site 31
Assistance 8
Awning light operation 89
Awnings 156

B

- Battery box 82
Battery installation 83
BBQ point (external) 148
Bedding 151
Blinds 153
Blown air heating 100
Breakaway cables 27

C

- Caravan clubs 193
Caravan exterior 160
Caravan handling 29
Caravan interior maintenance 162
Caravan motor movers 157
Caravan movers 160
Caravan terms 14
Caravan towing code 14
Care of laminate tops, tables,
furniture and doors 155
Cassette toilet faults 147
Cassette toilet Thetford C-200CW,
C-200CWE and C-402C 143
Change of ownership 195
Changing a wheel 30
Chassis 168
Chassis accessories 189
Chassis maintenance 190
Chassis trouble shooting 186
Children 36
Cleaning 160
CO alarm 37
Condensation 161
Cooker 3 burner and hotplate operation 129
CRIS 193
Cycle racks 157
- D**
- Doors 155
Doorscreen 153

E

- Electrical overseas connection 61
Electrical system 61
Escape paths 36
Exterior 230v socket 85
Exterior door 32

F

- Fire alarm test 35
Fire and fire alarm 34
Fire extinguisher 36
Fresh level sensor and cleaning 50
Front locker and sunroof 157

G

- Gas 56
Gas bottles 56
Gas cylinder compartment 57
Gas faults 60
Gas hoses 57
Gas regulator 56
Gas safety advice 58
Gas schematic 55
Generator usage 84

H

- Habitation relay 85
Heki-2 roof light (Seitz) 154
Heki rooflight (mini) 154
Hitch operating instructions AKS 3004 178

I

- Internal water tank (UK Caravans) 46

J

- Jacking points 30

M

- Measurement of nose weight 16
Microwave oven 137
Mirrors 28
Modifications 160
Motoring associations 193
Motorway driving 29
Moving off 28

O

- Owners club 192

P

- Passengers 27
PIR internal movement sensor 89
Plumbing troubleshooting 49
Power control system 66
Power control system faults 77
Preparing for the road 20
Pressure switch adjustment 50
Pressure switches 48
Pre-tow check list 24

R

- Reading lamps 156
Repair facilities 192
Reversing 28
Roof lights 153

INDEX

S	
Security	39
Selecting a pitch	31
Service inspection	10
Shower heads	156
Snaking	22
Solar panel and connection point.	84
Spares and after sales customer care	192
Speed limits	29
Stabiliser friction pads	22
Stability	21
Status 530 directional TV and FM radio antenna	150
Step on hitch cover	157
Stopping on a hill.	31
Suitable towing vehicles.	22
Supplier contacts	9
Swift Talk.	2
T	
Tables	155
Table storage	155
Teb fan	98
Thetford C250 CWE cassette toilet.	139
Thetford refrigerators.	118
Thetford refrigerators trouble shooting	127
The tyre law.	24
Towball	22
Towing vehicle's rear suspension	21
Towing vehicle terms	15
Trade association	193
Truma S 3002 and auto space heater	96
Truma Ultraheat additional electric heating	98
Truma ultrastore.	92
Truma Ultrastore trouble shooting	95
TV inlet in battery box	149
TV storage	156
Types of gas.	57
Types of tyres fitted	22
Typical gas schematic drawing	55
Tyre maintenance.	22
U	
Ultraflow water	51
Unhitching.	32
Useful items.	18
V	
Ventilation	39
W	
Warranty	6
Water faults.	53
Water system.	44
Water tanks.	45
Wheel bolt tightening	30
Windows.	154
Winterisation	164
Wiring of connecting cable and caravan mains inlet	62

All Swift Group models have been certified by the National Caravan Council for compliance with stringent European Standards, British Legislation and industry set Codes of Practice specifically relating to health and safety issues.

The approval process covers the testing and inspection of critical areas of the product from fire safety, weights and dimensions, to gas, electrics and ventilation. Every caravan carries the "NCC Approved Caravan" badge.

The NCC also conduct unannounced inspections at the Swift factory to ensure continued compliance. NCC Approval gives you peace of mind that your caravan is legal and safe.

All Swift Group touring caravans are European Whole Vehicle Type Approved.

This is your assurance that these caravans meet all European regulations, and have been constructed and conform to approved standards of safety and manufacturing.

IMPORTANT CUSTOMER NOTICE

TOURING CARAVAN MODEL YEAR

The model year runs from 1st September to 31st August.

For example, the earliest a 2012 model would be registered under the Caravan Registration Identification Scheme (CRiS) is 1st September 2011.

