



Swift Group, Dunswell Road, Cottingham,  
East Yorkshire HU16 4JX.  
Tel: 01482 875740 Fax: 01482 840082  
email: [enquiry@swiftgroup.co.uk](mailto:enquiry@swiftgroup.co.uk)  
[www.swiftgroup.co.uk](http://www.swiftgroup.co.uk)

Part No.1095313  
Issued July 2011

## **Motorhome Owner's Service & Warranty Handbook**

**Dear owner**

Thank you for deciding to buy one of our new motorhomes.

We are sure you will enjoy many happy hours in it and we hope the information and hints in this handbook will heighten your enjoyment.

The handbook has been designed to give you a general guide to the care, use and maintenance of your motorhome. Whether you are a new or an experienced motorhomer the hints will help to protect your investment.

The information contained will answer most of your queries, but if there are any aspects which are not covered please consult your appointed dealer. We would suggest you make a note of your dealers name and contact information below.

**Dealer Name:**

.....

**Telephone Number:**

.....

**E-mail:**

.....

**Swift Talk**

Swift Talk is the new central forum for the Swift community online. A place for all those united in their love of caravanning, motorhomes, holiday homes and touring in general, to share their experiences, meet new friends and find out a world of information on how to enjoy their touring lifestyle.

The site is packed full of features that actively encourage members, not only to liaise with the Swift Group via the forums, but also interact with each other through publishing their own content, uploading and sharing photos and video, and even posting their own blogs for the community to follow.

Swift Talk is the first place to learn about new product launches, events and Swift Group news, it's also the first place customers can go to as a quick reference to frequently asked questions or to actively take part in the forums; providing valuable feedback on Swift Group products and customer service.

The new online community can even be used to create your own groups, perfect for Owners' Clubs, dealers and exhibitors to attract new members, publicise and build awareness for upcoming events, rallies and shows.

Anyone who owns, uses, or is thinking of buying a Swift Group caravan, motorhome or holiday home, or would just like to be part of the growing Swift community is actively encouraged to sign up, create their own content, and start talking!

**Just visit [www.swift-talk.co.uk](http://www.swift-talk.co.uk) and become part of a unique online experience.**



Warranty .....	5
Motorhome code .....	15
Preparing for the road .....	19
En-route .....	27
Safety & security .....	31
Arrival at site .....	39
Services .....	41
Electrics .....	63
Fitted equipment .....	89
Maintenance .....	163
Useful information .....	173



## WARRANTY INFORMATION

Warranty and guarantee cover .....	6
6 year body shell integrity guarantee ('Guarantee') .....	6
3 year SuperSure manufacturer's warranty ('Warranty') .....	6
General terms and conditions .....	6
What to do if you require assistance .....	8
Supplier contacts .....	9
Motorhome - annual service/inspection record .....	10
Annual service / inspection record stamps .....	11

## MOTORHOME WARRANTY

All the illustrations and descriptive matter in this handbook are intended to give a general idea of the motorhome. Changing market and supply situations and our policy of continuous product development may prevent us from maintaining the exact specifications detailed in this handbook. We therefore reserve the right to alter specifications as materials and conditions demand.

Dealers are not agents of Swift Group Limited ("Swift") and have absolutely no authority to bind the manufacturer by any express or implied undertaking or representation.

### Your motorhome has three warranties:

#### • Base Vehicle Warranty – provided by either Fiat or Peugeot.

Your vehicle is either a coach-built motorhome or a panel van conversion motorhome which utilises either a Fiat or Peugeot base vehicle. For a coach-built motorhome, Swift takes a flat bed chassis supplied by either Fiat or Peugeot and adds the coach-built habitation part of the motorhome. For a van conversion motorhome, Swift takes a panel van as supplied by either Fiat or Peugeot and fits out the interior of the van for habitation. Either Fiat or Peugeot provide a manufacturer's warranty for the base vehicle as supplied to Swift by them. For any issues with the base vehicle warranty please contact your local Fiat/Peugeot dealer. Your base vehicle warranty is subject to the terms and conditions contained in the Fiat or Peugeot handbook supplied with the base vehicle and the vehicle must be serviced in accordance with Fiat or Peugeot requirements.

#### • Body Shell Warranty – provided by Swift

For the habitation body shell, Swift will repair (or at its option, replace) any defects with the body shell for 3 years from the date of purchase (or hire purchase), subject to the conditions, terms and exclusions below.

#### • SuperSure Warranty – provided by Swift

For all parts or fittings of your caravan other than the habitation body shell and the Fiat/Peugeot base vehicle, Swift will repair (or at its

option, replace) any defective parts or fittings for 3 years from the date of purchase (or hire purchase) subject to conditions, terms and exclusions below.

The Body Shell and SuperSure Warranties provided by Swift do not cover any parts of the motorhome that are covered by the Fiat or Peugeot warranty.

### Conditions for the Body Shell and SuperSure Warranties

1. You must ensure that the habitation part of your motorhome has an Annual Service (see clause 2 below) within 90 days before or 60 days after each anniversary of the original date of purchase. The third Annual Service must, however, be carried out before the expiry of the 36 month period from the original date of purchase. If you have not performed an Annual Service then Swift will not be obliged to perform any work under this Warranty. Original VAT invoices must be retained as proof that Annual Service have been carried out.
2. The Annual Service on the body shell and habitation area must be carried out in accordance with the requirements in this handbook. You will be responsible for any charges made for an Annual Service. If the Annual Service is performed by an authorised Swift Group Service Centre then Swift warrants that the Annual Service has been performed correctly. If the Annual Service is performed by an unauthorised repairer or service centre then if the Annual Service has not been performed in accordance with the requirements in this handbook and/or work has been performed on your motorhome that is defective or faulty, then Swift will not be obliged to perform any work under this Warranty (insofar as it relates to defective or faulty work or defective Annual Service).
3. All new motorhomes must be registered with Swift within 6 weeks of purchase as new.
4. The benefit of the Body Shell and SuperSure Warranties may be transferred to a new owner if the motorhome is re-sold, provided that the motorhome has been serviced in

accordance with the requirements of this handbook, and details of the change of ownership have been supplied to Swift using the change of ownership form set out in this handbook as soon as reasonably practicable after the change.

5. If any repairs are identified as being necessary to the body shell or habitation areas during an Annual Service or otherwise, Swift will only pay for Warranty work performed by an authorised Swift Group Service Centre. The motorhome must be made available to an authorised Swift Group Service Centre within 6 weeks of the date the repair need was identified for the work to be carried out. The cost of transporting, towing or moving the motorhome by any means to or from the place of repair is the responsibility of the owner.
6. **The Body Shell and SuperSure Warranties only apply to motorhomes purchased and used primarily within the UK, which means that the motorhome is not used for continuous journeys outside of the UK of longer than 90 days per journey. Please refer to the Fiat or Peugeot handbook for use of the base vehicle outside the UK.**

### Terms

7. The Body Shell Warranty covers any defect with the panels and seams of the coach built habitation part of the motorhome. This includes body leaks, delamination of panels or floor, water ingress through any permanently sealed seam joints.
8. In the first 12 months the SuperSure Warranty will cover any defect other than those specified in the Exclusions below.
9. In the years 2 and 3 the SuperSure Warranty will only cover any defect with the following components:
  - Water system; heater, fresh water tank, water pump, water gauges, taps and shower heads;
  - Heating system and components;
  - Main proprietary items ( for example fridge, toilet, cooker);

- Auxiliary electrics; and/or
- Windows (excluding window furniture and blinds).

In years 2 and 3, any defect specified in the Exclusions will not be covered.

### Exclusions

10. Swift shall not be liable under the Body Shell and SuperSure Warranties for any defect related to or arising from the following:
  - The failure of a component for reasons of fair wear and tear;
  - Damage resulting from freezing, fire, over heating or accidents (whether caused by the user or a third party);
  - Misuse of any component;
  - Normal deterioration, corrosion, intrusion of foreign or harmful bodies, lack of servicing or negligence of any person other than Swift which causes stoppage of or impairment to the function of any component of the motorhome;
  - Replacement of parts which have reached the end of their effective working life because of age and/or usage;
  - Cleaning or adjustment of any assemblies;
  - Cosmetic finishes to kitchen sinks, cooker tops, vanity units, shower trays; and/or
  - Routine maintenance items which are part of the annual service including lubricants, rubber gas hose, the cleaning of the heater and fridge flues, the replacement of gas jets, the resealing and/or replacement of shower room sealant, and the adjustment and lubrication of locks.

## ASSISTANCE

11. In addition to the exclusions above, in years 2 and 3 of the SuperSure Warranty Period, Swift Group Limited shall not be liable under this Warranty for any defects related to:

- Any audio equipment;
- Any microwave; and/or
- Any TV.

12. Swift shall not be liable under the Body Shell and SuperSure Warranties if the motorhome has been neglected, misused, modified or used for hire or reward or if the identification marks (chassis/VIN numbers) have been removed or defaced. The motorhome will be deemed to have been neglected if it has not been serviced and maintained as stated in this handbook or any repairs being identified as necessary at an Annual Service or by a Swift Group Service Centre have not been carried out in a reasonable time.

**You have legal rights under UK law governing the sale of consumer goods. This Warranty does not affect your legal rights.**

The name and address of the Warranty provider is:

Swift Group Limited, Dunswell Road, Cottingham, East Yorkshire, HU16 4JX

To make a claim under this Warranty, contact the Swift Group Service Centre which supplied your motorhome. Alternatively, details of your nearest authorised Swift Group Service Centre can be obtained by contacting the Swift Group Customer Care Department on: 01482 875740 or enquiring on the website: [www.swiftgroup.co.uk](http://www.swiftgroup.co.uk)

### WHAT TO DO IF YOU REQUIRE ASSISTANCE

Congratulations on purchasing your new motorhome. We are confident that you will enjoy many happy holidays. However, should you have an enquiry or require assistance with a problem, we hope that this guide will be of assistance to you.

**If you have a problem, or enquiry with regards to your new motorhome, please follow these steps:**

1. Check the Owners Handbook, paying particular attention to the fault finding advice at the back of the book.
2. Contact your supplying dealer for assistance.

**If you need to contact the Swift Group, please be aware of the following:**

1. When contacting Swift Customer Care, please quote your name, postcode and VIN (Vehicle Identification Number). This can be found at the bottom of the front windscreen, on the plate on the front cross member within the engine compartment and on the Swift manufacturers plate situated on the bulkhead directly behind the front driver/ passenger seat.
2. In most instances, the Customer Care Team will involve your dealer in resolving the issue you are experiencing.
3. If you are contacting the company by email, letter or fax, the Customer Care Team will respond to you within five working days from the date of receiving the correspondence.
4. If you are calling the Customer Care Team, please avoid where possible, Mondays and lunch times.
5. Please be aware that the Swift Group cannot send parts direct from the factory. In all cases, without exception, your dealer must place the order for you.-

## SUPPLIER CONTACTS

### SUPPLIER CONTACTS

A number of Swift Group suppliers manage their own Technical and Warranty related queries. Where a customer has a question relating to a product manufactured by a company listed below, we would advise that the first contact should be directly with them.



#### Sargent Electrical Services

Unit 39, Tokenspire Business Park, Beverley, East Yorkshire, HU17 0TB

Phone: 01482 678981

Fax: 01482 678987

E-mail: [support@sargentltd.co.uk](mailto:support@sargentltd.co.uk)



#### AL-KO Kober Limited

South Warwickshire Business Park  
Kineton Road, Southam,  
Warwickshire, CV47 0AL

Fax: 01926 818562

Email: [mail@al-ko.co.uk](mailto:mail@al-ko.co.uk)



#### Truma UK Ltd.

Park lane, Dove Valley Park,  
South Derbyshire, DE65 5BG

Phone: 01283 586020

Fax: 01283 586029



#### Thetford Ltd.

Unit 19, Oakham Drive,  
Parkwood Industrial Estate,  
Rutland Road, Sheffield, S3 9QX

Phone: 0114 273 8157

Fax: 0114 275 3094

Email: [info@thetford.eu](mailto:info@thetford.eu)



#### Alde International (UK) Ltd

Regent Park, Park Farm South,  
Wellingborough, Northants, NN8 6GR

Phone: 01933 677765

Fax: 01933 674975

Email: [info@alde.co.uk](mailto:info@alde.co.uk)

## SERVICE INSPECTION

**MOTORHOMES - ANNUAL SERVICE/INSPECTION RECORD**

In order to comply with the warranty, you must have your motorhome inspected and serviced by an authorised Swift Group Service Centre at least once per year.

It is important that the Owner's Handbook is stamped on the appropriate page by the authorised Swift Group Service Centre. Failure to do this will invalidate the warranty and the transfer of the warranty on the change of ownership.

The inspection should take approximately two to four hours and will cover the areas dealt with in the annual service check list. Any areas requiring service and/or maintenance will be highlighted by your dealer and we recommend that you authorise any necessary work to be carried out.

NB. It is essential, to validate the warranty, that an annual inspection be carried out by an authorised Swift Group Service Centre covering the items listed.

1. Damp and lamination test.
2. Chassis and chassis to body security.
3. Corner steadies.
4. Motorhome step.
5. Road lights, wiring and reflectors.
6. Internal lights and 12V DC system.
7. Water heater - gas and 230V AC (if fitted).
8. Hob, grill and oven (if fitted).
9. Refrigerator 230V AC, 12V DC and gas.
10. Gas system.
11. Water pump, taps and water system.
12. Mains 230V AC system.
13. Windows and fittings.
14. Smoke alarm and battery.

15. Roof lights.
16. Furniture hinges/stays etc.
17. Exterior locks and hinges.
18. Grab handle security.
19. All internal vents.
20. Oil seals.
21. Blinds and fly screens (if fitted).
22. Blown air heating and gas fire systems

Annual service / inspection record stamps  Motorhome model: .....  Year: .....  Chassis VIN: .....	<b>1st SERVICE</b> DATE: DEALER'S STAMP   We certify that an annual service has been carried out in accordance with the handbook.
<b>2nd SERVICE</b> DATE: DEALER'S STAMP   We certify that an annual service has been carried out in accordance with the handbook.	<b>3rd SERVICE</b> DATE: DEALER'S STAMP   We certify that an annual service has been carried out in accordance with the handbook.
<b>4th SERVICE</b> DATE: DEALER'S STAMP   We certify that an annual service has been carried out in accordance with the handbook.	<b>5th SERVICE</b> DATE: DEALER'S STAMP   We certify that an annual service has been carried out in accordance with the handbook.
<b>6th SERVICE</b> DATE: DEALER'S STAMP   We certify that an annual service has been carried out in accordance with the handbook.	<b>7th SERVICE</b> DATE: DEALER'S STAMP   We certify that an annual service has been carried out in accordance with the handbook.



SERVICE INSPECTION

<p><b>8th SERVICE</b>                  DATE:                  DEALER'S STAMP</p> <p>We certify that an annual service has been carried out in accordance with the handbook.</p>	<p><b>9th SERVICE</b>                  DATE:                  DEALER'S STAMP</p> <p>We certify that an annual service has been carried out in accordance with the handbook.</p>
<p><b>10th SERVICE</b>                  DATE:                  DEALER'S STAMP</p> <p>We certify that an annual service has been carried out in accordance with the handbook.</p>	<p><b>11th SERVICE</b>                  DATE:                  DEALER'S STAMP</p> <p>We certify that an annual service has been carried out in accordance with the handbook.</p>

WARRANTY

Code of conduct ..... 16  
The Country code..... 18  
The Coastal code ..... 18

**Code of conduct****CAMP SITES****Arrivals**

Report to reception immediately on arrival.

**Vehicle Movement**

Keep to roadways unless otherwise directed.

Adhere to speed limits. Note that these are generally 10 mph. (Remember that the stopping distance on grass is considerably greater than on tarmac.)

Only a person in possession of a current driving licence may drive on the site.

Park correctly as advised on your pitch. Where possible leave 20 feet of free space around your vehicle.

**Use of Site Appliances**

Use the electrical mains hook-up in the correct manner and with caution.

Ensure that all fresh water taps/connections are turned off after use.

Have care and consideration when using all facilities (toilets and showers etc) and leave clean and tidy. Young children should be supervised.

**Waste Disposal**

If the vehicle is not fitted with a waste water tank, a suitable receptacle should be placed below all waste water outlet pipes. Do not let these containers overflow. Dispose of all waste water where instructed. Empty effluent from chemical toilets where instructed.

To avoid possible damage to sewage purification works, only approved chemical fluids must be used. Under no circumstances should coal tar, phenol or caustic-based fluids be used.

Disposable napkins and similar bulky items must not be put into chemical closet emptying points but should be wrapped in a polythene bag and placed in the container provided. Place all litter in containers marked for the purpose.

**Noise**

Do not make excessive noise.

Children should be restrained from making excessive noise.

Flying kites and model aircraft and the use of items like catapults or air-guns, as well as ball games, should not be permitted among, or close to other vehicles.

Musical instruments, record players, radios and televisions should not be used to the inconvenience of other people on the site.

Open and close doors quietly.

Power generators must be adequately silenced and used with consideration.

**Dogs and other Pets**

All dogs and other pets should be kept under control.

Unless permission has been granted, no animal should be allowed loose on the site and leads must not exceed 10ft.

No animals should be allowed in the shower/toilet blocks.

Do not let dogs foul the site.

**Fire Precautions**

Adhere to and take note of fire precautions noting the whereabouts of the fire points.

**WARNING:** Provide one dry powder fire extinguisher of an approved type or complying with EN3, of at least 1kg capacity, by the main exterior door and a fire blanket next to the cooker.

Familiarise yourself with the operating instructions on your fire extinguisher and the local fire precaution arrangements.

When using a dry powder extinguisher it is suggested that the motorhome be evacuated until the powder has settled, to avoid inhalation.

Unless permission has been granted, barbecues should not be used. If permission is given, consideration should be given to the annoyance that can be caused to other users of the site.

Open fires are not allowed.

**Awnings and Tents**

Awnings and tents should only be used when permission has been obtained.

When on grass and staying for more than a few days, the ground sheet and/or side flaps of awnings should be periodically raised in order to avoid damage to the ground.

**Departure**

Leave the pitch clean and tidy.

On leaving, check out with reception paying the required fees.

**WILD CAMPING**

Camping away from licensed sites, without the permission from the land owner or his agents, is not allowed in the United Kingdom.

When permission has been granted, all aspects of this Code should be adhered to.

On no account should:

- (a) Litter be disposed of other than in the receptacles provided.
- (b) Water be allowed to escape from the vehicle.
- (c) Chemical toilets be emptied except into the disposal places agreed with the land owner.
- (d) Washing or similar be hung outside the vehicle.

**PARKING**

Motorhomes should only be parked in approved places.

When using the facilities of a motorhome, care and consideration should be given to those around them.

**DRIVING**

Before moving off, elevated rooflights and aerials should be lowered and correctly secured, and top hinged windows closed. Likewise all doors and access lockers for gas containers and chemical toilets must be properly secured.

Exterior steps should be properly retracted and secured.

When the vehicle is in motion it is compulsory for all front seat passengers and rear seat passengers to wear seat belts, where fitted.

When using a motorhome on either the public highway or private roads the Highway Code should be complied with and full consideration given to other road users.

In the event of a motorhome travelling slowly the driver of the motorhome should, where possible, pull over in order to let other traffic pass.

**When refuelling or on a ferry ensure the gas system is fully isolated at source.**

**HANDBOOKS (Chassis & converter)**

Before using a motorhome all aspects of the handbooks, produced by the chassis manufacturer and the converter, must be read and adhered to.

The separate chassis manufacturer handbook refers to your motorhome chassis and base vehicle including care and maintenance.

## COUNTRY/COASTAL CODE

**ENVIRONMENT**

Care and consideration should be taken to protect the environment.

Observe the Country and Coastal Codes.

**The Country code**

Enjoy the countryside but respect its life and work.

More people than ever before are exploring the countryside, interested in farming, plant life, bird watching or just observing the general wildlife. Whatever your interest, there is a lot to learn, but please observe the following code:

1. Guard against all risk of fires. Hay and heathland catch alight easily and once ablaze are very difficult to put out.

**REMEMBER:  
FIRE SPREADS QUICKLY.**

2. Fasten all gates.
3. Keep your dog under proper control.
4. Keep to the paths across farm land.
5. Avoid damaging fences, hedges and walls.
6. Leave no litter.
7. Safeguard water supplies.
8. Protect wildlife, wild plants and trees.
9. Go carefully on country roads.
10. Respect the life of the countryside.

**The Coastal code**

As our coastlines are increasingly used for recreation and education, the following suggestions are made to enable us to enjoy our inheritance and preserve it for posterity.

Disturbance may mean DEATH.

DO NOT trample about, or move rocks unnecessarily.

DO NOT frighten seals or seabirds.

DO NOT spill detergents, solvents or fuel from boats as these can kill marine life.

When sailing, moderate your speed - the wash from a fast boat can destroy banks and nests.

Live molluscs and crustaceans need not be collected as souvenirs - dead shells can usually be found.

Shellfish can take years to grow and fines can be imposed for not observing national regulations.

DO NOT pull up seaweeds unnecessarily.

Make your visit instructive - not destructive.

Look at material - don't remove it. Take notes and photographs, not specimens.

Observe by-laws and be considerate to others.

National Trust property and Country Parks have regulations to protect the wildlife. Follow these and the Country and Coastal Codes.

Before moving off .....	20
Motorhome terms.....	20
Loading of vehicle.....	21
Large storage areas.....	22
Roof loading .....	22
Tyres.....	22
Dedicated travelling passenger seating .....	22
Child seats .....	23
Three point seat belts .....	23
Driving licence .....	24
Vehicle classifications .....	24
Advice on towing.....	24

BEFORE MOVING OFF

**Before moving off**

**Check:**

- all gas operated appliances have been isolated, except the en-route heating system if fitted.
- gas cylinders are correctly positioned, secured and turned off unless using en-route heating.
- loose articles including Luton ladder are stowed securely. Do not stow tins, bottles or heavy items in overhead lockers.
- all lockers and cupboard doors are closed and secured.
- main table is stored or locked in its transit position.
- fridge is on 12V operation and door lock is set.
- 230V mains input socket flap is securely closed.
- all drain taps are closed.
- tyre pressures and wheel nuts.
- rear corner steadies are raised.
- exterior roof rack ladder is raised and secured.
- all windows/doors/rooflights are closed and secured.
- TV aerial is lowered and locked into position (where fitted).
- exterior step (where fitted) is retracted/ folded in.
- Ensure exterior service locker is closed and locked (where fitted).

Special attention must be taken to ensure all top hinged windows as well as the Luton windows and rooflights are closed when in transit. All units should be fully closed and latched to prevent damage. The motorhome exterior door should also be locked.

**CAUTION:** Vehicles over 3m high have a max vehicle height label affixed to the drivers sunblind. When planning your route take your vehicle height into consideration

**CENTRAL LOCKING**

The central locking will not activate unless the cab doors are closed. It will however activate with the habitation door open. The habitation door lock will then engage when the door is closed leading to the possibility of being locked out of the vehicle, if the keys are left inside. It is therefore essential that the habitation door is closed before the central locking is activated. To open the habitation door when locked, pull the internal door handle twice.

**Motorhome terms**

**Mass in Running Order:**

This is the mass of the motorhome as stated by the manufacturer, i.e. ex works weight including the driver with 90% fuel / fresh water / gas capacity and standard fixtures and fittings, in compliance with European Directive 92/21/EEC (Masses and Dimensions).

**Note:** Quoted MRO is subject to tolerance, due to weight variation of materials used in Motorhome construction.

**Maximum User Payload:**

The maximum allowable weight to be put into the motorhome whilst it is being driven. This is made up of 4 sections:

Personal effects, conventional load, optional equipment and essential habitation equipment.

The Maximum User Payload is the difference between the Maximum Technically Permissible Laden Mass and the Mass in Running Order.

**Personal Effects:**

Those items which a user can choose to carry in a motorhome and which are not included as Essential Habitation Equipment or Optional equipment.

**Conventional Load:**

A mass allowance for each designated passenger seat.

LOADING VEHICLE

**Optional Equipment:**

Items made available by the manufacturer over and above the standard specification of the motorhome.

**Essential Habitation:**

A mass allowance for liquids in systems not accounted for within the MRO.

**Maximum Technically Permissible Laden Mass:**

The maximum weight for which the motorhome is designed for normal use when being driven on a road, laden.

This mass takes into account specific operating conditions including factors such as the strength of materials, loading capacity of tyres etc.

**WARNING:** Under no circumstances should the axle loadings or the Maximum Technically Permissible Laden Mass of this motorhome be exceeded.

**Nose weight of Towed Trailers:**

The static mass of the trailer towing device on the rear of the towing vehicle.

Notes:

- (i) When measuring the noseweight it is important that the trailer is loaded.
- (ii) The trailer is intended to be towed slightly nose heavy. The nose weight can be adjusted by distribution of the load. The nose weight should be approximately 7% of the actual laden weight (but not greater than the hitch capacity) and at the same time suit the motorhome requirements.

See 'Advice on Towing' page 24.

**Loading of vehicle**

**Warning:** The driver is responsible for arranging the loads so that they comply with the technical weight limits of the specific motorhome model.

See specification handbook.

Correct weight distribution is an important factor in ensuring your vehicle is well balanced and easy to drive. It is therefore necessary to load your motorhome carefully making sure all heavy articles are evenly distributed and are preferably placed in the lower lockers or bed boxes.

**WARNING:** The two longitudinal bars fitted to the roof are there for styling purposes and should not be used for load carrying unless cross bars are fitted.

**WARNING:** Do not travel with televisions or microwaves in overhead lockers unless the appliance was supplied fitted to your motorhome by the manufacturer.

Although it is essential to ensure that the total weight of your motorhome does not exceed the stipulated Maximum Technically Permissible Laden Mass, (MTPLM), it is important to remember that the front and rear axles also have individual maximum weights which must not be exceeded.

To ensure adequate road holding the load on the front axle, under all conditions, must not be less than 40% or more than 70% of the total weight.

Ensure you distribute the payload equally on each side of the vehicle to avoid an imbalance.

These weights, together with the MTPLM, can be found on the Statutory plate adhered to the bulkhead behind the right hand cab seat.

Please take care to ensure you have allowed for the masses of all the items you intend to carry in your motorhome e.g. passengers, optional equipment, essential habitation equipment and personal effects such as clothing, food, pets, bicycles, sailboards, sports equipment etc.

## STORAGE/LOADING

**LARGE STORAGE AREAS**

The large storage areas provided in some motorhome layouts are designed solely for the purpose of carrying personal possessions, these areas must not be used;

- as a habitation area (eg living, sleeping or cooking).
- to carry passengers, animals or livestock.
- for the installation (or use) of any LPG gas operated appliances, (unless supplied fitted by the manufacturer).
- for carrying LPG gas bottle cylinders.
- to carry any flammable liquids, unless properly stored, sealed and secured.
- for the operation of an electrical generator.
- in such a way that the load exceeds the MTPLM and maximum axle loads.

Care must be taken to ensure that exterior doors are closed, locked and that all possessions are properly stored and secured before setting off on any journey.

**ROOF LOADING**

Some motorhome roofs can be fitted with a roof rack (optional).

A maximum load of 50kgs can be evenly distributed on the roof rack system.

This figure MUST NOT be exceeded.

Note: When loading the roof rack, make sure the load is spread evenly and do not allow sharp objects to come into contact with the roof surface.

Do not apply excessive load to the rear suspension of your motorhome or allow the vehicle to reverse with the roof rack access ladder in the down position, touching the ground. This may cause excessive strain on the ladder fixing points.

The roof areas, up to the over cab section, are capable of withstanding an average person's weight (13 stone or 82.5kg).

**Note:** Do not walk on the over cab section.

**WARNING:** the roof may become slippery in adverse conditions, wipe dry before attempting to walk on roof section. Extreme care should be taken to avoid falling from the vehicle.

**WARNING:** When walking on the roof, deck type shoes should be worn – not leather sole

**TYRES**

If a wheel or tyre fitted to a wheel is changed any replacement must be of the same type of construction and size.

The law requires that the tyres and pressures must be suitable for the use to which they are being put. The minimum tread depth must be 1.6mm throughout a continuous band comprising the centre three-quarters of the breadth of the tread and around the circumference of the tyre.

Please refer to base vehicle manufacturer's handbook for tyre pressure information.

This may also be displayed in the driver's or passenger's door aperture.

**DEDICATED TRAVELLING PASSENGER SEATING**

Seat belts are fitted to all travelling seats. Travelling seats are designated by the manufacturer and vary according to the layout you have purchased. Each seat is homologated i.e. tested to all relevant safety requirements. NEVER travel in or attempt to install a seatbelt to a non-designated seat.

**WARNING:** Side facing seats are designed for habitational use only, not for use when the vehicle is in motion.

**Seat belts and legislation**

Designated driver and passenger seats are fitted with seat belts and MUST be worn.

Children, aged up to 3 years of age, must

wear an appropriate child restraint suitable for their age and weight. Children from 3 years of age and up to 135cm (4'5") in height, or 12 years of age, whichever is reached first must use a restraint suitable for their age.

Children over 135cm (4'5") in height or aged 12 or 13 years must wear a seat belt.

Note: It is the legal responsibility of the driver To ensure children aged up to 14 years old are suitably restrained. For passengers aged 14 and over, it is their responsibility (not the driver) that a seat belt is worn.



Fig 1

Designated passenger seats within the habitational compartment of your motorhome are identified (fig. 1). Seat belts are fitted for your safety and must be worn unless a 'Certificate of Exemption from Compulsory Seat Belt Wearing' is held. This Certificate must be produced if asked for by the Police – seat belt offences can result in a fine.

**CHILD SEATS****Choosing/Buying**

Go to a reputable retailer such as Halford's, Mothercare, Toys R Us, John Lewis etc. Most reputable retailers will have trained child seat advisers on site and will offer a fitting service. Ask the advisor to fit various seats to the vehicle. Once a correctly fitting seat has been installed, satisfy yourself on its suitability for your child and the vehicle before buying as it is important to use a correctly fitting seat in your motorhome.

**CAUTION:** The child seat you use in your car may not be suitable for mounting on a motorhome seat.

Choose the right seat for your child's height and weight.

## SEATBELTS

Ensure it has an official approval mark (usually the United Nations 'E' mark). The current UN standards is Regulation 44.03

Never fit or use a second hand car seat. It could have been damaged and may not meet modern standards. The fitting instructions may also be missing.

**Positioning/ Fitting**

Dependant upon the child seat type, the most suitable position for the child seat to be fitted may be the front passenger seat of the cab (NOTE airbag advice below) or the window seat of the forward facing rear seat, the isle seat in the rear is not a recommended position, advice should always be taken from the retailer on the suitability and security of the seat in the motorhome.

Read and follow the child seat manufacturer's instructions for fitting the seat.

All Swift Motor homes are fitted with inertia reel seat belts, however, the child seat must be tight in the adult seat. Push all your weight into the child seat as you tighten the belt.

Keep a copy of the child seat fitting instruction in the motorhome for easy reference.

Any doubts, ask an advisor to show you how to correctly install the seat.

**Airbag**

Never fit a rear-facing child restraint in a seat with an active airbag in front of it.

Forward-facing child restraints should be positioned as far back from the airbag as possible. Check the base vehicle handbook.

**THREE POINT SEAT BELTS**

This section refers to the seat belts located in the habitation area of your motorhome.

**Fastening the seat belt:**

Insert tongue into buckle; a positive 'click' indicates correct assembly.

**Releasing the seat belt:**

Press the red release button, the tongue will be ejected from the buckle.



## DRIVING LICENCE

- The belt is designed for use by one person and must not be put around a child seated on a person's lap.
- The belt is suitable for restraining most child seats and boosters.
- The belt should at all times be adjusted and used in accordance with the instructions. No excessive slackness should be present.
- Once installed the diagonal should pass across the centre of the shoulder and the buckle should lie just on or below the hip.
- Avoid twisting the webbing during use. Webbing must not be allowed to chafe against sharp edges.
- Do not make alterations or additions to the belt.
- Belts that have been cut, frayed, damaged or stressed through impact should be replaced. After impact the motorhome anchorage points should also be checked.
- To clean use warm soapy water only.
- Periodic inspection of the installation will ensure reliability of the seat belt.

## DRIVING LICENCE

Licences issued to drivers who passed their car driving test before 1st January 1997 include categories B+E and C1+E which gives them entitlement to drive motor vehicles up to 7500kg MTPLM.

Drivers who passed their test on or after this date have category B entitlement only, which restricts the entitlement to motor vehicles with up to 8 passenger seats and an MTPLM of up to 3500kg with trailers up to 750kg MTPLM (4250kg combined) or larger trailers providing the combination of the trailer and towing vehicle does not exceed 3500kg and the MTPLM of the trailer does not exceed the unladen weight of the towing vehicle.

Drivers who passed their test on or after the 1st January 1997 will need to take an additional test(s) to gain the B+E and C1+E entitlement.

A number of Swift Group motorhomes have an MTPLM greater than 3500kg, therefore you must check you have the driving licence entitlement for the vehicle you drive.

## Vehicle classifications

Motorhomes up to 3500kg MTPLM are P/LGV (Private Light Goods Vehicles), motorhomes with an MTPLM over 3500kg and up to 7500kg are P/HGV (Private Heavy Goods Vehicles). These are used in defining MOT classifications and vehicle excise duty (road tax) classifications.

## ADVICE ON TOWING

The towing capability of each motorhome differs depending on the specific chassis and engine types, (see 'Towing Capabilities' in your specification handbook).

This takes account of the maximum front and rear axle loadings as well as the minimum front axle loading in two conditions, MRO and MTPLM condition.

Towing in these, and any other condition requires sensible loading and distribution of payloads to ensure the requirements of the towing capability table are met.

When towing, the demands on both the vehicle and driver increase. A trailer reduces manoeuvrability, the ability to climb hills, acceleration and braking capacity and makes the vehicle handle and corner differently.

It will also increase the fuel consumption of the vehicle.

Always brake in good time. Special care must be taken when descending gradients. Change down before going down a steep hill so the engine can act as a brake. Ensure that the towing vehicle tyre pressures are correct and adjusted for full load conditions and that the trailer tyre pressures are as recommended by the trailer manufacturer. Regularly check the operation of trailer brakes and lights.

For maximum stability, when loading the trailer ensure that the loads are properly secured during transit. Position loads so that most of the weight is placed close to the floor and,

## TOWING ADVICE

where possible, immediately above or close to the axle(s). Where the load can be divided between trailer and tow vehicle, loading more weight into the vehicle will generally improve the stability of the combination. After loading the trailer, check that the nose weight and axle loads are in accordance with the manufacturer's recommendations, also check the rear and front axle loads on the motorhome. When calculating the laden weight of the trailer, remember to include the weight of the trailer PLUS THE LOAD.

**NOTE:** Towing regulations vary from country to country. It is very important to ensure that national regulations governing towing weights and speed limits are observed (refer to the relevant national motoring organisation for information). The stated maximum permissible towing weights refer to the vehicle's design limitations and NOT to any specific territorial restrictions.

## Notes:

- Do not exceed the motorhome gross vehicle train weight.
- Do not exceed the maximum front & rear axle loads on the motorhome.
- Ensure the motorhome front axle load is never less than 40% or more than 70% of the total weight.
- Motorhomes with an MTPLM up to 3500kg which have European Type approval can only be fitted with a type approved towbar complying to 94/20/EC.
- The limit for towing an un-braked trailer is 750kg (based on VIN plate not actual weight), this applies to a towed car.
- A car dolly with a car with a GVW over 750kg in place is considered as two trailers, these are legal for use for recovery but under the Road Traffic Regulations Act 1984 the combination is limited to 40 mph on motorways and dual carriageways and 20 mph elsewhere. A car dolly is not legal for transportation (there is a very specific difference between recovery and transportation. Recovery is defined as the removal of a broken down vehicle to a place of safety).

- The maximum permitted vehicle combination length is 18.75m, however any combination must ensure compliance with the turning circle requirements of Construction and Use regulations 1986 & 97/27/EC.

PREPARING FOR THE ROAD

Cruise Control .....	28
Removal of spare wheel on ALKO conversion .....	28
Removal of FIAT/PEUGEOT spare wheel .....	29

**CRUISE CONTROL**

The driver of the vehicle should always remain seated and in control of the vehicle when cruise control has been engaged. Never leave the driving seat for any reason when the vehicle is underway.

**REMOVAL OF SPARE WHEEL ON ALKO CONVERSION:**

Caution: Exercise care when lowering the wheel and frame due to its weight.

**Removal**

- Spare wheel in the stowed position (Fig. 1).
- Remove the securing pins (a) from the supports (b) at each side of the spare wheel carrier frame (c) (Fig. 2).
- Lift the wheel carrier frame (c) slightly and move the frame supports (b) forward and clear of the carrier frame (Fig. 3).
- Lower the carrier frame and wheel to the ground (Fig. 4).
- Remove the spare wheel.

**Replacement**

Replacement is a reversal of the removal procedure. Ensure the securing pins (a) are correctly located in the frame supports (b).



Fig.1

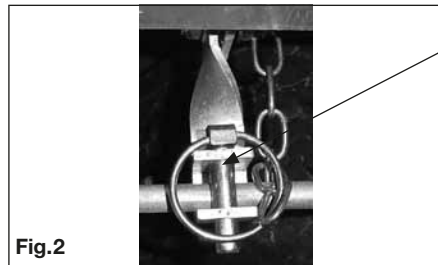

Fig.2

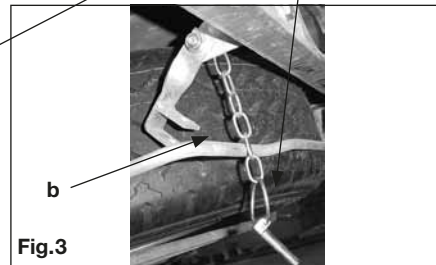

Fig.3



Fig.4

**REMOVAL OF FIAT/PEUGEOT SPARE WHEEL:**

- the ground should be flat and adequately firm.
- turn the engine off and engage the handbrake.
- engage first gear or reverse.

**Removal**

- wheel restraining device screw (fig 1) – rear right side of vehicle
- use the extension and wrench provided to operate the wheel restraining device screw (fig 2).
- when the wheel is fully lowered (fig 3) and the restraining device screw can turn no more, use the wrench to pull the wheel out (fig 4).
- loosen the knob and remove the support to release the wheel (fig 5 & 6).



Fig. 1



Fig. 3



Fig. 5



Fig. 2



Fig. 4



Fig. 6

**Replacement**

Replacement is a reversal of the removal procedure.

**Caution:** Exercise care when handling the wheel due to its weight.

EN ROUTE

Fire ..... 32

Model - SI 601 Smoke Alarm Operation ..... 32

Alarm test ..... 33

Escape paths ..... 34

Children ..... 34

Ventilation ..... 35

CO Alarm ..... 36

Hartal Exterior Doors ..... 38

## FIRE AND FIRE ALARM

**FIRE**

**Important:** Your attention is drawn to the notice affixed inside the wardrobe advising on fire precaution, ventilation and what to do in case of fire.

**IN CASE OF FIRE**

1. Get everyone out of the motorhome as quickly as possible using whichever exit is the quickest, including windows. Do not stop to collect any personal items.
2. Raise the Alarm. Call the Fire Brigade.
3. Turn off the gas supply valve if it is safe to do so.
4. Turn off the electricity supply at supply point.

**MODEL- SI 601 SMOKE ALARM OPERATION****Normal condition**

The red LED on the front should flash once every 40 seconds to show the alarm is active.

**Low Battery Condition**

**IMPORTANT:** Your smoke alarm requires a battery with a sufficient capacity of power to operate correctly. This must also be correctly installed.

Should your smoke alarm enter a low battery condition, the unit will emit an audible 'chirp' once every 40 seconds. When this occurs you must replace the battery immediately. Your smoke alarm will continue to warn of this low battery condition for at least 7 days, however, failure to change the battery after this time would mean your smoke alarm has insufficient power to alert you in a real fire situation.

**BATTERY REPLACEMENT**

**IMPORTANT:** Only the following batteries can be used for replacement. Use of a battery other than those recommended below may have a detrimental effect on the detector's operation. Use of a lithium (long-life) battery could provide power for 10 years under normal operating conditions, meaning there is no need for an annual battery change.

**NOTE:** The alarm cover can't be installed without a battery fitted.

**NOTE:** Upon delivery the battery may be fitted with a protective cover. Please ensure this is removed before use.

**Carbon-Zinc type:**

Eveready Energizer 1222;  
Gold Peak 16045 (UL).

**Alkaline Type:**

Energizer 522; Duracell MN 1604; Duracell 9V Ultra; Energizer 9V Ultra+; Gold Peak 1604A.

**Lithium (long life) type:**

Ultralife U9VL

1. Remove the alarm from its mounting plate by turning anti-clockwise



2. Remove the existing battery and replace with a new battery. From the list on this page, making sure that the positive and negative connections are in the correct position. If unsure see the alarm user manual.



3. Replace the alarm on its mounting plate, lining up the large central vent on the front of the alarm, with the 'X' that is moulded into the plastic on the mounting plate (if unsure see page 13 of the alarm user manual). Ensure the unit is securely fitted.



4. Test your alarm as explained in the next section 'Alarm Test'.

## FIRE ALARM

**ALARM TEST**

1. Press the test button in the centre and release.



2. The unit will emit a loud (85dB at 3 meters) alarm for around 5 seconds and stop automatically.



3. The red LED on your alarm will flash rapidly during the audible signal.



## FIRE ALARM

**NOTE:** The test button accurately tests the alarm's smoke sensing circuit, there is no need to test your alarm with smoke. If your smoke alarm fails to give an audible test signal, please refer immediately to the troubleshooting guide at the end of the user manual.

**WARNING:** Test your smoke alarm at least once per week

Your smoke alarm has been designed to be as maintenance - free as possible and although the unit requires only battery maintenance for its entire life, there are several things you must do to keep it working properly.

**CAUTION:** Your smoke alarm is a sealed electrical device and no attempt should be made to open the case. Attempting to open the case will invalidate your Warranty.

**CLEANING:** As a minimum your smoke alarm should be cleaned once every 3 months using your vacuum cleaner fitted with the soft brush attachment.



**WARNING:** Your smoke alarm may false alarm when it is being cleaned using a vacuum cleaner.

**IMPORTANT:** Do not use solvents or cleaners on your smoke alarm, as they may cause damage to the sensor or circuitry. The unit can be wiped with a slightly damp cloth.

**Warning:** The electronic test button provides a full test of the unit's functionality. DO NOT try to test the alarm with a naked flame, as this may present a potential fire hazard.

**WARNING:** Never use portable cooking or heating equipment other than electric heaters that are not of the direct radiant type, as it is a fire and asphyxiation hazard.

**WARNING:** Appliances such as cookers must not be used for heating.

### Fire Extinguisher

It is recommended that a dry powder fire extinguisher be carried inside your motorhome at all times.

When using a dry powder extinguisher it is suggested that the motorhome be evacuated until the powder has settled, to avoid inhalation.

A fat pan fire should not have a fire extinguisher aimed at it. It should be smothered with a fire blanket.

**WARNING:** Provide one dry powder fire extinguisher of an approved type or complying with ISO 7165, of at least 1kg capacity, by the main exterior door and a fire blanket next to the cooker.

Familiarise yourself with the instructions on your fire extinguisher and the local fire precaution arrangements.

### Escape paths

It is important that you do not block escape paths to emergency exits with obstructions or hazards.

### Children

Do not leave children alone in the motorhome in any event. Keep potentially dangerous items out of reach, as at home e.g. matches, drugs etc.

## VENTILATION AND SECURITY

### Ventilation

All motorhomes comply with BS EN 721. The ventilation points on your motorhome are fixed points of ventilation which are required by the European Standards.

All motorhomes have ventilation at high level and low level which have been calculated to suit the individual needs of your motorhome.

High level ventilation is achieved by means of the roof lights and washroom roof ventilators (where applicable). The low level ventilators are positioned in the entrance door stepwell.

Under no circumstances must these vents be blocked or obstructed.

It is advised that fixed ventilation points are checked and cleaned (if necessary) on a regular basis using a small brush and a domestic vacuum cleaner.

Additional night time ventilation is obtained by releasing the window catches and placing them in the second groove. Note the windows are not sealed from rain in this position.

As the ventilation levels are calculated to suit each models requirements there should be no modifications made which may result in reduced ventilation levels.

**WARNING:** Do not obstruct ventilation.

### SECURITY - Motorhome theft:

The theft of a motorhome can occur in the most unlikely circumstances; from a motorway service area or even an owner's driveway. Secure all windows and doors when your motorhome is unoccupied even if only for a short length of time.

### VIN (Vehicle identification Number)

Record your motorhome VIN which can be found on the lower edge of the base vehicle front windscreen and the plate located on the front cross member under the bonnet.

Make a note of these numbers in the space provided at the front of this handbook and make a separate note of the numbers to keep safe at home.

### Additional security

Consider fitting any device which might deter intrusion by thieves. Customers are advised to identify their motorhome with a method for subsequent identification if other forms of identification have been altered or removed.

Free crime prevention advice about securing your motorhome, protecting your valuables, property marking either at home or whilst on site, can be obtained from the Crime Prevention Officer through your local Police station.



## CO ALARM

## CO ALARM

## Fireangel CO-9X Carbon Monoxide Alarm

**WARNING:** Please read the full user instructions provided.

## CARBON MONOXIDE

Known as the silent killer, Carbon Monoxide is an invisible, odourless and tasteless gas.

## What are the symptoms of carbon monoxide poisoning?

Early symptoms of carbon monoxide (CO) poisoning can mimic many common ailments and may easily be confused with flu or simple tiredness. Symptoms to look out for include:

- tiredness
- drowsiness
- headaches
- giddiness
- nausea
- vomiting
- pains in the chest
- breathlessness
- stomach pains
- erratic behaviour
- visual problems

**Anyone with these symptoms should immediately turn off all appliances and seek medical attention.**

## WHAT TO DO DURING AN ALARM

- Keep calm and open the doors and windows to ventilate the property.
- Stop using all fuel burning appliances and ensure, if possible, that they are turned off.
- Evacuate the property leaving the doors and windows open.
- Ring your gas or other fuel supplier on their emergency number; keep the number in a prominent place.

- Do not re-enter the property until the alarm has stopped. When exposed to fresh air it can take up to 10 minutes for the sensor to clear and the alarm to stop depending on the level of carbon monoxide detected.
- Get medical help immediately for anyone suffering the effects of carbon monoxide poisoning (headache, nausea), and advise that carbon monoxide poisoning is suspected.
- Do not use the appliance again until it has been checked by an expert. In the case of gas appliances the engineer must be Gas Safe registered.

## ACTIVATING THE ALARM

See diagram below

Your detector comes complete with an integrated power pack that will provide power for its entire operational life. To activate the power pack you need to pull the disabling tab (see image). This will in turn pull out the metal disabling clip, which is attached to the end of the tab, from the disabling socket which is situated on the underside of the detector. Retain the disabling tab for future use by taping it to page 20 of the CO-9X user manual.

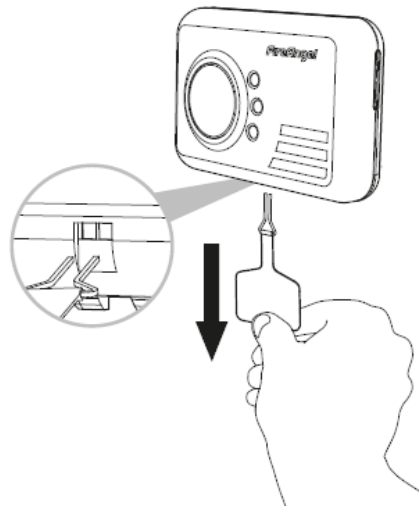

## NORMAL OPERATION OF THE ALARM

When the detector is activated the Power LED will begin to flash green once every minute to indicate that the detector is receiving power from the power pack and is fully operational.

## TESTING THE ALARM

Test the sounder, power pack and circuitry by pressing and holding the centre of the Test/Reset button briefly to confirm that the detector is operating properly. The sounder will sound as soon as the button is pressed, and the Alarm LED will illuminate red indicating that the sounder is working and the power pack is providing power to the unit. This test for the sounder, power pack and circuitry should be performed on a weekly basis. This should be continued for the lifetime of the product.

**WARNING:** Prolonged exposure to the sounder in close proximity to your ears may damage your hearing. Under normal operating conditions, the power pack will last for the lifetime of the product i.e 7 years. The detector will not protect against the risk of carbon monoxide poisoning when the power pack has drained

## SENSOR TESTING.

The alarm manufacturer recommends that this is carried out monthly. See of the CO-9X user manual for more details.

## CO ALARM OPERATION WHEN CO DETECTED

The higher the concentration of carbon monoxide detected by the detector, the quicker it will respond. When sufficient carbon monoxide is detected a loud audible signal (85 dB at 1m (3 feet)) will be emitted and the Alarm LED will flash red once every second.

The Alarm will sound:

- Between 60 and 90 minutes when exposed to a minimum of 50ppm of CO.
- Between 10 and 40 minutes when exposed to a minimum of 100ppm of CO.

- Within 3 minutes when exposed to a minimum of 300ppm of CO.

## FAULT / LOW POWER PACK SIGNAL:

The unit continuously checks the settings of its sensor and circuitry. If any of these settings are found to be incorrect or if the power pack becomes low then the detector will emit a single chirp once per minute and the Fault LED will flash yellow once per minute for up to 30 days.

**IMPORTANT:** This does NOT mean that the detector has detected carbon monoxide.

## MAINTENANCE

Your detector will alert you to potentially hazardous CO concentrations in your home when maintained properly. To maintain your FireAngel detector in proper working order, and to ensure that the sensor will last for the lifetime of the product, it is recommended that you:

- Test the sounder, power pack and circuitry of your detector at least once per week by pressing the Test/Reset button briefly (see above).
- Perform the Sensor Test once every month (See of the CO-9X user manual for more details).
- Keep the detector free of dust by gently vacuuming the case with a soft brush attachment once per month.

To prevent the possibility of contaminating the sensor in your detector and thus affecting its reliability:

- Never use cleaning solutions on your detector. Simply wipe with a slightly damp cloth.
- Do not paint the detector.
- Do not spray aerosols on or near the detector.
- Do not use any solvent based products near the detector.

### **HARTAL EXTERIOR DOORS**

Where the Hartalite door is fitted to the Sundance/E400 models and remote central locking has been activated, pull the door handle twice to open the exterior door.

Positioning the motorhome.....40

## POSITIONING THE MOTORHOME

### POSITIONING THE MOTORHOME

Note: Check and observe site regulations.

Keep to roadways unless otherwise directed. Adhere to speed limits. Note that these are generally 10mph.

(Remember that the stopping distance on grass is considerably greater than on tarmac.)

Only a person in possession of a current driving licence may drive on the site.

### Selecting a pitch

Do not pitch in such a position that your motorhome will obstruct others coming in.

Try to choose an area which is dry, reasonably level and preferably with a hard base.

If you have no alternative but to pitch on a slope try to ensure that you are facing down the slope, for when you leave.

### Levelling the motorhome

Levelling must be carried out in both directions for the refrigerator and other equipment to function correctly. Stepped levelling boards (Fig. A) or proprietary ramps are ideal for this purpose. Levelling pads or boards should be used under the steadies where the ground is soft or uneven.



**Fig. A Stepped levelling board**



**Fig. A Winding the corner steady**

Lower the rear corner steadies (if fitted) until they are in firm contact with the ground (Fig. A). DO NOT use the steadies as a jack, they are only a means of stabilising the rear of the motorhome. Levelling pads or boards should be used under the steadies where the ground is soft or uneven.

### Awnings and Tents

Awnings and tents should only be used when permission has been obtained. When on grass and staying for more than a few days the ground sheet and/or side flaps of awnings should be periodically raised in order to avoid damage to the ground.

Water System .....	42
Pressure switches .....	46
Pressure switch adjustment.....	46
Pressure switch troubleshooting .....	46
Plumbing Fault Finding .....	46
Water level sensor & cleaning .....	47
Typical gas schematic drawing .....	50
Gas .....	52
Types of gas .....	53
Gas safety advice .....	55
Ventilation .....	56
Gas Fault Finding .....	57
Electrical system .....	58
Overseas connection .....	58
Wiring of connecting cable and motorhome mains inlet .....	59
230V mains electrical equipment power consumption .....	60
Typical appliance consumption figures .....	61

## WATER SYSTEM

**WATER SYSTEM-INTRODUCTION**

All Swift Group motorhome water systems have been designed around a pump fitted within the motorhome. This pump draws water from an under floor or internal water tank, to provide water pressure within the water system, whenever it is switched on and water is available.

The schematic below shows the basic configuration of the water system:

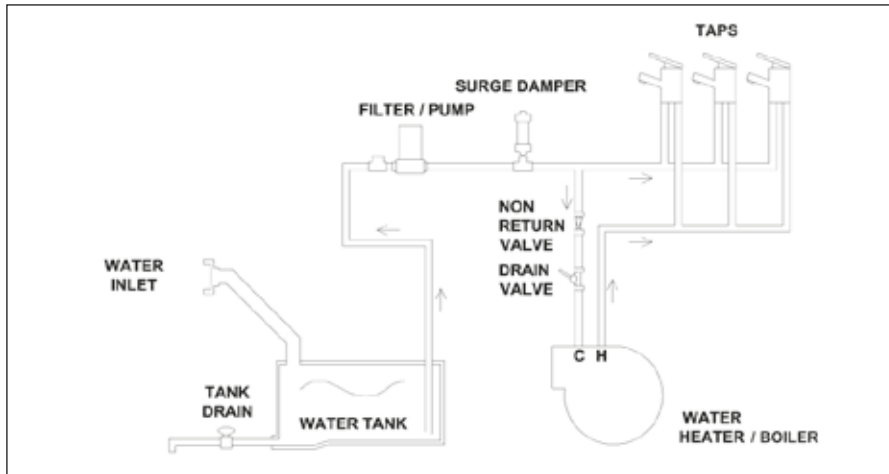

When power is supplied to the pump, it will draw water from the water tank, and pump it to the motorhome taps, shower and water heater.

The pump is fitted with its own pressure switch, and the pump will continue to pump water, until the pressure of water on the output of the pump reaches a pre-set level. For this pressure to be achieved, the taps must be closed.

When the taps are opened, water will leave the tap via the spout, and the pressure in the pipes between the pump and the taps will reduce. Because of this reduction in pressure, the pressure switch on the pump will switch back on and the pump will again run to pump more water.

Close to the pump, the water under pressure is split into two paths:

1. Through blue water pipes routed directly to the cold connection of each tap.
2. To the water heater.

Water from the pump enters the bottom of the water heater. Once the water fills the water heater (typically 10 litres), water then leaves the water heater via a connection at the top of that water heater. This water, which is still under pressure, then routes to the hot connection of each tap via the red pipes.

**To winterise the system please see separate details later in this handbook.**

## WATER TANKS

**FRESH WATER SYSTEM**

- (i) All fittings, including the holding tank, water pipes, taps and connections are of food quality material (to BS6920) and therefore, should not affect the quality of the water used. It is recommended however, that the system is flushed through twice before it is used for the first time, and always cleaned/flushed after it has stood unused for a period of time (eg over the winter period). Care has been taken (using smooth bore pipes etc) to eliminate as many water traps as possible.
- (ii) When filling the fresh water system remember to check that the water source is suitable for use as drinking water and, if you are using a hose pipe or water carrier, that it is also made from nontoxic materials (preferably food quality material).
- (iii) The fresh water tank may be drained either via a plug in the base of the tank accessible via the cleaning hatch or by the drain tap situated externally below the side skirts, or internally inside the furniture (model specific).

**WARNING:** The fresh water system is pressurised by a pump which will continue to operate until it senses a pre-set pressure in the system.

If the fresh water tank is completely empty the pump will be unable to pressurise the system and will operate continuously. In this situation it is essential that, in order to avoid damage to the pump, it is switched off using the pump isolator switch on the distribution panel until such time as the water tank has been filled.



**Lockable water filler inlet**

**Fresh Water Tank**

Your motorhome is fitted with a water tank filled from the outside via a lockable water filler cap. When filling, use a hose manufactured from non toxic material, to prevent tainting of the water. Remember, if the water heater has been drained it will require 10 litre (0.2 gal) of water to fill it.

## PRIMING &amp; CLEANING WATER SYSTEM

**PRIMING THE WATER SYSTEM.**

- (i) Close the water tank drain valve or re-fit the drain bung. (Model specific)
- (ii) Fill the water tank with water.
- (iii) Close the water heater drain valve (see boiler instructions in the fitted equipment section)
- (iv) Open all the taps except the shower tap. Mixer taps should be opened in the central position so that both the hot and cold pipes are purged of air. Ensure the tap spouts are over the sinks.
- (v) Turn on the pump using the button on the control panel (See pump button in paragraph 2.5 of the Electrics section).
- (vi) Turn each tap off in turn as and when the air is expelled and the water runs smoothly from each tap. Move the mixer taps to hot and then cold to check that the air is out of both the hot and cold pipes before turning them off.
- (vii) Whilst holding the shower head down towards the shower drain, open the shower tap and shower head tap until all the air is expelled and the water runs smoothly. Turn the shower taps off.
- (viii) Top up the fresh tank with water.

Please note that priming the system will automatically fill the water heater with water.

Holding the shower head towards the drain, open the shower tap until water flows freely.

Please ensure all taps are fully turned off when not in use (except when winterising).

We recommend the use of Milton 2 sterilising fluid for cleaning and sterilising the water tank and system.

An explanatory leaflet is available from: The Milton Food Hygiene Advisory Service, Whitehall Lane, Egham, Surrey, TW20 9NW

**CLEANING WATER SYSTEM**

Clean the water system at the start and end of the season with sterilising fluid.

**Sterilising**

When cleaning the water system at the start or the end of the season it is advisable to use a sterilising fluid e.g. Milton 2, Chempro SDP or similar.

Flush the system thoroughly to remove the effective fluid traces.

When water is first introduced, or the water supply in the internal tank, runs out, air will be present in the pipework. It is important that every tap is run to remove any air in the system before, for instance, the shower is used. Air left in pipework local to a tap can act as an accumulator and affect the ratio of hot and cold water flowing from other taps or shower mixers in the system.

**System care**

Allowing water to freeze in the system may result in damage to the pump and plumbing system.

Non-Toxic antifreeze for potable water may be used with Truma pumps. Follow manufacturers recommendations.

Do not use automotive antifreeze to winterize potable water systems.

These solutions are highly toxic and may cause serious injury or death if ingested.

**Sanitising**

The water systems, and in particular storage tanks, in motorhomes are susceptible to contamination by bacteria if care is not taken with their use and cleaning. The symptoms caused by bacterial contamination are not purely limited to gastro-intestinal diseases, but may also manifest themselves as ear, nose, throat, eye or skin infections. It is therefore important that you carry out the following procedure prior to using the motorhome each time, even if you boil or filter all water you use for drinking.

## CLEANING WATER SYSTEM

**Separate Water Containers**

1. All water remaining in the container should be disposed of so that the container is empty.
2. The outside of the container should be thoroughly cleansed and washed down to remove any dirt, dust or other contaminant. Water at a suitably hot temperature containing an appropriate detergent is recommended for this purpose.
3. Water should be put in the container, swirled around, then emptied out.
4. The container should then be totally filled with water containing an appropriate sterilant solution and allowed to stand for the recommended contact time (e.g. Milton for 15 minutes).
5. The solution should be emptied from the container.
6. The opening of the container should be cleaned thoroughly with an appropriate prepared wipe impregnated with a sterilant.
7. The container should be inverted whilst stored overnight (if possible).
8. The container must be filled with mains water only and mains water only should be used for the above cleaning procedure.
9. On no account should garden hoses be used to fill water tanks.

**For Systems:**

1. Drain down the system (open all taps to allow air in, enabling the system to drain quickly).
2. Remove any water filters fitted, and replace with a short length of hose or empty filter cartridge (this will ensure the filter is not affected by the disinfectant/sterilant solution).
3. Fill the water system with a disinfectant/sterilant solution (check that the solution at full strength appears at all taps/showers). Allow to stand for the recommended period of time.

4. Drain the system completely.
5. Thoroughly clean the outside of all taps/connectors with a cloth soaked in the disinfectant/sterilant.
6. Flush the system through with clean drinking water until no traces of disinfectant/sterilant can be detected at any tap.

Suitable sterilising chemicals are available from your motorhome dealer, accessory shop, chemist or home-brew shops. It is not, however, recommended to use bleach or sodium metabisulphite.

**Waste water system**

- (i) The waste water holding tank is secured underneath the chassis of your motorhome and is gravity fed.
- (ii) In order to eliminate unpleasant odours as much as possible, only smooth bore pipes are used.

However, should the waste water tank be overfilled, then the waste water will backfill the drain pipes until it eventually appears in the shower base. In order to prevent this, please take note of part (iii).

- (iii) The waste water gauge shows the level of the tank in quarter or half increments, it is therefore, recommended that the waste water tank is checked on a daily basis, emptying when required. This is done by opening the valve located just beneath the side skirt on the exterior of the Motorhome or by turning the handle located inside the vehicle at floor level behind the rear axle, usually found in bed box or wardrobe base (model dependant).

It should be emptied either directly, or via a waste water container (not supplied) into a designated waste water area.

## PRESSURE SWITCH

The purpose of a pressure switch is to monitor the pressure on the outlet side of the pump. When a tap is closed, and the pump continues to run, there is an increase of pressure in the system, and when that pressure reaches a pre-set limit, the pressure switch will turn the pump off.

### PRESSURE SWITCH ADJUSTMENT

Pressure Switch Adjustment, Truma/Flo-Jet pump. (Normally Grey upper section with White lower section/valve housing)

- All of the Truma/Flo-Jet pumps used by Swift are pre-set at 28psi + / -3psi.
- To further adjust the pressure switch setting, a cover cap must be first be removed from the end of the pump to reveal a pressure adjusting screw, as shown in the photos. A maximum of 1/4 turn clockwise or anti-clockwise, from the factory setting, is advised. Turning the screw clockwise 1/4 turn will increase the pressure switch cut-out pressure, turning the screw anti-clockwise will reduce the pressure setting.
- Please note a second screw mounted below the cover cap is set in position with threadlock, this should not be disturbed.



The pump may have to be removed to gain access to the adjusting screw. Drain the water system before removing the pump.

To remove the pump pull the blue taps at right angles to the pipe work and lift the pump out.

## TROUBLESHOOTING

### Pump will not start, when the tap is opened:

- Check fuse(s).
- Check power source(s), and ensure there is sufficient voltage to run the pump.
- Ensure 'pump' LED is illuminated.
- Using a multi-meter, ensure there is power at the pump. If not, refer to your dealer as there maybe damaged cabling or a fault with the fusebox.
- Is the pump hot? If so, allow to cool before retrying.
- Has the vehicle been stored over winter? was it correctly winterised? If no, the pump may have frozen, causing permanent damage.
- The pressure switch may need adjusting. (See pressure switch paragraph in this section for how to do this)

### Pump runs, but will not pressurise system (i.e. no or little water being discharged from taps) - Not Pulsing:

- Ensure that there is water in the fresh water tank.
- Check in-line filter is free from debris and correctly fitted.
- Ensure water system has been primed correctly, (see priming the water system page 44), and there are no air-locks present.
- Ensure there are no restrictions in the plumbing.
- Using a multi-meter, ensure there is power at the pump. If not, refer to your dealer as there maybe damaged cabling or a fault with the fusebox.
- Ensure the inlet side of the pump is

watertight and not allowing air into the system.

- Using a multimeter check that the voltage is between 10 and 14.5 volts. If not, refer to your dealer.

### Pump continues to run (for more than 5 seconds) after taps are closed or pump turns on for no reason:

- Check for leaks on the high pressure side of the pump.
- Ensure water system has been primed correctly, as per the handbook, and there are no air-locks present.
- Ensure the pump is securely mounted.
- Ensure the piping on the high pressure side of the pump is in good condition (not blowing or deforming).
- The pressure switch may need adjusting. (See pressure switch paragraph in this section for how to do this)

### Noisy or rough operation

- Check for leaks on the high pressure and low pressure side of the pump.
- Ensure that all pipes (especially those within 150mm of the pump) are not touching any furniture.
- Ensure the pump is securely mounted

### Pump rapidly cycles (switches on or off) or water pulses from taps, including temperature pulsing:

- Check for leaks on the high pressure and low pressure side of the pump.
- Ensure there are no restrictions in the plumbing
- The pressure switch may need adjusting. (See pressure switch paragraph in this section for how to do this)

## WATER LEVEL SENSOR & CLEANING

### Principle

The sensor, fitted to Swift Group motorhomes are pre-fitted to water tanks, and link to the control unit, via a pre-fitted wiring harness. The sensors, which consist of a number of stainless steel rods or probes, at different lengths, are immersed in the fresh or waste water, and use the conductivity of water, between the probes, to provide a reading to the control unit.

The sensors are 'digital', in that while the conductivity (resistance) value can vary, the fusebox will register any conductivity between the reference probe and the various different length probes, indicating water present.

Normally, even if the rods are dirty, and providing the rods have not bridged by a foreign object, a circuit will still be delivered back to the control unit and a water level displayed.

### Sensor cleaning

The first step, in case of fault diagnosis, is to clean the sensor rods. False water level readings at the control unit can be caused by calcium build-up or foreign objects within the tank bridging the probes. (Especially with waste tanks).

**WARNING:** Only use food safe plastic mesh scourers, which are suitable for domestic use, for cleaning the sensor studs.

1. Remove the sensor from the tank
2. Check the probes for build up of contamination
3. Use clean soapy water
4. Place scourer in water to dampen
5. Apply scourer to the sensor probes with limited pressure
6. Rub sensor probes removing contamination
7. Swill sensor probes with fresh clean water
8. Replace sensor into tank.



## WATER FAULTS

## WATER

Fault	Cause	Remedy
Water not flowing from any tap when operated but pump runs	Freshwater tank empty	Check
	Pump wired in reverse	Check wiring, refer to pump manufacturers instructions
	Pipe inlet or outlet pipe disconnected	Check connections
	Pump pipes restricted by kinking	Check pipes run
	Blockage in pump inlet or outlet pipe	Check, starting inside freshwater tank
	Blocked pump filter Air leak in suction line to pump	Dismantle and clean filter. See pump manufactures instructions.  Check condition of pipe and pipe joints between the water tank and the pump.
Pump does not run	Pump incorrectly wired	Refer to pump manufacturers instructions
	Pump fuse blown	Check wiring connection and then replace with fuse of correct rating
	Battery disconnected	Check connections
	Pump seized or overheated	Refer to pump manufacturers servicing instructions
	Pressure pump sensing switch may have failed	Refer to pump manufacturers servicing instructions
	Contacts may be faulty  Wiring connections may be faulty	Check contacts in plug and socket are clean and making contact  Check wiring connections
Water flows from cold tap but not from hot	Blockage in hot pipeline	Disconnect pipes and inspect
	Heater inlet or outlet pipes kinked preventing flow	Check and re-route if necessary.
	Hot tap failed or blocked	Disconnect and inspect
	Heater non-return valve jammed	Seek service attention

## WATER

Fault	Cause	Remedy
Water flows from hot tap but has reduced flow from cold	Cold water pipe kinked preventing flow	Check and re-route if necessary
	Blockage in cold pipe line	Disconnect pipes after 1st connector and check up to tap
	Cold tap not connected	Refer to installation instructions
	Cold tap failed or blocked	Disconnect and inspect
Reduced flow from both hot and cold taps	Battery condition low causing pump to run slowly	Check battery state of charge, refer to electrical supply note
	If new taps have been fitted they may be restricting flow	Disconnect and check that they have at least 1/4" (6.3mm) bore
	Pump needs servicing	Refer to pump servicing instructions
	Partially blocked pump filter or in-line filter, if fitted	Dismantle and clean if necessary
	Pump outlet pipe kinked restricting flow	Check and re-route if necessary
	Water leak	Check all water connections
Reduced flow from either tap	Pipe kinking restricting flow	Check and re-route if necessary
	Bore size difference in taps	Use taps of equal bore size
If pump motor runs steadily and will not stop	Battery voltage may be too low (below 10.5 volts)	Check that there is water in the container Adjust switch and/or re-charge battery Check all connections in pipework

GAS SCHEMATIC

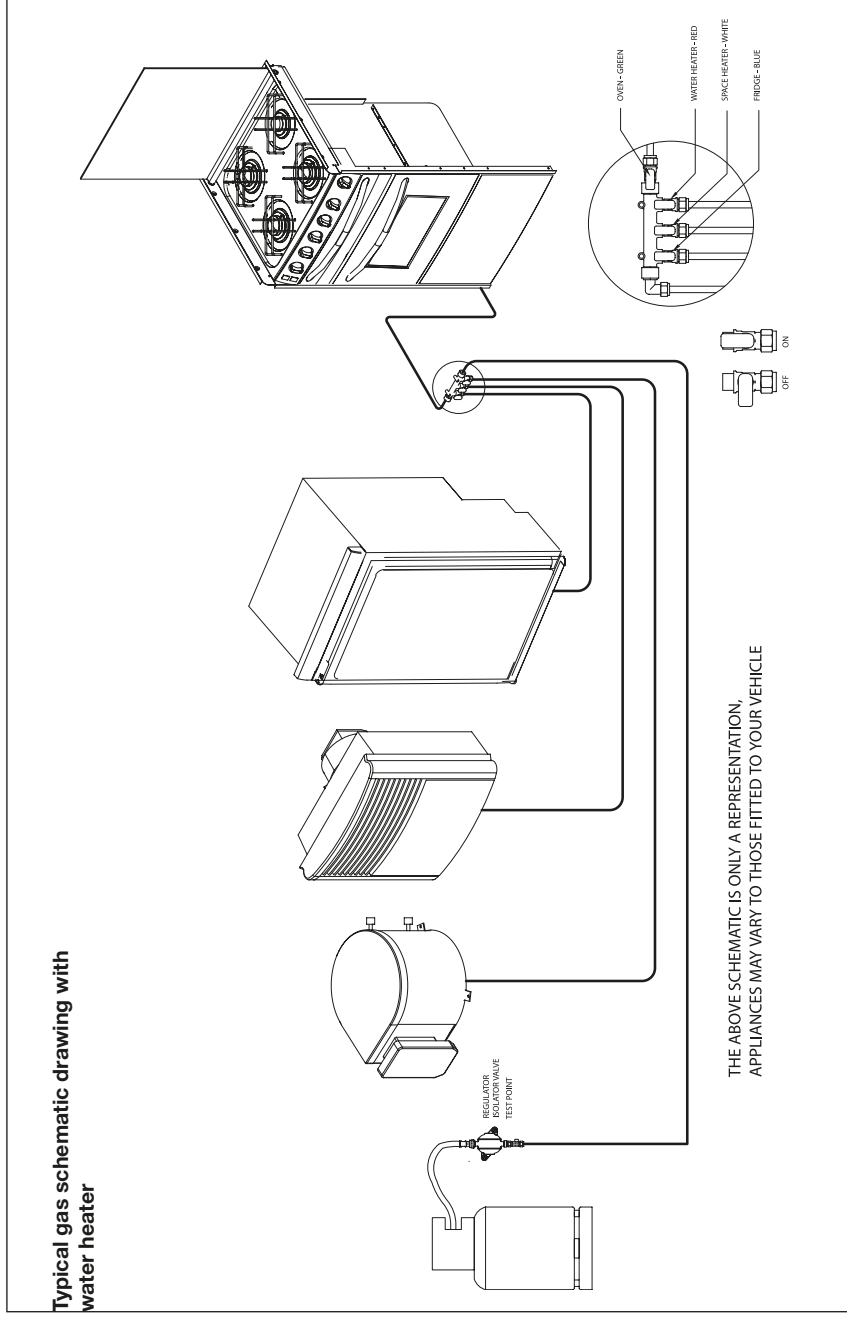

Typical gas schematic drawing with water heater

GAS SCHEMATIC WITH COMBI BOILER

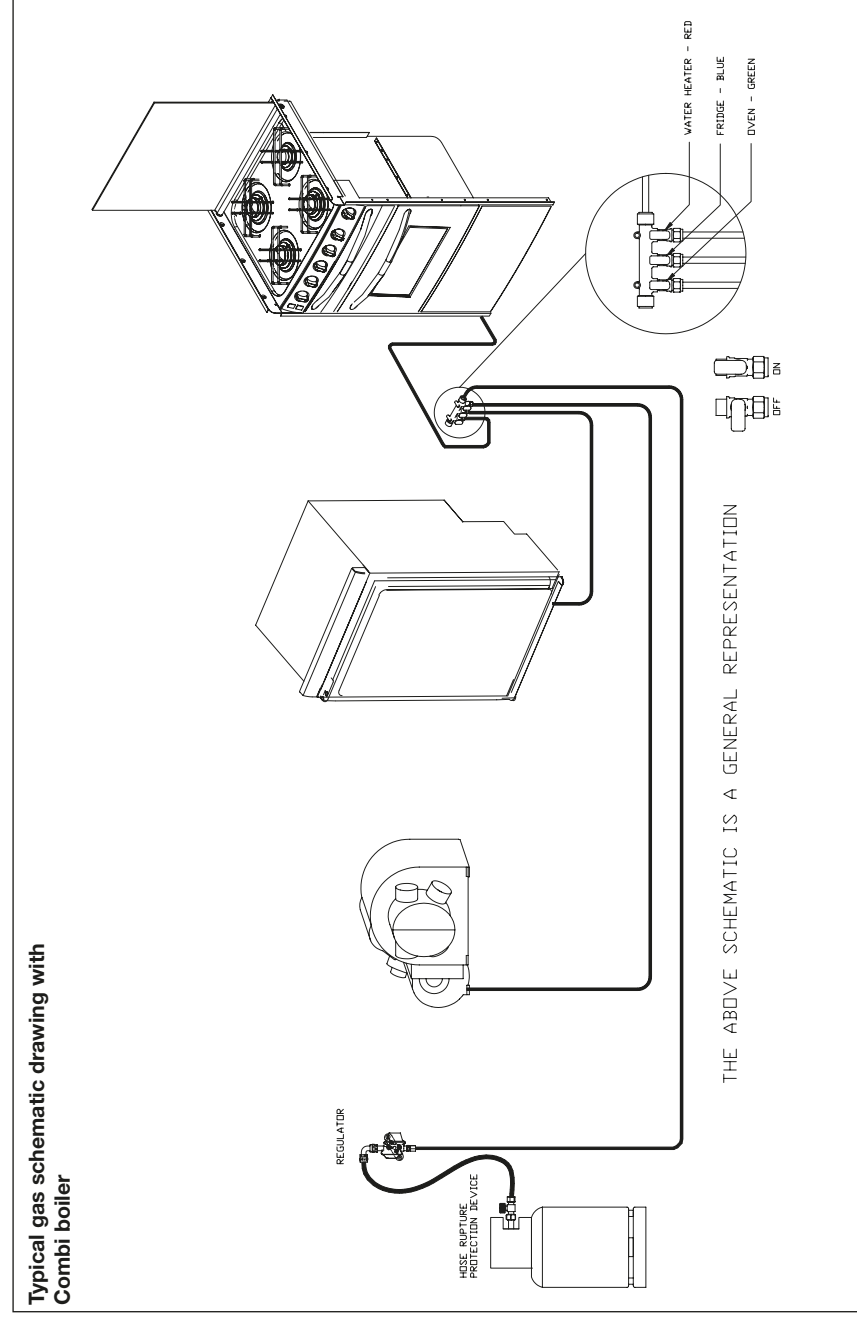

Typical gas schematic drawing with Combi boiler

## GAS

### GENERAL INFORMATION

#### Gas Bottles

Bottled Liquefied Petroleum Gas (LPG) is the most convenient portable source of fuel for your vehicle.

The gas cylinder, cooking and heating appliances should be isolated when travelling unless your motorhome is fitted with en-route heating.

If your Motorhome has a factory fitted habitation en-route LPG heating system that can be used whilst travelling. Fig 1 shows the two safety valves features that are part of the system, these are there for your safety whilst using the system when travelling. When in use ensure all other gas appliances are separately isolated

**Warning:** isolate cylinders when re-fuelling

Regularly check flexible gas hose, joints and connections for tightness. Finally make sure that each gas appliance is working efficiently to the recommendations of the appliance manufacturers.

Only use gas bottle cylinders that are located within their dedicated position within the gas bottle housing, never extend hose - hose lengths must not exceed 400mm.

Regulator for systems approved for en-route heating systems (Fig 1)

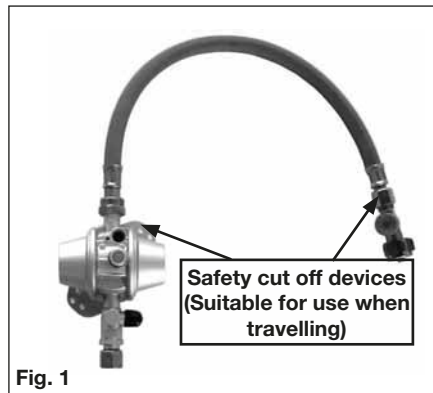

Fig. 1

Your vehicle is supplied with a wall mounted gas regulator plumbed inside the gas bottle compartment. The regulator and all appliances work at a harmonised 30mb pressure, which work with Butane and Propane gas.

Pressure regulation system in this vehicle has a fixed working pressure of 30 mbar with a flow rate of 1.2 kg/H and complies with the requirements of EN 12864 annex D.

We do not recommend the use of an inline LPG BBQ with the 1.2kg/H regulator when other LPG appliances are in use.

**Warning:** Unless en-route heating is in use the LPG cylinder valve should be closed when driving.

REGULATOR for systems NOT approved for use when travelling. (Fig 2)



Fig. 2

**Note:** The regulator valves should be in the 'OFF' position when driving.

**Note:** No safety device on this system

#### Gas Hoses

High-pressure hoses or pigtails as they are called must be used with the new style regulator.

High-pressure hoses incorporate a safety shut off valve for the use of the en-route heating system

LPG bottle i.e. Propane, Butane, BP and Camping Gaz cylinders all have unique bottle adaptor connections. It is important to check

you have the correct hose and adaptor to suit your gas bottles.

Push on hoses are no longer permitted under the latest regulations.

The new high-pressure hoses have threaded connections and must be securely attached to the regulator and to the gas bottle.

Ensure that there is a constant rise in the flexible gas hose between the gas bottle outlet and the regulator elbow.

**WARNING:** Inspect flexible gas hose(s) regularly for deterioration and renew as necessary with the approved type, in any case no later than 5 years after the date of manufacture marked on the hose.

When replacing the en-route hose ensure the new hose incorporates a safety shut off valve (Hose rupture protection)

**WARNING:** Ensure hoses do not become entangled in door mechanism.

**WARNING:** Always ensure the gas supply is isolated at the LPG cylinder (and not at the regulator) whilst the vehicle is in storage for any period. It is important to ensure that the high pressure gas hose has a continuous rise from the bottle cylinder to the regulation to allow any condensate to fall back into the gas bottle cylinder.

#### Cylinder compartment

All cylinder compartments have four plastic mouldings per cylinder position fitted to the floor of the compartment that are designed to fit both steel and BP Gas Light cylinders. Two straps are provided for retaining the bodies of the cylinders at mid to high level.

## TYPES OF GAS

### Propane

Propane is supplied in red, or partly red bottles which have a female left hand threaded connector.

Scandinavian countries use the same connector.

Germany and Austria supply propane with a male connection.

Propane will work at temperatures as low as -40°C and is therefore suitable for all winter motorhoming.

**Note: Swift recommend that 6kg CalorLite propane gas bottles are used.**

### Butane

Butane is supplied in the U.K. in green or blue bottles.

All these have a male left hand thread

EXCEPT for Camping Gaz which has a special female right hand thread and Calor 7kg and 15kg and aluminium bottles which have a special clip-on connection.

Continental bottles usually have a male left hand thread similar to but not identical with U.K. butane.

Butane is only suitable for use at temperatures down to 2°C but will not work below that.

**Note:** A hose suitable for use with propane has been supplied with your motorhome.

## EN-ROUTE HEATING

The majority of Swift Group motorhomes are equipped with an LPG en-route heating system. The en-route heating system is installed with additional safety features.

**WARNING:** when re-fuelling your motorhome, switch off the heater and close the cylinder valve.

### Safety features

- MonoControl CS regulator incorporating a crash sensor which stops the gas flow in the event of the motorhome being involved in a traffic collision.
- Gas flow monitor
- Hose rupture protection is installed.

The full system is Homologated in compliance with European Directive 2001/ 56/ EC,

### Operating instructions

Priming the gas system

- Open the cylinder's valve. (1)
- Firmly press the hose rupture protection (green button) on the high pressure hose. (2) If necessary (e.g. if the regulator has been knocked when replacing a LPG cylinder) press the green reset button on the regulator. (3)
- Start the gas-burning devices if desired. If the gas cylinders are closed.

**Note:** The regulator should be replaced no more than ten years after manufacture.

### Changing a gas cylinder

Please use the correct size spanner for the gas hose connectors as this will prevent damage to the screw fittings and ensure that the fitting is tightened sufficiently.

- Close the empty gas cylinder's valve
- Remove the high pressure hose from the gas cylinder.

- Attach the high pressure hose to the full gas cylinder.
- Open the full cylinder's valve.
- Press the hose-break safety device and the gas-flow monitor (see: Priming the gas system).

Check the hose connection to the cylinder valve for leaks.

**WARNING:** To ensure the safe working of the en-route heating any replacement high pressure hoses must be of the same type as originally fitted. They must have the safety valve to ensure that the gas does not leak out in the event of damage to the gas pipe work in the event of a traffic collision.

**WARNING:** When travelling using the en-route system all other LPG appliance shut off valves must be in the closed position including the fridge, cooker, water heater etc.

**Note:** It is dangerous and illegal to operate other LPG appliances whilst travelling

Service and repairs must only to be carried out by a competent service engineer.

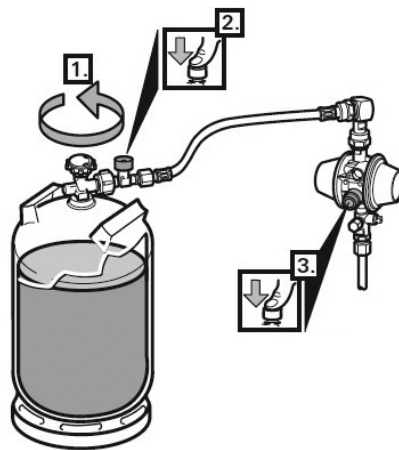

## GAS SAFETY ADVICE

**WARNING:** If you smell gas or suspect a leak or in the event of a fire and if it is safe to do so, isolate the gas appliances and turn off the gas bottles at the regulator. Evacuate the motorhome and ventilate. Seek professional advice as to the cause of the leak.

### Facts about LPG

- LPG is not poisonous.
- Bi-products are harmless.
- There is danger if all air and oxygen were excluded.
- (Ventilation holes must be kept clear at all times).
- LPG has been given a smell by the manufacturers in order to identify leaks.

### Awning Spaces LPG Appliance Exhaust

There is no danger of pollution of an enclosed awning space by the LPG exhaust from a refrigerator venting into it, as awning spaces are generally well ventilated.

Space heaters may produce sufficient exhaust to pollute the awning space, if it is totally enclosed, from a general comfort, smell and hygiene point of view. In the extreme case there could be a build up of carbon dioxide to a dangerous level.

Motorhome owners are advised to allow some fresh air circulation in the awning space when such appliances are in use.

### General Safety Notes

In the event of leaks in the gas system or if there is a smell of gas:

- Extinguish all naked flames.
- Do not smoke.
- Switch off the appliance and gas cylinder.
- Open the windows.
- Do not operate any electrical switches.

- Have the entire system checked by an expert.

### Precautions

- Never look for a leak with a match. Always use a soap solution or its equivalent when testing connections. Do not operate any electrical apparatus whatsoever, especially light switches. If the leak is not obvious, the motorhome should be evacuated and qualified personnel consulted.
- Avoid naked lights when connecting or changing a cylinder.
- Check the flexible hose frequently.
- The gas is heavier than air and therefore sinks to the lowest point.
- Keep bottle gas containers outside (and protected against frost). If they must be kept inside make sure they are well away from heat.

**WARNING:** Do not use appliances with a different working pressure to 30mbar.

**WARNING:** Maintain adequate spacing of combustible materials from sources of heat.

**WARNING:** Do not use independent portable gas appliances inside the vehicle. Cookers shall not be used as heaters

**WARNING:** A BBQ point inlet valve, if fitted, must only be used for the connection of portable LPG appliances.

### Always read individual appliance instructions

### Connection

Ensure that the gas regulator hose is correctly connected to the gas cylinder in gas bottle compartment and that the hose connection is tight.

Gas bottles must be fully located, seated at the base of the bottles and restrained by the

straps provided in the dedicated compartment position. Straps are positioned to suit 6kg, 7kg and 13kg bottles.

**WARNING:** If using cylinders other than those recommended, the user must ensure these are adequately supported, ventilation openings must not be obstructed and the cylinders must not cause damage to other fixtures and fittings located in the compartment.

Open ended gas hoses must always be protected from dirt and insects.

Before turning on the gas supply at the regulator, ensure that all gas operated equipment in the motorhome is turned off.

All gas equipment is supplied through a Gas Manifold System which has individual isolation taps for each appliance (Fig A), as follows:

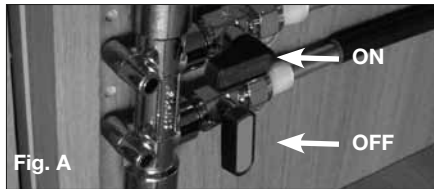

- RED - Water Heater / Combination boiler
- WHITE - Space Heater
- BLUE - Fridge
- GREEN - Oven

**Ventilation**

All ventilation complies with BSEN 721 and vents should not be obstructed in any manner as this could lead to insufficient fresh air. In this case the confined atmosphere becomes depleted of oxygen which leads to the formation of the highly poisonous gas 'carbon monoxide'. Carbon Monoxide is odourless,

colourless and tasteless and will rapidly cause unconsciousness and death with little or no warning prior to collapse.

THERE IS NO DANGER WHEN ADEQUATE VENTILATION IS PROVIDED. KEEP SCREENS OR GRILLS CLEAN AND FREE FROM DUST

**Roof-mounted Flue installations**

All flue installations should be inspected once a year throughout their length for corrosion. Flues should be replaced if any sign of perforation is found. Ensure that the replacement is of an approved type.

**Thermal insulation heating**

Your motorhome has been designed to achieve a thermal insulation and heating level for specific climatic conditions when tested according to the procedure in EN1646-1. See the motorhome technical book for the classification of your motorhome.

The classifications are as follows:

**Grade 1**

A motorhome with an average thermal transmittance (u) that does not exceed 1.7w/(m2k).

**Grade 2**

A motorhome with an average thermal transmittance (u) that does not exceed 1.7w/(m2k) and which can achieve an average temperature difference of at least 20k between inside and outside temperatures when the outside temperature is 0°C.

**Grade 3**

A motorhome with an average thermal transmittance (u) that does not exceed 1.2w/(m2k) and which can achieve an average temperature difference of at least 35k between inside and outside temperatures when the outside temperature is -15°C.

**GAS**

Fault	Cause	Remedy
Hob does not light	No gas	Check level of gas in bottle Check gas bottle valve is on Check gas taps are on
	Air in pipe	Purge system Refer to hob manufacturers instructions
Oven does not light	No gas	Check level of gas in bottle Check gas bottle valve is on Check gas taps are on
	Air in pipe	Purge system Refer to oven manufacturers instructions
Space heater	No gas	Check level of gas in bottle Check gas bottle valve is on Check gas taps are on Check exhaust outlet is clear
	Over gassed Air in pipe	Turn off appliance, wait 2 minutes and try again Purge system Refer to space heater or boiler manufacturers instructions
Fridge does not light	No gas	Check level of gas in bottle Check gas bottle valve is on Check gas taps are on
	Air in pipe	Purge system Refer to fridge manufacturers instructions
Water heater does not light	No gas	Check level of gas in bottle Check gas bottle valve is on Check gas taps are on
	Air in pipe	Purge system Refer to water heater manufacturers instructions

## THE ELECTRICAL SYSTEM

### General Information

It is strongly advised that the mains installation is inspected periodically to ensure safe use. The IET (BS7671) wiring regulations recommend that mains installations in motorhomes are re-inspected every 3 years or annually if the van is used frequently. The National Caravan Council lists the qualifications necessary to perform this inspection, but an NICEIC approved contractor is probably the first choice.

### On arrival at the campsite

- Check the suitability of the supply, is it AC or DC, is the voltage and frequency correct.
- Ensure that there is a proper earth (3 pin socket outlet).
- If in doubt consult site staff.
- Make sure that the supply from the site is switched off.
- Make sure that the charger switch on the PSU is switched off.
- Lift the cover on the electricity inlet on the motorhome, and insert the connector on the flexible supply cable.
- At the site supply point, connect the other end of the supply cable to this using the socket provided.
- Switch on the main switch at the site supply point.

**CARE POINT:** It is good practice to test the RCD (Residual Current Device) in the PSU before switching on. There is a test button on the RCD to test the lever, put the lever in the up position (on) before testing.

**CARE POINT:** As with the RCD it is good practice to check the Miniature Circuit Breaker (MCB) in the PSU. Switch all to the on position (lever up). If any do not stay up then there is a fault.

On departure from the campsite

- Switch off supply from the site, disconnect the cable at both ends.
- Switch off RCD.

**Note:** never use a mains supply lead whilst coiled. Always uncoil the full length before connecting to the supply and remember to protect the cable from traffic.

**WARNING:** current consumption in the motorhome must not exceed 16 amps or the pitch permitted maximum if this is less than 16 amps.

### OVERSEAS CONNECTION

- Connection to a mains voltage overseas requires particular attention.
- Overseas supplies can be of reverse polarity.
- Reverse polarity results in equipment not necessarily being isolated when turned off, reverse polarity indicator on the PSU will light in the event of reverse polarity.
- The only sure way to make equipment safe is to unplug it.
- It is useful to have a means of checking polarity when overseas.
- If it can be achieved then connect live to live, and neutral to neutral to achieve full electrical protection.

**WARNING:** Never allow modifications of electrical or LPG systems and appliances except by qualified persons.

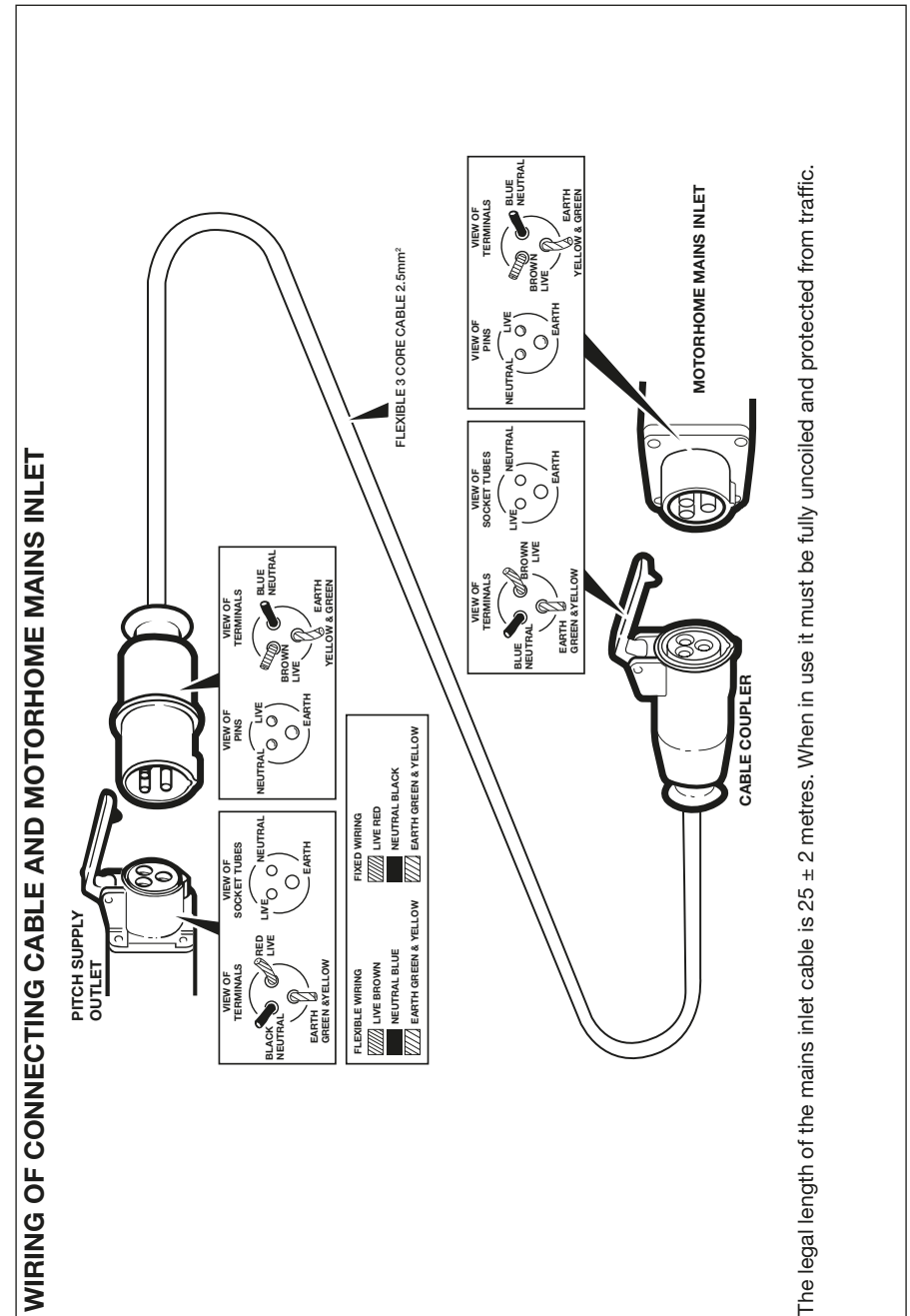

The legal length of the mains inlet cable is 25 ± 2 metres. When in use it must be fully uncoiled and protected from traffic.

## 230V MAINS ELECTRICAL EQUIPMENT

## 230V MAINS ELECTRICAL EQUIPMENT POWER CONSUMPTION

**Note:** It is possible that the 230v mains electrical equipment may not all operate simultaneously. A typical UK site mains hook up point provides a maximum output of 10 amps and on some continental sites the available output may be as low as 5 amps. If your loading exceeds the site supply it may trip the site circuit breaker. Please check the available mains supply with your site operator.

Similarly loadings on each circuit breaker within the motorhome should be observed. A label positioned close to the MCB's (Miniture Circuit Breakers) will identify which appliances within the motorhome are fed from which MCB. Consulting the typical appliance consumption figures table in conjunction with this label, will give an indication of which appliances can, and cannot, (site supply allowing), be operated simultaneously.

## APPLIANCE CONSUMPTION FIGURES

### TYPICAL APPLIANCE CONSUMPTION FIGURES

Appliances	230V		12V Watts	Amperes	LP GAS Grams/hour
	Watts	Amperes			
Theftord Refrigerator	140 / 200 W	0.6 amp / 0.9 amp	Only when driving		13 g/h
Waeco Refrigerator or freezer box	Not Applicable		Max 45 W	3.8 amp (max)	Not Applicable
Truma Combi 4kw Heating system	900/1800 W	3.9/7.8 amp	13 W	1.1 amp (avg)	160-320 g/h
Truma Combi 6kw Heating System	900/1800W	3.9/7.8 amp	16 W	1.3 amp (avg)	160-480 g/h
Aide 3010 Heating System	1050/2100/3150 W	4.6/9.1/13.7 amp	12 W	1.0 amp	245-460 g/h
Truma Space Heater	500/1000/2000 W	2.2/4.3/8.5 amp	12 W	1.0 amp	30 to 280 g/h
Truma Ultrastore Water Heater	850/1300 W	3.7/5.6 amp	Not Applicable	Not Applicable	120 g/h
Microwave (factory fit)	1000 W	4.3 amp	Not Applicable	Not Applicable	Not Applicable
Cooker - Hob burners	Not Applicable		Not Applicable	Not Applicable	70-161 g/h
Cooker - Electric Hotplate	850 W	3.7 amp	Not Applicable	Not Applicable	Not Applicable
Grill	Not Applicable		Not Applicable	Not Applicable	117 g/h
Oven	Not Applicable		Not Applicable	Not Applicable	125 g/h
Battery Charger	690W	3.0 amp	Not Applicable	Not Applicable	Not Applicable
12v Halogen Lighting (based on 10W/bulb)	Not Applicable		10 W	0.8 amp	Not Applicable
Water tank frost element (Winter pack)	Not Applicable		30 W	2.5 amp	Not Applicable

**Note:** These are approximate figures for guidance only.

SERVICES



EC400 Series Power control system .....	64
Control Panel System Operation .....	67
Battery charger .....	69
Fuses .....	71
Electrical faults .....	75
Motorhome Battery .....	80
Thetford battery box .....	81
Solar panel connection point .....	82
Accessory Harnessing .....	83
Generator usage .....	83
Habitation relay .....	84
Fault finding .....	85

## EC400 SERIES POWER SUPPLY SYSTEM

## EC400 SERIES POWER CONTROL SYSTEM

### 1. Introduction

This section of the handbook will guide you through the operation of the electrical system. Further technical details are contained in section 3 or in the supporting dealer technical manual available from [www.sargentltd.co.uk](http://www.sargentltd.co.uk)

For the safe operation of all electrical equipment within your Leisure Vehicle it is important that you read and fully understand these instructions. If you are unsure of any point please contact your dealer / distributor for advice before use.

The system has a number of key components that you will need to be familiar with before attempting to use the system, these are:

- **The EC400 series Power Supply Unit (PSU)** - a combined mains consumer unit and 12V controller located in the front locker or bed box area. The EC400 series of power supply units include horizontal units and vertical units, further details are contained later in this document.
- **The EC400 series Control Panel (CP)** - a remotely located user control panel used to turn circuits on and off and to display battery and water tank information. This panel uses simple straight forward controls and reliable data communication to the PSU.

### 2 Using the System

The PSU is located in the front offside locker area or front bed box in motorhomes.

### 2.1 Power Supply Unit - Models

A number of different PSU versions are used within the system. The operation of each model is very similar and is detailed below.



230V Components	
	Red indicator – Reverse polarity indicator, lights up when the 230V supply polarity is reversed.
	Green push switch – Charger switch, this switch turns the 12V battery charger on or off. “In” is on “out” is off.
	Amber push switch – Space heater switch, this switch turns the 230V supply to the space heater / combination heater / central heating system on or off. In is on out is off.
	Clear push switch – Water heater switch, this switch turns the 230V supply to the separate water heater on or off. In is on out is off. <b>Note, If the vehicle contains a combined space &amp; Water heater then this button is not used.</b>
	Black lever switch, far left – Residual Current protection Device (RCD) and main 230V on / off switch.
	Yellow button, far left – RCD test button.
	Red lever switches, right – 3 x 10A Miniature Circuit Breakers (MCB). Please note that installations with a 3KW Alde heating system will have 2 x 10A and 1x16A MCB's.
12V Components	
	Black push switch, far left – System shutdown switch, this switch turns the power control system on or off. In is on out is off.
	Yellow push button, top right – Select button, this button is used to scroll through the display items on the LCD screen.
	Red push button, bottom right – Set button, this button is used to change the setting of the displayed item on the LCD screen.
	12V DC circuit protection fuses. Fuse number 1 is top left; Fuse number 14 is bottom, right. See section 3.5 for full fuse allocation details.

### 2.3 Activating the System

The EC400 system has a shutdown feature that should be used when the vehicle is in storage or is not being used for long periods of time. This allows the leisure electronics to be turned off when not required to save battery power. When in the off state the alarm and tracking system supplies are still active, most other supplies are turned off.

Before using the system please ensure the shutdown switch is in the system on position (button in).

### 2.4 Connecting to the Mains 230V supply and Safety checks

For your safety it is IMPORTANT that you follow these connections instructions each time your Leisure Vehicle is connected to a mains supply. This section assumes that the system is complete and that a Leisure battery has been installed (see 3.4).

- A) **Ensure suitability of the Mains Supply.** Your Leisure Vehicle should only be connected to an approved supply that meets the requirements of BS7671 or relevant harmonised standards. In most cases the site warden will hold information regarding suitability of supply. If using a generator you also need to comply with the requirements / instructions supplied with the generator.

Please note that some electronic generators may not be compatible with your leisure system. Further generator operational information is contained elsewhere in this manual.

- B) **Switch the PSU internal Power Converter OFF.** Locate the green 'Charger' power switch on the PSU and ensure the switch is in the off position (button out) before connection to the mains supply.
- C) **Connect the Hook-up Lead.** Firstly connect the supplied hook-up lead (orange cable with blue connectors) to the Leisure Vehicle and then connect to the mains supply.

- D) **Check Residual Current Device operation.** Locate the RCD within the PSU and ensure the RCD is switched on (lever in up position). Press the 'Test' button and confirm that the RCD turns off (lever in down position). Switch the RCD back to the on position (lever in up position). If the test button failed to operate the RCD see section 3.10.
- E) **Check Miniature Circuit Breakers.** Locate the MCB's within the PSU (adjacent to the RCD) and ensure they are all in the on (up) position. If any MCB's fail to 'latch' in the on position see section 3.10.
- F) **Turn the PSU ON.** Locate the black 'Shutdown' button and ensure it is in the on position (press button in). Locate the green 'Charger' switch on the PSU and turn to the on position (press button in). The charger switch will illuminate when turned on.
- G) **Check correct Polarity.** Locate the 'Reverse polarity' indicator on the PSU and ensure that the indicator is NOT illuminated. If the indicator is illuminated see section 3.10.
- H) **Check operation of equipment.** It is now safe to operate the 12v and 230v equipment.

### 2.5 Control Panel - Component Layout

Depending on your type of vehicle (caravan or motorhome) the control panel will vary in specification.

Not all features are present in all vehicles. Please refer to the following diagrams to identify your control panel.

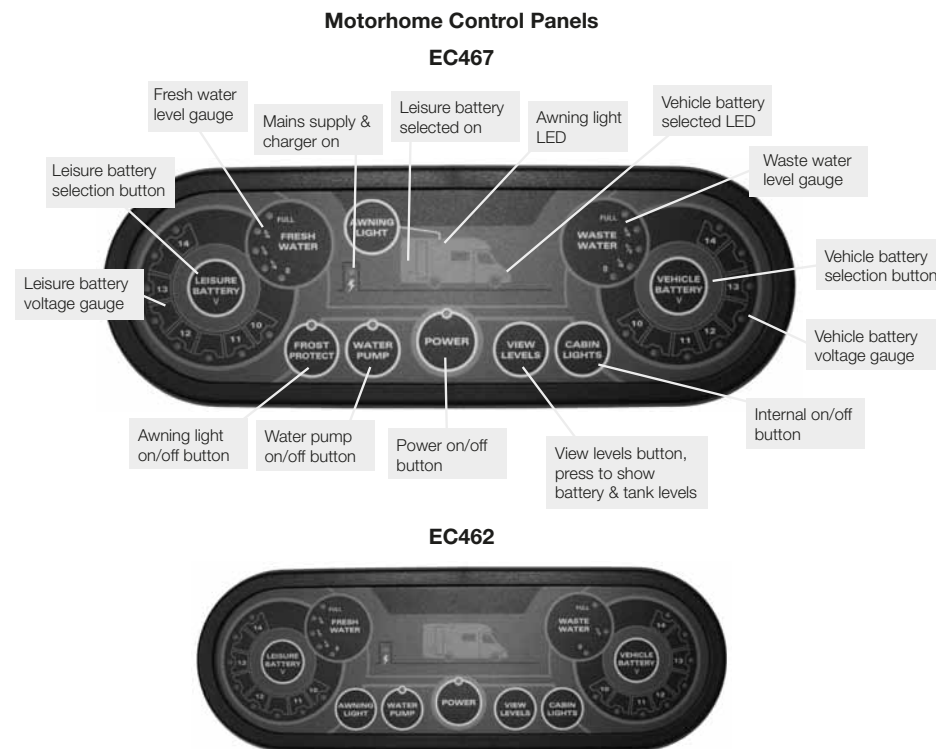

### 2.6 Control Panel Operation

- **Power Button.** Press the power button to turn the leisure power on. Press the button again to turn the power off. The adjacent LED will illuminate when the power is on, and also the voltage of the selected battery will be displayed on the voltage gauge.
- **Pump Button.** With the power on, press the pump button to turn the water pump on. Press the button again to turn the pump off. The adjacent LED will illuminate when the pump is on, and also the level of the water tank will be displayed on the water gauge.
- **View Levels.** To display the battery voltage levels and the water tank levels on the control panel gauges, press the levels button. The display will remain illuminated for 10 seconds. It is possible to lock the display 'on' to allow continuous display. This can be achieved by pressing and holding the view levels button for 2-3 seconds until you hear a beep. To turn this locked feature off, either press and hold the view levels button again for 2-3 seconds or turn the power off and back on.
- **Battery Select.** By default, the leisure battery is selected as the power source if no mains supply is present, or as the battery to be charged when the mains supply is available. To change the selected battery, press the vehicle battery select button. The selected battery is indicated by the LED's situated to the front (vehicle) or rear (leisure) of the motorhome logo
- **Mains on indication.** When connected to a 230v supply the LED with a "lightning strike" shown will be illuminated.

- **Charging when the vehicle engine is running.** When the vehicle engine is running both the vehicle battery and the leisure battery LED's will flash in unison to indicate that they are connected together and are being charged by the vehicle.
- **Cabin Lights Button.** For motorhomes, with the power on, press the cabin lights button to turn the main lighting supply on or off.
- **Awning Light Button.** For motorhomes, with the power on, press the awning light button to turn the awning light on or off.
- **Frost Protect Button.** For motorhomes if / when fitted, with the power on, press the frost protect button to turn on the water tank heating system. The adjacent LED will illuminate to show that the tank heating system is on.

## 2.7 Operation while driving

The EC400 system is designed to shutdown parts of the system while the engine is running. This is to meet Electro Magnetic Compatibility (EMC) regulations and to ensure the safe operation of the caravan or motorhome. This is indicated by the two battery LED's flashing together.

Please ensure the system shutdown switch on the PSU is in the "on" (button in) position before driving (see 2.3). This will ensure the electronic system is active and will therefore be able to control the charging process, supply the refrigerator and monitor other system circuits.

On motorhomes if / when fitted, designated 12v sockets, en-route reading lights and en-route heating will remain operational while the engine is running.

## 3 System Technical Information

The following section provides further technical information relating to the electrical system. You can also access the supporting technical manual from [www.sargentltd.co.uk](http://www.sargentltd.co.uk)

### 3.1 Residual Current Device & Miniature Circuit Breakers

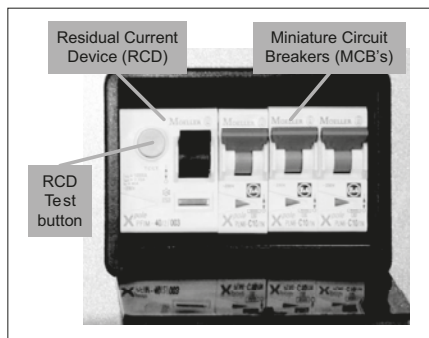

The Residual Current Device (RCD) is basically provided to protect the user from lethal electric shock. The RCD will turn off (trip) if the current flowing in the live conductor does not fully return down the neutral conductor, i.e. some current is passing through a person down to earth or through a faulty appliance.

To ensure the RCD is working correctly, the test button should be operated each time the vehicle is connected to the mains supply (see section 2.4)

The Miniature Circuit Breakers (MCB's) operate in a similar way to traditional fuses and are provided to protect the wiring installation from overload or short circuit. If an overload occurs the MCB will switch off the supply. If this occurs you should investigate the cause of the fault before switching the MCB back on.

The following table shows the rating and circuit allocation for the three MCB's

MCB	Rating	Output wire colour	Description
1	10 amps	White	230v Sockets
2	10 amps	White (Yellow for heater)	Extra 230v Sockets / Space Heater
2	16 amps	Yellow	Alde heating (EC470 PSU Only)
3	10 amps	Black (Blue for water heater)	Fridge / Water Heater / 12v Charger (internally connected)

### 3.2 Battery Charger

The EC400 system incorporates an intelligent three-stage battery charger / power converter. During stage 1 the battery voltage is increased gradually while the current is limited to start the charging process and protect the battery. At stage 2 the voltage rises to 14.4V to deliver the bulk charge to the battery. When the battery is charged, the voltage is decreased at stage 3 to 13.6V to deliver a float charge to maintain the battery in the fully charged state. The charger can be left switched on continuously as required.

The battery charger / power converter also provides power to the leisure equipment when the mains supply is connected. This module supplies DC to the leisure equipment up to a maximum of 25 Amps (300 Watts), therefore the available power is distributed between the leisure load and the battery, with the leisure load taking priority as per the following example:

Leisure Load	Available power for battery charging
5A	20A
10A	15A
15A	10A
20A	5A

**WARNING:** Under heavy loads the Charger case may become hot. ALWAYS ensure the ventilation slots have a clear flow of air. Do not place combustible materials against / adjacent to the Charger

### 3.3 Smart Charging

On EC468 and EC469 PSU's, the system incorporates a smart charge feature, which monitors both leisure and vehicle batteries and automatically adjusts and directs the charger power (and solar power if a solar panel is installed) to maintain the leisure and vehicle batteries at an optimal level.

### 3.4 Leisure Battery

#### A) Type / Selection

For optimum performance and safety it is essential that only a proprietary brand LEISURE battery is used with a typical capacity of 75 to 120 Ah (Ampere / hours). A normal car battery is NOT suitable.

This battery should always be connected when the system is in use. The PSU is configured to work with standard lead acid leisure batteries, and in most cases is also compatible with the latest range of Absorbed Glass Matt (AGM) batteries. Before fitting non-standard batteries please check that the charging profile described in 3.2 is suitable for the type of battery by referring to the battery documentation or battery manufacturer.

## EC400 SERIES POWER SUPPLY SYSTEM

Some vehicle installations can cater for two leisure batteries connected in parallel. In these cases it is recommended that two identical batteries are used.

The battery feed is fitted with an inline fuse between the battery and the electrical harness, and is usually located immediately outside the battery compartment or within 500mm of the battery. The maximum rating of this fuse is 20A per battery. If a single battery is fitted to a motorhome, this fuse may be increased to 40A, however if two batteries are fitted each battery should be fused at a maximum of 20A.

### B) Installation & Removal

Always disconnect the 230v mains supply and turn the PSU green charger switch to the off position (button out) before removing or installing the battery.

When connecting the battery, ensure that the correct polarity is observed (black is negative [-] and red is positive [+]) and that the terminals are securely fastened. Crocodile clips must not be used.

**WARNING:** Explosive gases may be present at the battery. Take care to prevent flames and sparks in the vicinity of the battery and do not smoke.

### C) Operation / Servicing

Under normal circumstances it should not be necessary to remove the battery other than for routine inspection of the terminals and “topping up” of the battery fluid where applicable. Please see instructions supplied with the battery.

**Note:** Do not over discharge the battery. One of the most common causes of battery failure is when the battery is discharged below the recommended level of approximately 10v. Discharging a battery below this figure can cause permanent damage to one or more of the cells within the battery.

To prevent over discharge, the EC400-450 system incorporates a battery protect circuit that warns the users and then disconnects the batteries when they fall below set values.

If the power is turned on and the leisure battery level falls below 9V a warning beep will be heard and the leisure battery gauge 10V LED will flash. To cancel the warning, press the levels button.

If the power is turned on and the vehicle battery level falls below 10.9V a warning beep will be heard and the vehicle battery gauge 10V LED will flash. To cancel the warning, press the levels button.

These warnings will not be repeated unless the power switch is turned off and on again. This is to ensure the warning does not become a nuisance.

Battery	Voltage cut off	Action after cut off	Notes
Vehicle	10.9v	Battery selection is changed from Vehicle battery to Leisure battery. If the leisure battery is below 9v then a further warning will occur (see below).	This cut off level is designed to protect the vehicle battery from over discharge. The 10.9v level ensures there is sufficient power in the battery to run the vehicle electronics and start the vehicle. This cut off only applies to power drawn from the battery by the leisure equipment; it will not protect the battery if you leave vehicle circuits switched on, such as the road lights.
Leisure	9v	Power is turned off	This is an emergency cut off level to protect the battery from severe damage. You should not rely on this cut off level during normal operation, but manage your power consumption to a discharge level of 10v.  This cut off only applies to power drawn from the battery by the leisure equipment that is controlled by the control panel power switch; it will not protect the battery from discharge by permanently connected equipment.

### 3.5 12 Volt DC Fuses

**WARNING:** When replacing fuses always replace a fuse with the correct value. NEVER replace with a higher value / rating as this could damage the wiring harness. If a replacement fuse ‘blows’ do not keep replacing the fuse as you could damage the wiring harness. Please investigate the fault and contact your dealer.

## EC400 SERIES POWER SUPPLY SYSTEM

The following table shows the fuse allocation for the 15 fuses fitted to the PSU. Please note that fuses are dependant on PSU versions, so not all fuses may be present.

Fuse	Rating	Fuse colour	Description
1	20 Amps	Yellow	* Motorhome Fridge 12V
2	15 Amps	Blue	* Motorhome Towing
3	7.5 Amps	Brown	* Motorhome Marker Lights
4	15 Amps	Blue	* Motorhome Fridge D+
5	10 Amps	Red	Extractor Fans / Heating Systems
6	10 Amps	Red	12V Sockets / TV Amp / ***Radio
7	10 Amps	Red	Front Internal Lights
8	10 Amps	Red	Water Pumps / Toilet
9	15 Amps	Blue	* Electric Step
10	10 Amps	Red	* Motorhome Tank Heaters
11	10 Amps	Red	** Auxiliary Supplies
12	5 Amps	Tan	Electronics / Fridge / Alarm
13	5 Amps	Tan	Oven Ignition / * Water Heater
14	10 Amps	Red	Rear Internal Lights
15	25 Amps	Clear	Charger (fitted internally to PSU)

\* Where Applicable / When Fitted

\*\* Motorhome Awning / Entry lights / Map lights / Enroute Heating / Compressor Fridge / Travel Skts / Bathroom lights

\*\*\* Caravan Radio Supply / Motorhome Bathroom lights

The following table shows details of the fuse(s) located at the Leisure battery. See also 3.4A

Fuse	Rating	Fuse colour	Description
Battery 1	20 Amps	Yellow	Fuse remotely located near battery
Battery 2	20 Amps	Yellow	Fuse remotely located near battery 2 (where fitted)

The following table shows details of the fuse(s) located at the Road Light fuse box (caravans only)

Fuse	Rating	Fuse colour	Description
1	20 Amps	Yellow	Fridge Supply 12V
2	5 Amps	Tan	Left Hand Tail Lights
3	5 Amps	Tan	Right Hand Indicators
4	5 Amps	Tan	Fog Lights
5			Spare location
6	20 Amps	Yellow	Car Battery Supply 12V
7	5 Amps	Tan	Right Hand Tail Lights
8	5 Amps	Tan	Left Hand Indicators
9	7.5 Amps	Brown	Stop Lights
10	5 Amps	Tan	Reverse Lights

### 3.6 Solar Charge Management

EC468 and EC469 PSU's incorporate a built-in solar charge management feature, which will control the input from a separate solar panel and regulator. Depending on the charge state of the batteries, the solar power will be directed to the required battery, and continuously monitored to ensure optimum operation. For this system to operate intelligently, the shutdown button should be left switched on. If the shutdown button is turned off then the solar panel will charge the vehicle battery only.

### 3.7 System Status and Configuration display

On the 468 & 469 PSU, the unit contains an LCD display and two control buttons that allow system information to be viewed or settings changed.

Press the top yellow 'select' button to change the item being viewed. Press the bottom red 'change' button to change the setting. Both buttons work on a continuous loop, so if you want to return to an item or setting keep pressing the button until the required item is reached. The EC468 and EC469 PSU's also contain

a status display unit that can be used to view system information. Press the top yellow 'select' button to change the item being viewed.

### 3.8 Water System Operation

The control panel pump button operates the internal (onboard) water pump. This pump will draw water from the internal (onboard) water tank.

The system also incorporates a separate powered water inlet that can be used with an external filler pump to fill the internal (onboard) water tank.

The water tanks (fresh & waste, where fitted) incorporate a level warning feature to warn the user when the fresh water level drops below 25% or when the waste water level reaches 100%. If the water pump power is turned on and the fresh water level drops to below 25% a warning beep will be heard and the fresh gauge empty LED will flash. To cancel the warning, press the levels button.

If the water pump power is turned on and the waste water level rises to full (100%) a warning beep will be heard and the waste gauge full LED will flash. To cancel the warning, press the levels button. These warnings will not be repeated unless the water pump power switch is turned off and on again. This is to ensure the warning does not become a nuisance.

**3.9 Frost Protection**

On vehicles fitted with water tank frost protection, the control panel frost protect switch can be used to turn the feature on or off.

With protection on, the system monitors the tank water temperature and water level and will control the tank heaters accordingly. If the fresh or waste water levels are less than 25% the appropriate heater will be turned off to prevent overheating or damage to the element.

There are two types of system employed, both working in a very similar way. One system uses heaters with built-in thermostats; the other uses separate temperature probes in the tank. Both types switch on at 4-5°C and off at 8-10°C

**3.10 Electric Step Operation**

On vehicles fitted with an electric step, this is operated by a button near the entry door. Press and release the button to move the step in or out. One press of the button will move the step out, a further press will move the step in again. If the engine is started the step will move in automatically, after a short warning buzzer. If this operation fails due to an obstacle a buzzer will sound continuously to warn that the step is still out, and therefore requires your attention.

**3.11 Warnings and Alerts**

If the vehicle engine is started whilst the motorhome is connected to the 230v supply, a warning beep will be heard. This is to warn you to remove the 230v supply before driving away.

When the vehicle engine is running both the vehicle battery and the leisure battery LED's will flash in unison to indicate that they are connected together and are being charged by the vehicle.

Step operation, if the engine is started with the step in the out position, the step will move in automatically, after a short warning buzzer. If this operation fails due to an obstacle a buzzer will sound continuously to warn that the step is still out, and therefore requires your attention.

Low water level and waste tank, if the fresh water level drops to below 25% a warning beep will be heard and the fresh gauge empty LED will flash. To cancel the warning, press the levels button. If the waste water level rises to full (100%) a warning beep will be heard and the waste gauge full LED will flash. To cancel the warning, press the levels button.

Low voltage warning and cut off, if the power is turned on and the leisure battery level falls below 9V a warning beep will be heard and the leisure battery gauge 10V LED will flash. To cancel the warning, press the levels button. If the power is turned on and the vehicle battery is selected (being used) and the level falls below 10.9V a warning beep will be heard and the vehicle battery gauge 10V LED will flash. To cancel the warning, press the levels button.

**3.12 Common Fault Table**

Fault	Possible Cause	Proposed Fix
No 230 volt output from PSU	Connecting lead between the site and Leisure Vehicle not connected	Check and connect lead as per 2.4C
	RCD switched off	Reset RCD as per 2.4D
	RCD not operating correctly	Check supply polarity; if the RCD continues to fail contact your Dealer as there is probably an equipment or wiring fault.
	MCB switched off	Reset MCB by switching OFF (down position) then back ON (up position), if the MCB continues to fail contact your Dealer as there is probably an equipment or wiring fault.
	No or deficient supply from site	Contact site Warden for assistance
Reverse Polarity light is illuminated on PSU	Other fault	Contact your Dealer
	Mains Supply reversed?	The reverse polarity light is designed to illuminate when the Live and Neutral supply has been reversed / crossed over. If the light illuminates there is a problem with the site supply or the cable connecting the supply to your vehicle. The light is designed to work on UK electrical supplies (where the neutral conductor is connected to earth at the sub station). If you are using your vehicle outside the UK this light may illuminate when no fault exists. In these cases consult the site warden for advice.

**3.12 Common Fault Table**

Reverse Polarity light is illuminated on PSU	Generator being used	'The Reverse Polarity warning light is on when using my Generator'. This is a normal side effect when using some types of generator. Instead of connecting the neutral conductor to earth, some generators centre tap the earth connection making both neutral and live conductors 110v above earth. This 110v difference causes the neon polarity indicator to illuminate. In most cases it is still safe to use the generator, but please consult the generator handbook for further information.
Control Panel Problems	Control Panel has no display	Check batteries and fuses, turn PSU shutdown switch and charger switch on and ensure mains supply is connected. Check control panel connecting lead at PSU and behind Control Panel. Contact your Dealer
	12v Power turns off	Battery protect feature has operated to protect the Vehicle battery and or the Leisure battery. See 3.4C  Engine has been started, all equipment has been disconnected to meet EMC requirements. See 2.7
	Control Panel locked / erratic function	Observe control panel handling instructions  Control panel software may have crashed. Reboot control panel by turning off the PSU isolate switch. Wait 30 seconds then turn the switch back on.

No 12 volt output from PSU	No 230v supply	Check all above
	Charger not switched on	Turn charger switch on, switch will illuminate
	Battery not connected and / or charged	Install charged battery as per 3.4
	Power button on control panel not switched to on	Turn power on at control panel
	Battery flat / Battery fuse blown	Recharge battery, check fuses, check charging voltage is present at battery
	Fuse blown	Check all fuses are intact and the correct value fuse is installed as per fuse table
	Equipment switched off / unplugged	Check equipment is switched on and connected to the 12v supply
	PSU overheated / auto shutdown operated	Reduce load on system. Allow PSU to cool down. PSU will automatically restart when cool.
Pump not working	Other fault	Contact your Dealer
	Fuse blown	Replace fuse with correct value as per fuse table.
	Pump turned off	Turn pump on by pressing the pump button at the control panel.
	Setting incorrect	Both the internal and external pump feeds are controlled from the control panel. To alter the setting of the pump switch see section 3.8  Ensure the setting matches your desired requirement.

**3.13 Contact details**

Sargent Electrical Services Limited, provide a technical help line during office hours. Please contact 01482 678981 if you require technical help. For out of hour support please refer to the tech support section of the Sargent web site [www.sargentltd.co.uk](http://www.sargentltd.co.uk)



**4 Technical Data & Approvals**

**4.2 Motorhome Equipment -  
EC460,465,468,469,470 PSU & EC461,462,466,467 Control Panel**

Outline Specification		
INPUT 230v	230 Volts / 0 to 16 Amps	+ / - 10%
OUTPUT 230v	RCD protected, 3 x MCB outputs of 10A  Separate switched channels for water heater, space heater and charger  EC470 2 x 10A MCB Outputs & 1 x 16A MCB Output	
INPUT 12v	2 x 20A battery inputs via 2 x 4 way connectors	
SOLAR INPUT	1 x Dedicated solar panel input (20 to 100W panel) via a 2 way connector	
OUTPUT 12v	25A total output via multiple switched channels protected by 14 fused outputs	
CHARGER	Input 220-240 Volts AC +/- 10%, Frequency 50 Hz +/- 6%, Current 3A max.  DC Output 13.6 to 14.4 Volts nominal, Current 25 Amps max (300 Watts).  Overall size (HxWxD) 50 x 250 x 135mm	Fixing centres 128*128mm 1.2kg
Signal INPUT	4 x Fresh water level, 4 x Waste water level, 1 x Engine running, plus multiple vehicle connections	Fresh water negative sensed Waste water negative sensed
Data IN / OUT	CANBUS Data communication and power to Control Panel via 6 way connector	
IP rating	IP31	
Operating temperature	Ambient 0 to 35°C PSU case temperature with full load 65°C Max	Automatic shutdown and restart if overheated / overloaded

Dimensions		
EC468, EC469 PSU	Overall size (HxWxD) 315 x 195 x 150mm  Clearances 75mm above, 50mm left & right	Weight 2.9 Kg
EC462, EC467 Control Panel	Overall size (HxWxD) 87 x 250 x 15mm  Cut-out size (HxW) 70 x 233mm	Fixing centres 130*75mm  Weight 114 g

**4.3 Approvals**

System: BSEN 1648-1, BSEN1648-2 compliant, BS7671: 2008 compliant

Residual Current Device: RCD 40A 30mA trip to BS EN 61008

Miniature Circuit Breakers: MCB's type C 6000A breaking capacity to BSEN 60898

Electro Magnetic Compatibility (EMC) directive 2004/108/EC Certificate CE20071224-1

Integrated Charger: BS EN 60335-1/2.29, 2006/95EC, IEC61000-3.2/3:1995, 1.

Low Voltage Directive: 2006/95EC TUV-014900-A1, EN55022, Class B, EN55024/Level 2

## MOTORHOME BATTERY

**WARNING:** Use precaution when removing or replacing the battery, as batteries contain acid liquids which can cause severe injuries and damage when handled incorrectly. Refer to the cleaning and maintenance section.

Your motorhome has been fitted with one or two leisure batteries depending on size of vehicle and expected electrical loads. The battery is housed in a special compartment designed to hold the battery securely and to contain any electrolyte (acid) spillage. An additional soft tray is used on some vehicles to contain any electrolyte spillage. The compartments are either under the floor or in a side opening Thetford battery box opening to the outside of the vehicle. Under floor compartments are either sealed from the habitation compartment or a breather pipe is fitted to ensure any build up of explosive gases (hydrogen) is vented to the outside. If a breather pipe is fitted it is important to ensure that replacement batteries are also fitted with a breather pipe.

The battery or batteries should only be positioned in the appropriate compartment, which is vented to the outside, and be properly secured before travelling.

It is recommended that a good quality leisure battery is always connected when the motorhome electrical system is in use.

Leisure batteries are a deep cycling rechargeable heavy duty 12v battery designed to provide power for lights and other electrical appliances. Replacement batteries should be a proprietary brand leisure battery with a minimum 85amp - 110 amp capacity.

Note: Replacement batteries should be checked dimensionally before purchasing, to ensure fitment within the battery compartment, as brands vary in size.

It should be remembered that batteries suitable for the electrical demands of a motorhome differ in design from those for use with a car, and whilst the system may operate with a car battery it is strongly recommended that only a rechargeable leisure type battery,

maintained in good condition is used. The battery should be kept topped up at all times.

If two leisure batteries are fitted additional care is needed, as one battery deteriorates this can reduce the lifespan of the other.

**WARNING:** When connecting the battery, ensure that the correct polarity is observed (black is negative and red/brown is positive) and that the terminals are securely fastened.

Under normal circumstances it should not be necessary to remove the battery other than for routine inspection of terminals and 'topping up'.

**WARNING:** Explosive gases may be present at the battery. Take care to prevent flames and sparks in the vicinity.

Your motorhome has been fitted with an in-line 20 amp fuse between the battery terminal and the power supply unit. Do not use a higher rated fuse as this may cause damage to your motorhome.

**WARNING:** Switch off all appliances and lamps before connecting or disconnecting the battery.

Smoking is prohibited around the battery compartment.

To preserve the life of your leisure battery and charger please observe the following:

- i) Do not leave all 12v lights powered at the same time as this will drain your leisure battery more rapidly.
- ii) If all 12v lights must be powered together, ensure the battery is 'in-circuit' and that the battery charger is turned on.
- iii) For optimum performance use the transformer/charger unit with a leisure battery attached.

Please note the auxiliary battery or batteries supplied with your motorhome may not be fully charged and should be charged for a minimum of 24 hours before use.

Battery performance may be affected by a number of things such as ambient temperature, age, state of charge etc.

## Cleaning and maintenance

- Use protective clothing and glasses when handling a leaking battery, and avoid direct contact to the skin, eyes and respiratory organ.
- Should a battery leakage occur, please act according to the instructions supplied by the manufacturer of the battery. Act with caution as caustic substances are present in the battery.
- Always remove the battery and the power cable before carrying out any maintenance of the product.
- Before removing the clamps switch off all appliances.
- Use a soft cloth or sponge and a non-acid/abrasive detergent when cleaning the Battery Box and Soft Tray.
- To check if any acid is present in the Soft Tray, simply press it softly. A strong smell from the Soft Tray may also indicate spilled acid. The battery can be filled again with acid collected from the Soft Tray. Always treat spilled battery acid as hazardous waste. Dispose of spilled battery acid according to the local and national regulations.
- At the beginning of each season or extensive travelling, check the Soft Tray for faults and replace if necessary.
- The cleaning of the Battery Box and Soft Tray should only be done after all power sources have been switched off, in order to prevent a hazardous situations.

## THETFORD BATTERY BOX

The Battery Box has a CE socket for connect to a 230 V power supply and has a maximum load of 16amps.

- The Thetford Battery Box is designed for use with foot mounted batteries. These are recognisable by the rim around the bottom edge of the battery. This rim will locate against the back wall of the Battery Box and the angle metal bracket, which is screwed into place when the battery is fitted. The depth of the battery including rim should be between 173mm and 175mm.
- The maximum battery size that can be fitted is 225mm high (including terminals) x 175mm x 353mm wide. The depth and width dimensions include the rim around the bottom used for securing the battery.

**NOTE:** Batteries that are not foot mounted, ie. without a rim can still be fitted, but check first that they will fit within the battery box and can be secured before purchasing.

Before placing the battery inside the Battery Box, the battery should be placed into the Soft Tray and rested on the ground adjacent to the Battery Box. Carefully connect the electrical wires (the red cable attaches to the + pole and the black cable to the - pole of the battery).

Note! Incorrect connection of the cables will cause a short circuit with potential hazardous consequences.

After mounting the terminals, lift the battery together with the Soft Tray into the middle of the Battery Box compartment. Push the Soft Tray with battery to the back of the Battery Box, into the safeguard bulge.

## SOLAR PANEL CONNECTION

If necessary shift the Soft Tray to the right or left until the battery is in place in the safety area (see photo 1).

The battery is located in the compartment by the manual clamping plate. This has to be screwed to the front of the box.

Please ensure that the Soft Tray is pulled up tightly (to remove creases) before the plate is tightened. The rounded edge of the clamp prevents damage to the Soft Tray. Do not apply extreme force to the screw.

When attaching the 220/230 volts cable on the CE socket, the maximum recommended thickness of the cable is 10 mm. When closing the door, the attached cable is to be fed through the slot at the bottom right of the door.



### SOLAR PANEL CONNECTION POINT

A connection point has been included in the motorhome harness to take a 12v supply from an aftermarket solar panel (or similar device), to the leisure battery.

The solar panel must provide a fused and regulated output in order to connect to this point.

Solar panel installations should be undertaken by trained technicians who are familiar with the systems involved. Particular care should be taken when making connections to solar panels, which can generate high voltages ahead of a regulator when exposed to light.

Depending upon the specification of the motorhome, the connection point will be presented in one of the following formats:

#### Solar panel connection point with EC400 series control panel and related power supply unit

In these installations two way connectors will be present close to the leisure battery, and/or at a high level within the furniture (i.e. within a wardrobe, either visible or behind a removable cover).

From these connectors the supply is taken to the power supply unit, and is then directed to the leisure battery and/or vehicle battery. For further details of selecting which battery receives the solar charge, please see the EC400 series instructions.

#### Solar panel connection point -with EC400 series control panel and related power supply unit, and with roof mounted solar panel connection point

On some models, in addition to the connections detailed above which take a regulators output to the power supply unit, an additional harness and external connection box has been fitted. The intention of this link harness is to provide an electrical route between the inside of the motorhome body, and a solar panel installation on the roof of the motorhome.

## ACCESSORY HARNESSING

### Tow Bar Connection

The addition of tow bar electrics requires an electronic interface, to prevent problems with road lighting on the base vehicle. At the rear of the motorhome, a power supply is included in the motorhome harness for use with a tow bar interface. Please ask your dealer about the tow bar and tow bar harness kit that is available for use with this connection.

### GENERATOR USAGE

Caution should be used before connecting a generator to your motorhome.

**WARNING:** Never start or stop the generator while electrical loads are connected and switched on. Start the engine, let it stabilise, then connect the electrical load. To stop engine, disconnect the electrical load and let engine stabilise before switching off.

Whilst some generators use inverter technology, others use a more basic principle to generate the 230v supply. Preference should be to choose a generator which produces a consistent sinusoidal wave form with accurate voltage control.

The reverse polarity warning light may illuminate when using a generator. This is a normal side effect when using some types of generator. Instead of connecting the neutral and live conductors 110v above earth. This 110v difference causes the neon polarity indicator to illuminate.

In most cases it is safe to use a generator, but please consult the generator handbook for further information.

The connection box will be located towards the front of the motorhome roof and within this connection box is a two way weatherproof connector, to which a solar panel or panels can be connected directly.

Within a high level furniture locker, relatively close to the external connection box, two connectors will be found. The first is the other end of the link harness from the roof mounted connection box, this should be connected to the input connections of a solar panel regulator, and the second connector should be connected to the output from the regulator. A Brown and Blue pair of wires will feature in the link from the roof providing the input, with a Red and Black pair of wires taking the regulator output to the power supply unit.

### ACCESSORY HARNESSING

#### Alarm Power Supply

A connection exists within the motorhome harness, which can be used as a power supply for an alarm or tracking system. For security reasons, information regarding this is not published; please contact your dealer for further information.

#### Satellite Power Supply

Dependant on specification, in many motorhomes a power supply harness is included for use with roof mounted satellite systems. This power supply is terminated in a 4-way connector marked 'SATELLITE', and carries 12v positive, 12v negative, and a signal which can be used to detect when the vehicle engine is running. (The engine run signal is required by some systems to automatically retract satellite dishes.

In addition, on Kon-Tiki and E700 models which have a decoder / receiver position. At this position an additional 230v socket is present for use with a decoder / receiver, and a 12v supply is present (2-way connector, 12v positive and 12v negative), which can be used with an inverter (not supplied) to power a decoder/receiver when a mains supply is not available.

## HABITATION RELAY

Habitation relays are fitted to motorhomes by manufacturers to comply with the following legislation:

1. The Road Vehicles (Construction and Use) Regulations 1986 Regulation 60 - Radio interference suppression
2. Council Directive 72/245/EEC of June 20, 1972 amending for the purpose of their adaptation to technical progress, relating to the radio interference (electromagnetic compatibility) of vehicles and Council Directive 70/156/EEC on the approximation of the laws of the Member States relating to the type-approval of motor vehicles and their trailers.

A habitation relay must be fitted by manufacturers, safe guarding the consumer, the purpose of the relay is to disable non-homologated appliances/components whilst the vehicle is in transit.

Unintentional electromagnetic energy can be created by non-homologated devices within the habitation compartment, which could cause a malfunction of the base vehicles electronic systems/components, including safety critical items such as air bags, ABS braking etc.

In your motorhome the habitation relay is within the EC400 / 450 power supply unit.

The Swift Group recommends that electrical fault finding is undertaken by a trained Technician familiar with the systems involved. The basic checks below are therefore limited to items that can be checked without the use of tools etc. If in any doubt please consult a Swift dealer.

<b>Power Supply</b>	
<b>Fault</b>	<b>Remedy</b>
No 230v output from PSU	See Sargent EC400/EC450 information
No 12v output from PSU	See Sargent EC400/EC450 information
Reverse Polarity light illuminated	See Sargent EC400/EC450 information
Control Panel Problems	See Sargent EC400/EC450 information

<b>Appliance Not Operating</b>	
<b>Fault</b>	<b>Remedy</b>
Error code or fault light displayed on appliance (eg fridge LCD display)	Check appliance specific information for next steps
No display at appliance controls	Check power supplies are available (electric hook up, charger operating, battery in good state of charge). Majority of appliances will not be operational when engine is running.  Ensure control panel is ON.  Check appropriate fusing in Power Supply unit

<b>Internal Lighting</b>	
<b>Fault</b>	<b>Remedy</b>
Lighting not operational	Check power supplies are available Check control panel is ON, and that CABIN LIGHTS button has been pressed  Locate furniture mounted switches, where appropriate Check fuses on Power Supply Unit  Determine if light is LED or Tungsten / Halogen bulb, or Fluorescent tube – check and replace bulb if appropriate

## ELECTRICS FAULT FINDING

<b>Road Lighting</b>	
<b>Fault</b>	<b>Remedy</b>
Dashboard warning light illuminated / groups of road lights inoperative	<p>Check all bulbs are located correctly in bulb holders (especially those recently replaced). See bulb replacement information in Service Book</p> <p>If Tow Bar fitted check trailer lighting / disconnect trailer to determine if this is the cause of the fault.</p> <p>Check fuses in Fiat dash for main road lighting (see Fiat handbook for details of which light groups are fused)</p> <p>Check fuse in Power Supply Unit for auxiliary marker lights (Amber side markers, Luton / upper rear markers)</p>

<b>Electric Step Operation (When fitted)</b>	
<b>Fault</b>	<b>Remedy</b>
Step will not automatically retract with engine start	<p>Check fuses in Power Supply Unit.</p> <p>Check mechanical condition of step – clean / lubricate if appropriate.</p> <p>Check other functions that are linked to the running of the vehicle engine (i.e. fridge 12v operation). If these are also inoperative contact dealer.</p>
Step does not respond to furniture switch	<p>Check fuses in power supply unit</p> <p>Check mechanical condition of step – clean / lubricate if appropriate.</p> <p>It is possible to link the operation of the step to the lock/unlock commands from the central locking keyfob. If this feature is enabled on your motorhome, check if operation of the step via the central locking keyfob is possible. To enable / disable the keyfob feature contact your dealer.</p>

<b>Power Supply</b>	
<b>Fault</b>	<b>Remedy</b>
Fresh water level sensor gives incorrect readings	<p>Use floor hatch within motorhome to access top of water tank, remove sensor (4-screws) and clean probes</p> <p>If problems persist, dealer assistance required for further fault finding.</p>
Waste water level sensor gives incorrect	<p>If possible, from below motorhome remove level sensor from top of waste tank, and clean probes. Alternatively, clean waste tank internal surfaces by flushing through with water or cleaning agent.</p> <p>If problems persist, dealer assistance required for further fault finding.</p>

<b>Battery Discharge</b>	
<b>Fault</b>	<b>Remedy</b>
Leisure battery discharging earlier than anticipated	<p>If appropriate to battery, check condition and top-up battery fluid if required</p> <p>Have condition of leisure battery checked by dealer or tyre/exhaust/battery specialist</p> <p>If motorhome is not in use, ensure 'SYSTEM SHUTDOWN' button on Power Supply Unit is being used to isolate all circuits</p> <p>If motorhome is in use, see consumption table in handbook – are several items operating simultaneously / is total load likely to cause discharge.</p> <p>Check charger is operational when mains hook up is present, and that the charger is allowed sufficient time to replenish battery / batteries.</p>
Vehicle battery discharging earlier than anticipated	<p>If appropriate to battery, check condition and top-up battery fluid if required</p> <p>Have condition of leisure battery checked by dealer or tyre/exhaust/battery specialist</p> <p>If motorhome is not in use, see base vehicle handbook section headed 'periods of inactivity'. Consider use of vehicle battery isolator</p> <p>If motorhome is in use, Power Supply Unit configured to charge / maintain both leisure and vehicle batteries. (Contact dealer for further assistance if unsure)</p>

## ELECTRICS FAULT FINDING

<b>Audiovisual Equipment</b>	
<b>Fault</b>	<b>Remedy</b>
Radio switches off intermittently	Radio will not remain on indefinitely when vehicle ignition is switched off. See base vehicle instructions for further detail.
Rear view camera system inoperative when reversing (if fitted)	Check if camera system can be switched on manually, using power button on rear view mirror Check Reverse Lights are operational on rear of motorhome. (Check base vehicle fuses if reverse lights are inoperative)
Rear view camera system inoperative whether moving forward or reversing (if fitted)	Check fuses in habitation area fusebox (Power Supply Unit)

Truma Ultrastore water heater operating instructions .....	90
Truma S 3002 auto space heater .....	94
Teb fan .....	96
Truma Ultraheat additional electric heating .....	97
Truma Combi 4 / Combi 6 .....	99
ALDE Compact 3010 Quick Start Guide.....	108
ALDE Compact 3010 Control Panel - Functions and Symbols .....	113
Thetford absorption refrigerators .....	124
Dometic Waeco CB-40 Cool box .....	136
Cooker 3 burner and hotplate .....	137
Microwave oven .....	143
Extractor hood 524 .....	145
Thetford C250CS & C250S cassette toilet .....	146
TV inlet .....	150
Windows .....	152
Softrollo Blinds (Seitz) .....	152
Windows / Roller Blind Advice .....	153
Roof lights .....	154
Mini Heki rooflight .....	154
Skyview operating instructions .....	155
Blind and Flyscreen .....	156
Care of laminate tops, tables, furniture and doors .....	156
Doors .....	157
Seat Swivel (Driver / Passenger) .....	157
Side Lockers .....	157
Bunk and luton bed safety .....	157
Tables .....	157
Table storage .....	158
12V reading lamp .....	158
Trigger shower heads .....	158
Omnistep single step .....	158
Fiama F45S/TiL side awning .....	159
Colour reference.....	160
Drop down TV mechanism .....	160
Cycle racks.....	161
Reverse camera system .....	161

# TRUMA ULTRASTORE

## Equipment Specification

For details on type of equipment fitted in your motorhome, please refer to the Sales Brochure or Dealer.

### IMPORTANT

To maximise the use and life of all fitted equipment in your motorhome it is essential that any accompanying manufacturers' literature is read fully. All recommended maintenance and preparation procedures should be followed. The information provided in this handbook is only intended as a guide. If in any doubt consult your manufacturer appointed dealer, particularly before attempting to install EXTRA EQUIPMENT.

**Notice:** In the interest of safety, replacement parts for an appliance shall conform to the appliance manufacturer's specifications and should be fitted by them or their authorised agent.

## TRUMA ULTRASTORE WATER HEATER OPERATING INSTRUCTIONS

**Attention:** Before using for the first time, it is essential to flush the entire water supply through with clean warm water. Always mount the cowl cover when the water heater is not being operated! Drain the water heater if there is a risk of frost!

There shall be no claims under guarantee for damage caused by frost!

When connecting to a central water supply (rural or city connection) or when using more powerful pumps, a pressure reducer must be used which prevents pressures of greater than 2.8 bar occurring in the Ultrastore.

## Filling the Truma Ultrastore with water

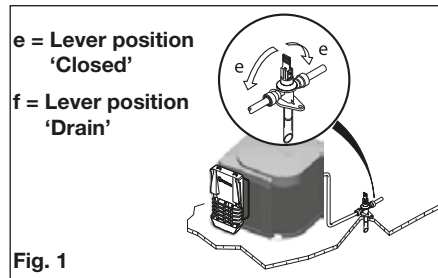

1. Check that the drain valve in the cold-water intake is closed. Lever should be in the horizontal position (e).
2. Open the hot tap in the bathroom or kitchen with pre-selecting mixing taps or single lever fittings set to hot.
3. Switch on power for water pump (main switch or pump switch). Leave the tap open to let air escape while the water heater is filling. The heater is filled when water flows out of the tap.

**Note:** residues of frozen water can prevent filling if there is a frost. The water heater can be defrosted by switching on the heater for a short period (max 2 mins). Frozen pipes can be defrosted by heating the room.

**Note:** If just the cold water system is being used, without water heater, the heater tank is also filled up with water. Therefore, order to avoid damage through frost, the water contents must be drained by opening the drain valve when the system is no longer in use.

### Draining the water heater

1. Disconnect power for water pump (main switch or pump switch).
2. Open hot water taps in bathroom and kitchen.
3. Open safety/drain valve: Lever in vertical position, (Fig. 1) position (f).
4. The water heater is now drained directly to the outside via the safety/drain valve. Check that the water contents have been completely drained (10 litres).

## Gas operating instructions

**Attention:** Never operate the water heater without water in it!

1. Remove cowl cover.

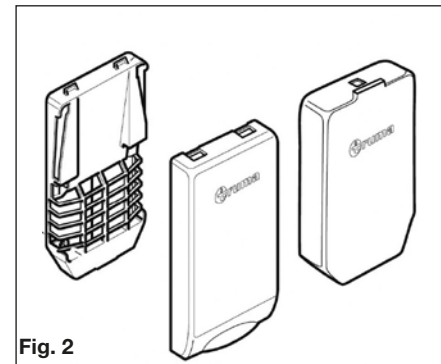

2. Open gas cylinder and open the gas shut off valve at the manifold.
3. Turn on the heater by moving the central rocker switch to the 50°C or 70°C position as desired. (Fig 3).

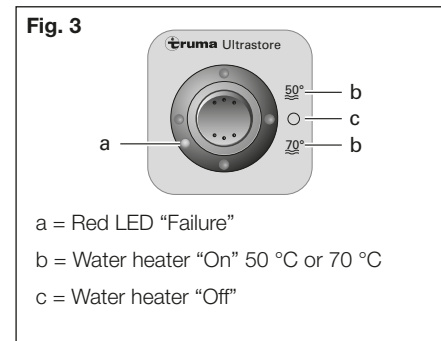

4. After 5 seconds clicking sound will be heard from water heater, as boiler attempts to light  
Outer collar ( a ) in control module will turn Red if boiler fails to light - If boiler does fail to light, turn switch back to central position ( c ), wait 5 minutes, and then repeat step 3.

5. If there is air in the gas supply line, it may take up to a minute before the gas is available for combustion. If the appliance switches to "Failure" during this period, switch off the appliance - wait 5 minutes - and switch on again!

### Switching off (gas operation)

Switch off the water heater by moving the rocker switch to the central position. (Fig 3).

**Drain the water heater if there is a risk of frost!**

If the water heater is not to be used for a longer period, mount cowl cover and close the heater gas shut off valve at the manifold.

**There shall be no claim under guarantee if this point is not observed.**

**Always remove the cowl cover prior to operating the water heater!**

### Red indicator lamp "Failure"

The red indicator lamp (d) lights up if there is a failure.

The reason for such an indication is, for example, no gas available or air in the gas supply system, triggering of the excess temperature monitor etc. To unlock, switch off the appliance, wait 5 minutes, and switch on again.

**In event of faults, always contact the Truma Service on Tel: 01283 586020.**

### Electrical Operating Instructions

1. Ensure that the heater tank is full of water before operating the unit on electric power.
2. Turn on the electric heating element by operating the water heater switch on the power supply unit. See page 66
3. At the Ultrastore control (Fig 4.), move the rocker switch from the central off position (h), to either 850W or 1300W (g). The 850W



setting will take longer to heat the water, but less power than the 1300W setting.

4. Once a setting has been selected, the electric element within the water heater will turn ON and OFF automatically, to aim to regulate the water temperature at 70°C. As long as there is a suitable mains supply present, and the water system is primed, there is no requirement to switch the water heater 230V element off.

Fig. 4

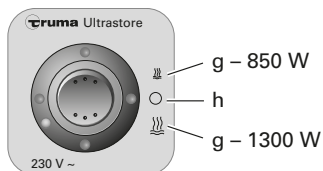

g = Water heater 'on' 850W or 1300W  
h = Water heater "Off"

**Note:** The water temperature cannot be selected, automatic temperature limitation at approx. 70°C. For a faster heating up period the appliance can be simultaneously operated with gas and electrical power.

The electrical heating rod is fitted with an excess temperature cut-out. In the event of a fault, switch off at the operating element. Check water content, refill if required (close drain valve). Wait 10 minutes, then switch on again.

**Maintenance**

We recommend the Truma system care set for cleaning, disinfecting and looking after the boiler. Other products – in particular products containing chlorine – are unsuitable.

To avoid infestation by micro-organisms, the water content must be heated to 70 °C at regular intervals. Clean the device and the ventilation slits with a dry and fluff free cloth.

**Fuses**

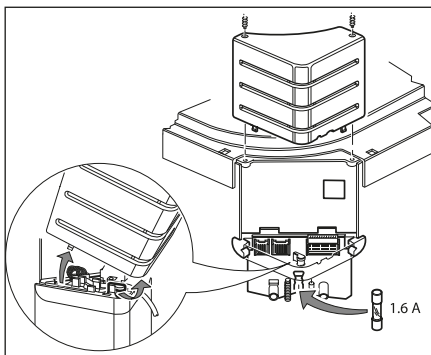

The water heater 12 V fuse is on the electronic control unit on the water heater.

**Note:** Only replace the miniature Fuse on the p.c.b. with a fuse of the same type: 1.6 A, EN 60127-2-3 (slow action). If there is a defect in the electronics, return the control p.c.b. well padded. If you fail to pack it correctly the guarantee shall no longer be valid. Only use original Truma Ultrastore control p.c.b.'s as spare parts!

SYMPTOM	CAUSE	RECTIFICATION
<p><b>Gas operation</b></p> <p>When switching on, the heater does not operate.</p> <p>When switching on, the heater does not operate and the red lamp lights up after approx. 30 secs.</p> <p>Heater operates for a prolonged time and then the red lamp lights up.</p>	<ul style="list-style-type: none"> <li>No 12 V supply voltage.</li> <li>Window open.</li> <li>Cowl cover fitted.</li> <li>No gas supply.</li> <li>Incorrect gas pressure.</li> <li>Air in the gas supply.</li> <li>Over temperature thermostat operated.</li> </ul>	<ul style="list-style-type: none"> <li>Check the power supply (operation voltage min. 10.5 V).</li> <li>Check the water heater fuse (refer to maintenance "Fuses").</li> <li>Close any windows above the cowl.</li> <li>Remove cowl cover and / or clear any obstruction.</li> <li>Check gas valves and gas bottle.</li> <li>Check gas valves and gas bottle.</li> <li>To unlock (and purge air), switch off the appliance, wait 5 minutes, and switch on again.</li> <li>Check water content, refill if required (close drain valve).</li> <li>To unlock, switch off the appliance, wait 5 minutes, and switch on again.</li> </ul>
<p><b>Electrical operation</b></p> <p>When switching on, the heater does not operate.</p>	<ul style="list-style-type: none"> <li>No 230 V supply voltage.</li> <li>Over temperature thermostat operated.</li> <li>Too slow warm-up in position 850 W</li> </ul>	<ul style="list-style-type: none"> <li>Connect the motorhome to the site supply and / or check residual current circuit breaker.</li> <li>Check water content, refill if required (close drain valve).</li> <li>The electrical heating element is fitted with an excess temperature cut-out. In event of a fault, switch off at the control panel, wait 10 minutes, then switch on again.</li> <li>Please contact the Truma Service.</li> </ul>
<p><b>Water supply</b></p> <p>Water drips from the safety/ drain valve.</p> <p>When opening the cold water tap, hot water tap comes out.</p>	<ul style="list-style-type: none"> <li>Water pressure too high.</li> <li>Hot water flows back through the cold water supply.</li> </ul>	<ul style="list-style-type: none"> <li>Check water pressure (max. 2.8 bar), use a pressure reducer when connected to central water supply.</li> <li>Fit a no-return valve in the cold water supply (refer to installation instructions "Water connection").</li> </ul>

**If fault persists please contact the nearest Truma Service (see Truma Service Booklet or www.truma.com).**

## TRUMA S 3002 SPACE HEATER

### TRUMA S 3002 SPACE HEATER

Models with Manual Piezo Ignition: Lighting Instructions

1. Turn on gas cylinder and open the shut off valve at the manifold.
2. Turn control knob (a) to thermostat setting 1 - 10 and press it down as far as the stop. At the same time keep operating the piezo ignitor rapidly until the flame ignites.

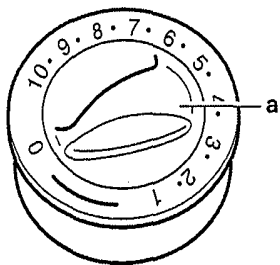

3. Keep the control knob pressed down for a further 10 seconds to allow the safety pilot to operate.
4. Observe through the inspection window for a further 10 seconds so as to check that the flame has not been extinguished due to air in the line (caused by a change of gas cylinder).

**Warning:** Wait for 2 minutes before re-igniting, otherwise risk of misfiring! This also applies if a working heater goes out and has to be re-lit.

If air has got into the gas line, it may take up to two minutes before gas is available for combustion. During this period, the operating handle should be kept pressed down and the pressure igniter constantly actuated until the flame appears.

### Models with Automatic Ignition: Lighting Instructions

Before using the heater for the first time, ensure that a battery has been inserted (see "Changing the battery on page 96").

1. Turn on gas cylinder and open the shut off valve at the manifold.
2. Turn control knob (a) to thermostat setting 1 - 10 and press it down as far as the stop. Ignition takes place automatically (ignition sparking audible) until the flame ignites. Keep the control knob pressed down for a further 10 seconds to allow the safety pilot to operate.

**Warning:** In the event of a fault: always wait 2 minutes before attempting to reignite!

If the flame goes out again, re-ignition occurs immediately during the closing time of the safety pilot (approx. 30 seconds).

If there is no flame, the automatic ignitor continues to operate until the control knob (a) is switched to "0".

If there is air in the gas supply line, it can take up to two minutes until there is gas available for combustion. During this time hold the control knob down until the flame lights.

### Thermostat

Set the required room temperature at the control knob (numbers 1-10). For an average room temperature of approx. 22°C we recommend setting:

3-5 Without the Trumavent Fan (switched on)

4-8 With the Trumavent Fan

### Switching Off

Set control knob to "0". If turning off for a long period of time, close the shut off valve at the manifold. Close valve of gas cylinder.

### Important Operating Notes

1. If the gas supply line is filled with air, it may take up to a minute before the gas becomes available for combustion. During this time depress the control knob and continuously operate the Piezo ignitor until the flame ignites.
2. You will have to find out the exact thermostat setting yourself, depending on how much heat you need.
3. Repairs are only to be carried out by a competent service engineer.

**Attention:** A new O-ring must always be installed after dismantling the exhaust duct.

4. Any alteration to the appliance (including exhaust duct and cowl) or the use of spare parts and accessories, which are important to the function of the heater and which are not original Truma parts, as well as the non-observance of the installation and operating instructions, will lead to the cancelling of the guarantee and exclusion of liability claim.

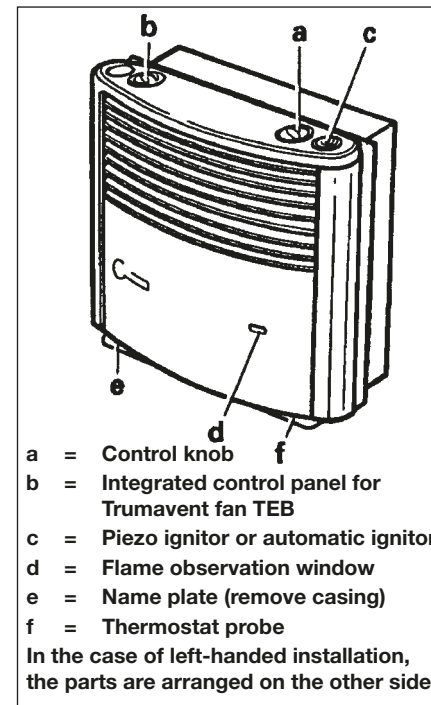

- a = Control knob
- b = Integrated control panel for Trumavent fan TEB
- c = Piezo ignitor or automatic ignitor
- d = Flame observation window
- e = Name plate (remove casing)
- f = Thermostat probe

**In the case of left-handed installation, the parts are arranged on the other side.**

5. During the initial operation of a brand new appliance, a certain amount of fumes and a slight smell may be noticed for a short while. Remedial action is to immediately run the heater at maximum output and to ensure adequate room ventilation.
6. In winter, before switching on the heater, remove all snow from the cowl.
7. Inspect the exhaust duct and all connections at regular intervals and always whenever there is a blow back (misfire). It is essential that the exhaust duct is installed so that it slopes upwards over its whole length and is securely fixed with several clamps. Never place any object on the exhaust duct, since this could result in damage. The exhaust duct connection to both the heater and the cowl must be firm and well sealed.
8. Never allow the warm air outlet on the heater to be obstructed in any way. For instance never hang washing on or in front of the heater to dry. Misusing your heater in this way could cause serious damage from overheating. Do not place flammable objects near the heater. Please follow these guidelines in the interest of your own safety.
9. If the burner makes an unusual noise or if the flame lifts off while burning, it is likely that the regulator is faulty and it is essential to have it checked.
10. Cleaning (with switched off appliance): It is recommended that at least once a year, before the heating season starts, you remove any dust that has collected on the heat exchanger base plate.

Do not operate heaters with incorrectly fitted or damaged exhaust ducts.

**Changing of batteries**

Changing the Batteries on the Automatic Ignitor

Only change the batteries with the heater switched off.

Always insert new batteries at the beginning of the heating season.



Remove front of heater retaining screw, located through centre of black grill. Unclip front of heater, slide up battery cover to reveal battery. Change the batteries. Observe plus/minus.

Only use temperature resistant (+70°C), leak-proof Mignon round cells (LR 6, AA, AM 3, Art. no. 30010-23600). Other batteries could lead to malfunctions!

**WARNING:** Do not cover or obstruct the front of the fire as this can ignite and/or divert heat downwards onto the floor coverings and cause permanent damage or fire.

**TEB FAN**

**Always observe the operating instructions prior to starting!**

**The vehicle owner is responsible for the correct operation of the appliance.**

**Repairs are only to be carried out by a qualified person**

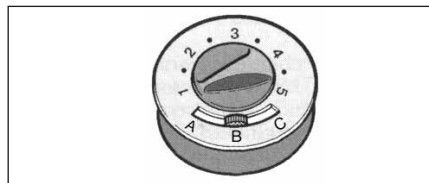

- a = Manual control**  
(e.g. for ventilation) Adjust desired output at the control knob.
- b = Off**  
(or automatic operation/ heating with heaters Trumatic S 3002 K and S 5002 K)
- c = Automatic operation**  
(Heating) The output steadily adjusts to the respective heat emission of the heater. The maximum output can be limited at the control knob, as required. The regulating between this value and slow running is carried out automatically.

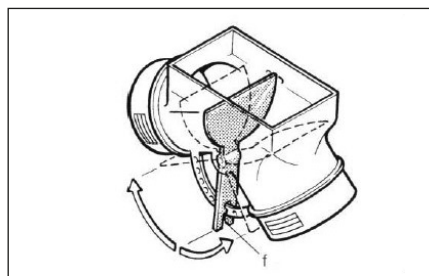

The quantity of air can be individually adjusted at the air flap (f), for warm air distribution. In centre position 50% of the warm air is distributed to each outlet.

If the air output drops or the operating noise increases, the fan impeller wheel may be severely soiled.

**Note:** The motorhome control panel, situated above the entrance door must be switched on for the fan to operate. See page 66

**Cleaning**

(With switched off appliance!) We recommend removing dust which has collected on the heat exchanger and base plate of the heater and on the impeller wheel of the Trumavent fan, once a year before the heating season starts. Clean the impeller wheel carefully using a brush or tooth brush.

**TRUMA ULTRAHEAT ADDITIONAL ELECTRIC HEATING**

**For Trumatic S 3002 heaters**

**Function description**

Truma-Ultraheat is an additional 230V electric heater to the LPG heater models Trumatic S 3002/S 5002.

It is possible to operate the heater on gas only, electricity only or simultaneously with electricity and gas.

When operating simultaneously on electric and gas the electric unit will switch on and off to prevent over heating.

When operating on electric only we recommend that the fan control is set at position 3 on manual or automatic operation.

The electric heater can also be operated without the Trumavent fans.

**WARNING:** Surfaces become hot in use, guards provided do not give full protection to the young or elderly.

**Operating instructions**

Before operating the heater for the first time it is essential to observe the operating instructions, enclosed with the heater.

**Control panel with thermostat**

- a** = Rotary switch "Off"
- b** = Rotary switch "On"  
power settings:  
500 - 1000 - 2000 W
- c** = Rotary control knob for room temperature (illuminated by green indicator lamp "operation")

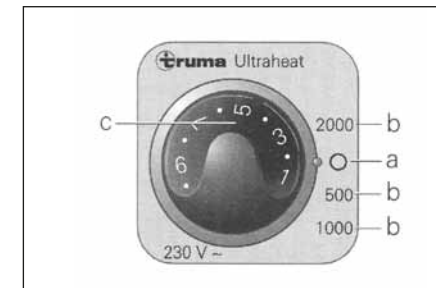

**Switching On**

Turn on the electric heating element by operating the space heater switch on the power supply unit. See page 66.

1. To switch on, turn the rotary switch to the desired output level (b).
2. Set rotary control knob (c) to the desired room temperature.

The thermostat setting on the operating element (1-9) must be determined individually depending on the heating requirement and the type of vehicle. For an average room temperature of about 23°C, we recommend a thermostat setting of about 6 - 8.

## BLOWN AIR HEATING

The electric heater can also be operated without the Trumavent fans.

If the heater is operated simultaneously with electricity and gas, the electrical unit will switch itself off before overheating occurs as a result of the stronger gas burner.

**Switching off**

Switch the heating system off at the rotary switch (a).

**Important operating notes**

- Repairs may only be carried out by a qualified LPG engineer.
- The heater's hot air outlet should under no circumstances be blocked. Never hang clothes or similar in front of or on top of the heater to dry. This could cause serious damage to the heater as a result of overheating. Do not place inflammable materials near the heater! Please observe these instructions for your own safety.
- The performance of the room thermostat will be affected if temporarily covered or obstructed
- When operating a brand-new heater for the first time (or after it has been idle for a lengthy period) you may temporarily notice a slight smoke and smell. We advise running the heater at full power and thoroughly ventilating the room.
- Any modifications to the appliance or the use of spare parts and accessories important for operation which are not original Truma parts, of non-observance of the instructions for installation and use will result in the guarantee becoming invalid and no liability will be assumed.

Furthermore the approval for operating the appliance will become invalid and in some countries also the approval for operating the vehicle.

**The mains element on the space heater is designed for supplementary heating. It is not recommended to run along side the gas for prolonged periods of time.**

**Technical Data**

Power supply:	230 V ~, 50 Hz
Power consumption at power setting:	500 W: 2.2 A 1000 W: 4.5 A 2000 W: 8.5 A
Weight:	approx 2kg

**Butterfly outlets**

The butterfly plate may be opened or closed to control the quantity of air and may also be twisted around to control direction.

For uniform distribution, outlets nearest the heater should be closed more than those further away.

**Blown air**

The air ducting outlets are generally of the butterfly type and may be opened or closed by adjusting the butterfly valves. Twisting the disc in its housing directs the flow in the direction required.

One outlet on each leg of the air ducting layout must be kept open at all times. Under no circumstances should the air ducting outlets be blocked.

**Cleaning**

(with switched off appliance!) We recommend removing dust which has collected on the heat exchanger and base plate of the heater and on the impeller wheel of the Trumavent fan, once a year before the heating season starts. Clean the impeller wheel carefully using a brush or tooth brush.

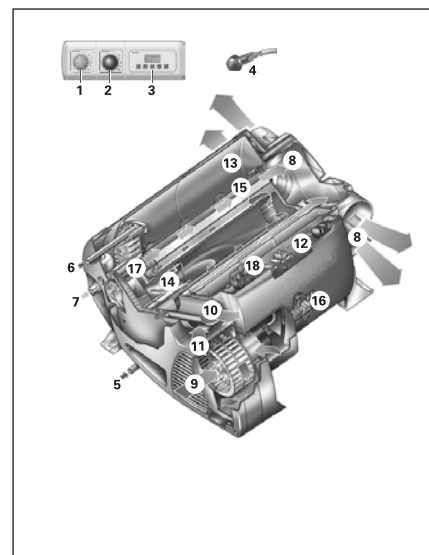
**Truma Combi 4 / Combi 6**

- Control panel
- Power selector switch
- Time switch ZUCB (Accessories)
- Room temperature sensor
- Cold water connection
- Hot water connection
- Gas connection
- Hot air outlets
- Recirculated air intake
- Waste gas discharge
- Combustion air infeed
- Electronic control unit

## TRUMA COMBI 4/COMBI 6

- Water container (10 litres)
- Burner
- Heat exchanger
- Power electronics
- Heating elements 230 V
- Overheating switch 230 V

**Function description**

The liquid gas heater Combi E is a warm-air heater with integrated hot water boiler (10 liter volume). The burner operates fan-supported, which ensures trouble-free function even when on the move. The unit also has heating elements for electrical operation.

In winter operation the heater can be used to heat the room and simultaneously warm water. If only warm water is required, select summer operation.

3 different options are available for operating the unit.

- gas operation only Propane / Butane for autonomous use
- electrical operation only 230 V for stationary use on camp sites
- or gas and electrical operation – mixed operation only possible in winter mode.

**Winter operation**

In winter operation, the unit automatically selects the required power setting according to the temperature difference between the temperature set on the control panel and the current room temperature. When the boiler is filled, the water is automatically heated as well. The water temperature depends on the selected operational mode and the heater output.

All 3 energy selection options can be used for winter deployment.

With gas operation the unit automatically selects the output level that is required.

## TRUMA COMBI 4/COMBI 6

Depending on the fuse protection at the camping site, power of 900 W (3.9 A) or 1800 W (7.8 A) can be manually selected for electrical operation.

If more output is required (e.g. heating up or low outside temperatures) gas or mixed operation should be selected so that enough heating power is always available.

With mixed operation, 230 V electrical operation is preferred if the power requirement is low (e.g. for maintaining the room temperature). The gas burner is not enabled until the power requirement is higher, and is the first to switch off during heat-up operations.

### Summer operation (boiler operation only)

Gas operation or 230 V electrical operation is used for hot water preparation. The water temperature can be set to 40 °C or 60 °C.

With gas operation the water is heated at the lowest burner setting. Once the water temperature is reached, the burner switches off.

Depending on the fuse protection at the camping site, power of 900 W (3.9 A) or 1800 W (7.8 A) can be manually selected for electrical operation.

Mixed operation is not possible. With this setting the unit automatically selects electrical operation. The gas burner is not enabled.

### Repairs may only be carried out by an expert

Guarantee claims, warranty claims and acceptance of liability will be ruled out in the event of the following:

- modifications to the unit (including accessories),
- modifications to the exhaust duct and the cowl,
- failure to use original Truma parts as replacement parts and accessories,
- failure to follow the installation and operating instructions.

It also becomes illegal to use the appliance, and in some countries this even makes it illegal to use the vehicle.

During the initial operation of a brand new appliance (or after it has not been used for some time), a slight amount of fumes and smell may be noticed for a short while. It is a good idea to heat the device up several times in summer operation (60 °C) and to make sure that the area is well ventilated.

Heat-sensitive objects such as spray cans or flammable liquids may not be stored in the same compartment where the heater is installed because, under certain conditions, this area may be subject to elevated temperatures.

### Important operating notes

The integrity and tight fit of the exhaust gas double duct must be checked regularly, particularly at the end of long trips. Also check the mounting of the appliance and the cowl.

Following a blow-back (misfire) always have the exhaust gas system checked by an expert!

Always keep the cowl for the exhaust duct and combustion air intake free of contamination (slush, ice, leaves etc.).

The hot air outlets and the recirculated air intake openings must be free so that the unit does not overheat. The integrated temperature limiter blocks the gas supply when the unit becomes too hot.

### Operating Instructions

Always observe the operating instructions and "Important operating notes" prior to starting! The vehicle owner is responsible for the correct operation of the appliance.

Before using for the first time, it is essential to flush the entire water supply system through with clean water. If the heater is not being used, always drain the water contents if there is a risk of frost. There shall be no claims under guarantee for damage caused by frost!

### Power selector switch

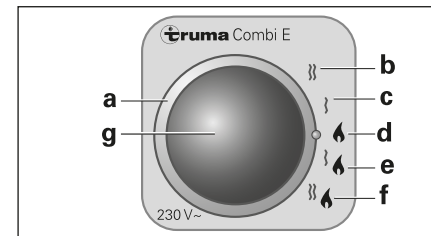

- a = Power selection rotary switch
  - b = Electric operation 230 V, 1800 W
  - c = Electric operation 230 V, 900 W
  - d = Gas operation
  - e = Mixed operation\* (900 W gas and electrical operation)
  - f = Mixed operation\* (1800 W gas and electrical operation)
  - g = Yellow LED on = "Electrical operation"
- \* Winter mode only!

In summer mode the unit automatically selects electric operation at the preselected electrical power of 900 W or 1800 W.

### Switching on the electric heating elements as well does not increase the maximum heating power.

### Control panel

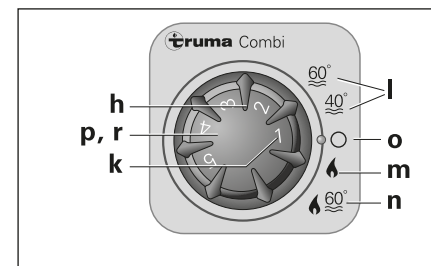

- h = Rotary switch for room temperature (1 – 5)
- k = green LED lit "Operation" green LED blinking "after-running" is active in order to reduce the unit's temperature
- l = Summer operation (water temperature 40 °C or 60 °C)

m = Winter operation (heating without water temperature monitoring or with drained water system)

n = Winter operation (heating with water temperature monitoring)

o = Rotary "Off" switch

p = yellow LED lit "Boiler heat-up phase"

r = red LED lit, red LED blinking "Failure"

### The LEDs are visible only when the unit is switched on.

**Note:** The motorhome control panel, situated above the entrance door must be switched on for the combi boiler to operate. See page 66

### Room thermostat

To measure the room temperature, the room temperature sensor (See page 99) is fitted to the furniture. The exact location is determined by the layout of the vehicle.

The thermostat setting on the control panel (1 – 5) must be determined individually depending on the heating requirement and the type of vehicle. For an average room temperature of about 23 °C, we recommend a thermostat setting of about 4.

### Taking into operation

Heating is possible without restrictions with gas, electrical and mixed operation, with or without water.

Check to make sure the cowl is unobstructed. Be sure to remove any covers that may be present.

For operating on gas turn on gas cylinder and open the shut off valve at the manifold.

For operating on electric operate the water heater switch on the power supply unit. See page 65

**Summer operation (boiler operation only)**

Select gas or electrical operation using the power selector switch. Illumination of the yellow LED (g) on the power selector switch indicates that the unit is operating with 230 V.

Mixed operation (gas and electrical) is not possible in summer mode. With this setting the unit automatically selects electrical operation with a preselected power setting of 900 W or 1800 W.

Move the rotary switch on the control panel to position (l – summer operation) 40 °C or 60 °C. The green (k) and yellow (p) LEDs light up.

When the selected water temperature is reached (40 °C or 60 °C) the heater shuts off and the yellow LED (p) goes off.

**Winter operation****• Heating with water temperature monitoring**

Select gas, electrical or mixed operation using the power switch. Illumination of the yellow LED (g) on the power selector switch indicates that the unit is operating with 230 V. Move rotary switch on control panel to operating position (n). Set the rotary switch (h) to the desired thermostat setting (1 – 5). The green LED (k) for operation is lit and simultaneously indicates the position of the selected room temperature. The yellow LED (p) indicates the water's heat-up phase.

The device automatically selects the required power setting in accordance with the temperature difference between the temperature selected on the control panel and the current room temperature. When the room temperature selected on the control panel is reached, the heater switches back to the smallest setting and heats the water to 60 °C. Once the water temperature is reached, the heater switches off and the yellow LED (p) goes out. The warm air fan can continue to run in order to cool the unit (after-run).

**• Heating without water temperature monitoring**

Select gas, electrical or mixed operation using the power switch. Illumination of the

yellow LED (g) on the power selector switch indicates that the unit is operating with 230 V. Move rotary switch on control panel to operating position (m). Turn the rotary switch (h) to the desired thermostat setting (1 – 5). The green LED (k) for operation is lit and simultaneously indicates the position of the selected room temperature. The yellow LED (p – water's heat-up phase) will be lit only when the water temperature is below 5°C! The device automatically selects the required power setting in accordance with the temperature difference between the temperature selected on the control panel and the current room temperature. Once the room temperature selected on the control panel has been reached, the heater switches off. The warm air fan continues to run at slow speed until the outgoing air temperature (on the unit) has fallen to 40°C or less.

If the boiler is filled, the water will automatically be heated at the same time. The water temperature is then dependent on the heating output being given off, and the duration of heating required to reach the desired room temperature.

**• Heating with drained water system**

Select gas or electrical operation using the power selector switch. Illumination of the yellow LED (g) on the power selector switch indicates that the unit is operating with 230 V. Move rotary switch on control panel to operating position (m). Turn the rotary switch (h) to the desired thermostat setting (1 – 5). The green LED (k) for operation is lit and simultaneously indicates the position of the selected room temperature. The yellow LED (p) will be lit only when the temperature of the unit is below 5°C!

Depending on the operating mode, the unit will automatically select the required power level according to the temperature difference between the setting on the control panel and the current room temperature. Once the room temperature selected on the control panel has been reached, the heater switches off. The warm air fan continues to run at slow speed until the outgoing air temperature (on the unit) has fallen to 40°C or less.

**Switching off**

Switch off heater at control panel using rotary switch (position o). The green LED (k) goes off.

If the green LED (k) blinks after switching off, then the unit's after-running is active in order to reduce the unit's temperature. This will end after a few minutes and the green LED (k) will go off.

Always drain water contents if there is a risk of frost! If the appliance is not to be used for a prolonged period, close the gas shut off valve at the manifold.

**Gas operation fault**

If a fault occurs during gas operation the red LED (r) on the control panel illuminates.

Please consult the Trouble-Shooting list for possible causes.

A reset (fault reset) is carried out by switching off, waiting until all LED's on the control panel have stopped flashing, and then switching the heater on again.

**Electrical operation fault**

If a fault occurs during electrical operation the yellow indicator lamp (g) on the power selector switch goes off.

Possible causes can be found in the troubleshooting list.

If the 230 V power supply is interrupted for just a brief period of approximately 1 second during operation, the heater will subsequently resume as normal.

**Filling the water heater**

Switch on power for water pump (main or pump switch).

Open hot water taps in kitchen and bathroom, (set preselecting mixing taps or single-lever fittings to "hot"). Leave the fittings open for as long as it takes for the boiler to displace the air and fill up, and the water to flow without interruption.

If just the cold water system is being operated, without using the water heater, the heater tank also fills up with water. To avoid frost damage, the boiler must be drained through the drain valve, even if the boiler was not operated.

When connecting to a central water supply (rural or city mains), a pressure reduction valve must always be installed to prevent pressures above 2.8 bar from developing in the water heater.

**Draining the water heater**

Switch off power to water pump (main or pump switch).

Open hot water taps in kitchen and bathroom.

In order to check the water that is flowing out, place an appropriate container (capacity 10 litres) beneath the drain valve.

Open the drain valve which is situated next to the boiler by lifting the yellow handle into the vertical position.

Check whether all of the water in the boiler (10 litres) has been drained into the container via the drain valve.

**There shall be no claims under guarantee for damage caused by frost!****Maintenance**

Only original Truma parts may be used for maintenance and repair work! Materials in the device which come into contact with water are suitable for use with drinking water (see manufacturer's declaration: [www.truma.com/downloads/manufacturers\\_declaration](http://www.truma.com/downloads/manufacturers_declaration)).

Bio-film, deposits and limescale must be removed using chemicals to protect the unit from infestation by microorganisms.

Only chloride-free products must be used in order to prevent damage to the unit.

The effectiveness of the use of chemicals to combat microorganisms in the unit can be increased by heating the water in the boiler to 70 °C at regular intervals.

Move power selector switch to gas operation (d) to do this.

Move the rotary switch on the control panel to position (l – summer operation) 60 °C. The green (k) and yellow (p) LEDs light up.

## TRUMA COMBI 4/COMBI 6

Once the water in the boiler has reached a temperature of 60 °C, the burner will switch off and the yellow LED (p) will go out. The unit must stay switched on for at least 30 minutes and no warm water may be removed. The residual heat in the heat exchanger will heat the water up to 70 °C.

**Fuses 12 V**

The fuse is in the electronics beneath the connection cover.

Replace the unit's fuse only with an identical fuse.

Device fuse: 10 A – slow – (T 10 A)

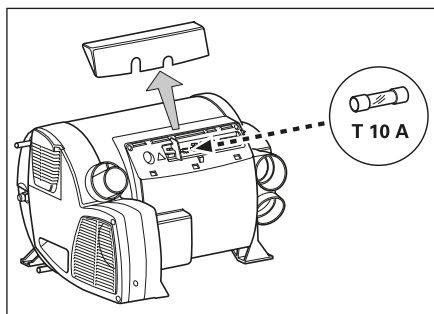
**Fuses 230 V**

The fuse and the power supply lines must only be replaced by an expert!

The unit must be disconnected from the mains (all poles) before opening the electronic housing lid.

The fuse is in the power electronics (16) beneath the electronic housing lid.

This fine fuse must always be replaced with a fuse of the same type: 10 A, slow, interrupting capacity "H".

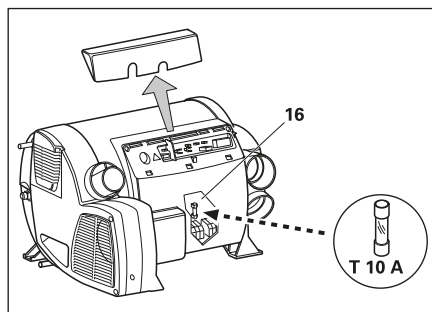
**Overheating protection 230 V**

The 230 V heating facility has a mechanical overheating switch. If the 12 V power supply is interrupted during operation or during the after-run period, for example, the temperatures within the unit could activate the overheating protection.

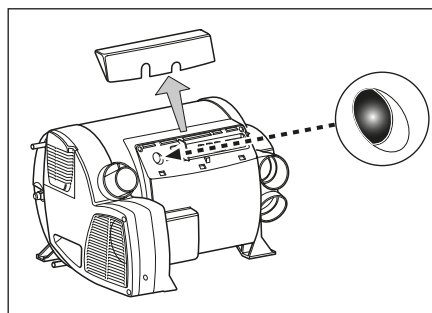

To reset the overheating protection, allow heater to cool, remove connection cover and press red reset button.

**Technical data**

determined in accordance with EN 624 or Truma test

**Device category**

I3 B/P in accordance with EN 437

**Type of gas:** Liquid gas (propane / butane)

**Operating pressure:** 30 mbar (see type plate)

**Water contents:** 10 litres

**Heating up time from approx. 15° C to approx. 60° C**

Boiler approx. 20 minutes (measured according to EN 15033) Heater + boiler approx. 80 min.

**Water pressure:** max. 2.8 bar

**Rated thermal output (automatic output levels)**

Combi 4 E: 2000 W / 4000 W

Combi 6 E: 2000 W / 4000 W / 6000 W

**Electrical operation**

Combi 4 E / Combi 6 E: 900 W / 1800 W

**Mixed operation (gas and electrical)**

Combi 4 E: max. 3800 W

Combi 6 E: max. 5800 W

**Gas consumption**

Combi 4 E: 160 – 320 g/h

Combi 6 E: 160 – 480 g/h

Readiness-heat power requirement

Combi 4 E / Combi 6 E:

Gas operation 5.2 g/h

**Air delivery volume (free-blowing without hot-air pipe)**

Combi 4 E: with 3 hot-air outlets max. 249 m³/h

with 4 hot-air outlets max. 287 m³/h

Combi 6 E: with 4 hot-air outlets max. 287 m³/h

**Current input at 12 V**

Combi 4 E: Short-term max. 5.6 A (average power consumption 1.1 A)

Combi 6 E: Short-term max. 5.6 A (average power consumption 1.3 A)

Heating up of boiler: 0.4 A

Stand-by: 0.001 A

Heating element FrostControl (optional): maximum 0.4 A

**Current input of 230 V**

3.9 A (900 W) or 7.8 A (1800 W)

## TRUMA TROUBLESHOOTING

### Troubleshooting

Fault	Cause	Rectification
After switching on (winter and summer operation) none of the LEDs are lit.	<ul style="list-style-type: none"> <li>- No operating voltage.</li> <li>- Device fuse or vehicle fuse defective.</li> </ul>	<ul style="list-style-type: none"> <li>- Check 12 V battery voltage, charge if necessary.</li> <li>- Check all electrical plug connections.</li> <li>- Check the unit or vehicle fuse and replace if necessary (see fuses).</li> </ul>
The green LED comes on when the unit is switched on, but the heater does not operate.	<ul style="list-style-type: none"> <li>- The temperature setting on the control panel is lower than the room temperature.</li> </ul>	<ul style="list-style-type: none"> <li>- Select higher room temperature at the control panel.</li> </ul>
After the heater is switched on, the green LED is lit and the red LED blinks.	<ul style="list-style-type: none"> <li>- Electronics are defective.</li> </ul>	<ul style="list-style-type: none"> <li>- Please contact the Truma Service Centre.</li> </ul>
Approximately 30 seconds after the heater is switched on, the red LED is lit.	<ul style="list-style-type: none"> <li>- Gas cylinder gas shut off valve at the manifold is closed.</li> <li>- Combustion air infeed or exhaust outlet is sealed.</li> </ul>	<ul style="list-style-type: none"> <li>- Check gas supply and open valves.</li> <li>- Inspect openings for contamination (slush, ice, leaves, etc.) and remove contamination if necessary.</li> </ul>
After operating for a longer period of time, the heater switches to failure.	<ul style="list-style-type: none"> <li>- Summer operation with empty water tank.</li> <li>- Hot-air outlets blocked.</li> <li>- Recirculated air intake blocked.</li> <li>- Gas pressure regulator iced up</li> <li>- Butane content in the gas cylinder too high.</li> </ul>	<ul style="list-style-type: none"> <li>- Switch device off and allow to cool. Fill boiler with water.</li> <li>- Check individual outlet apertures.</li> <li>- Remove blockage from recirculated air intake.</li> <li>- Use regulator heating (EisEx).</li> <li>- Use propane (at temperatures below 10 °C in particular, butane is unsuitable for heating purposes).</li> </ul>

Green and red LEDs blink after heater is switched off.	<ul style="list-style-type: none"> <li>- Unit was switched off during failure. After-running is active in order to reduce the unit's temperature.</li> </ul>	<ul style="list-style-type: none"> <li>- After-running will switch off after a few minutes. Only at that time will a failure reset be possible (switch off and then back on).</li> </ul>
Green LED blinks after heater is switched off.	<ul style="list-style-type: none"> <li>- After-running is active in order to reduce the unit's temperature.</li> </ul>	<ul style="list-style-type: none"> <li>- No failure. After-running will switch off after approximately 5 minutes.</li> </ul>
When the device is switched on in electrical operation the red LED on the control panel flashes, the yellow LED on the power selector switch does not illuminate and the heater does not heat up.	<ul style="list-style-type: none"> <li>- No 230 V operating voltage.</li> <li>- 230 V fuse defective.</li> <li>- Overheating protection has activated.</li> </ul>	<ul style="list-style-type: none"> <li>- Check 230 V operating voltage.</li> <li>- Check 230 V fuse and replace if necessary.</li> <li>- Reset overheating protection. Allow heater to cool, remove connection cover and press reset button.</li> </ul>







**If these measures do not remove the failure, please contact the Truma Service Centre.**



### ALDE COMPACT 3010 QUICK START GUIDE

Use the Left < and Right > arrow keys to move across the symbols. Highlight the required symbol so that it flashes. You can then adjust the function.

Use the +/On and -/Off keys to adjust settings and turn functions On and Off.

- On** With 'On' displayed the boiler is in standby mode and ready to be given commands.
- Off** With 'Off' displayed the boiler is shutdown.
-  Select your desired room temperature.
-  30 min hot water booster, with this function 'On' the circulation pump for the heating is turned off.
-  Select 'On' to operate the boiler LPG.
-  Select 1kW or 2kW to operate the boiler on 230V Electric.
-  Indicates that the circulation pump is operating for central heating.
-  Indicates that 230V is supplied to the boiler.

### PRE-START CHECKS

- Ensure the system is filled with Glycol before starting the boiler, check the expansion tank level. The fluid should be 10mm above the minimum mark when cold.
- Ensure adequate LPG Propane, 230V and 12V supplies are connected and turned on. The control panel should be active and display the 230V connection symbol.
- Turn the boiler 'On' using the control panel, then scroll across and raise the desired room temperature to +30°C. The circulation pump symbol should appear. Visually check in the expansion tank that the pump is operating.
- Scroll across and turn on the 2kW electric heater using the panel. Wait for 10 minutes and check that the upper flow pipe on the boiler is getting hot. The bottom return pipe may also be warm.
- Scroll back and turn on the gas burner using the control panel. You might not be able to hear it start, so visually check the flue outside to confirm the boiler is operating. Wait for 10 minutes and check the lower return pipe on the boiler. It should now be hot and the boiler fully operational.



### ALDE COMPACT 3010



**Please read these instructions carefully before using the boiler.**

Installation and repairs may only be carried out by a professional. National regulations must be adhered to.

### BOILER DESIGN

The boiler consists of three eccentrically- fitted cylinders (heat exchanger, water jacket for the heating system and, outermost, water jacket for hot water). The two outer pipes, and their ends and connections, are made of stainless steel, while the heat exchanger is made of aluminium.

The heat exchanger is divided into two semi-circles. The burner is located in the upper half, being the combustion chamber, and the combustion gases are expelled through the lower half. The burner unit is fitted on the end of the heat exchanger. It consists of a combustion fan, burner, solenoid valve and intake/exhaust connections. Two heating cartridges are fitted to the water jacket of the heating system. Maximum output is 2 or 3 kW, depending on model.

### DESCRIPTION OF FUNCTIONS

#### Using LPG

When LPG operation is selected on the control panel, the combustion fan starts. When the fan speed is correct, it signals the circuit board that the boiler can be lit. The circuit board sends ignition sparks to the spark plug at the same time as it sends electricity to the solenoid valve, which opens to allow gas in. The burner ignites, and a sensor transmits a signal back to the circuit board that the boiler is lit, and the ignition spark stops. The burner keeps burning until the boiler thermostat or the room thermostat reaches the set temperature reading.

Should the boiler go out for any reason, the sensor is activated and a new attempt is made to start the boiler (in about 10 seconds).

#### Using the heating cartridge

Electrical operation is selected on the control panel, the 12-volt relays on the circuit board trip, allowing the 230 volt supply to reach the electrical elements.

The heating cartridge is controlled in the same way as the gas boiler.

#### Warm water

When only warm water is required, for example during the summer, no settings need to be made, the boiler will look after this function automatically.

The pump will only start when the temperature in the vehicle is lower than the set temperature (see item 4, Control Panel). If the vehicle temperature is higher, the pump will not start.

## ALDE HEATING

**IMPORTANT INFORMATION**

- The boiler must not be started if there is no glycol in the system.
- The LPG boiler and heating cartridge may be operated in parallel.
- The heating system may be heated up without the warm water heater being filled with fresh water.
- Always switch off the main isolator for the boiler when the vehicle is not being used.
- Always drain the warm water heater of fresh water if there is a risk of frost.
- The LPG boiler must not be operated when refuelling the vehicle.
- When washing the vehicle, take care not to get water in the venting.

**The Domestic hot water heater**

The boiler is fitted with a built-in warm water heater with a volume of approx. 8.5-litres fresh water. The warm water heater can produce around 12 litres of 40°C water per half-hour (at a cold water temperature of 10°C). If the heating cartridges are used instead of gas for heating the boiler, the capacity is slightly reduced.

Always rinse out the heater before it is used, particularly if it has not been in operation for some time.

**Note:** The hot water is not intended for drinking or cooking. When the heater is in continuous use, it should be emptied approx. once a month, to ensure that a new air cushion is formed in the heater. The air cushion is essential for absorbing pressure surges in the heater.

**Note:** The warm water heater should always be drained of fresh water when there is a risk of frost and when the motorhome is not in use.

**Draining the heater using the combined safety/drain valve:**

1. Switch off the freshwater pump
2. Open all water taps.
3. Then open the safety/drain valve by raising the yellow lever (M) to a vertical position.
4. The heater will now drain directly below the vehicle through the safety/drain valve hose. Check that all the water is emptied out (about 7-10 litres). Leave the valve in the open position until the next time the heater is used.

**Note:** Check that the automatic check valve (N) is open and is allowing air to enter the heater when it is being drained, and that the hose is not blocked.

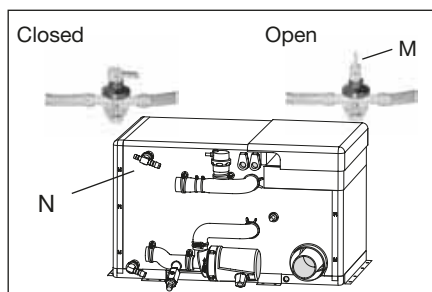
**THE HEATING CARTRIDGES**

All Compact 3010s are fitted with two 230V heating cartridges with a maximum output of either 2100 or 3150W. Select the heating cartridge output on the control panel.

Always check that the input supply to the vehicle has the correct amperage in relation to the selected output.

Note these ratings are for the boiler only.

- 1050W requires a 6 amp fuse/supply.
- 2100W requires a 10 amp fuse/supply.
- 3150W requires a 16 amp fuse/supply.

**THE CIRCULATION PUMP**

A circulation pump is required to circulate the heated glycol fluid. A 12V circulation pump is fitted in the expansion tank.

An optional 230V circulation pump can be fitted on the boiler. Selection of circulation pump is made with a switch on the control panel. The room thermostat on the control panel controls the circulation pump, i.e. switches it on or off according to the amount of heat required.

**SYSTEM TEMPERATURE**

The boiler is set to a system temperature of 80°C, i.e. the temperature of the glycol fluid as it circulates in the heating system.

**AIR CIRCULATION**

In order to achieve the best possible result from the principle of convected heat, it is important to allow air to circulate freely under bunks, and behind backrests and wall-mounted cabinets.

If the vehicle has a fitted carpet, ensure that the carpet does not obstruct the air supply to the radiators.

It is just as important that cushions or blankets do not interrupt the flow of air behind backrests and wall cabinets.

**MAINTAINING THE HEATING SYSTEM****WINTER CAMPING**

While camping during the winter, ensure that the flue is kept clear of snow and ice, since the inlet air to the LPG boiler enters through the flue. Do not start the LPG boiler until the flue is completely free of snow. A flue extension (part no. 3000 320) for fitting on the roof is recommended for winter camping.

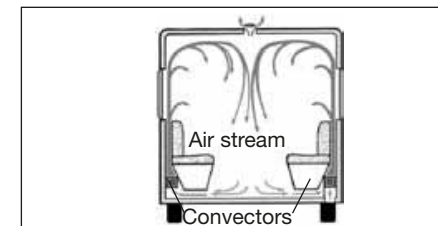
**THE HEATING SYSTEM**

Regularly check the heating system's fluid level in the expansion tank. The level should be about 1cm above the minimum indicator in a cold tank. The heating system should be filled with a mixture of water and glycol.

For preference, use high quality ready mixed glycol (with inhibitor) intended for use in aluminium heating systems.

If using concentrated glycol, the mixture should consist of 50% water and 50% glycol. Any vessels used for the liquid must be spotlessly clean, and the pipes in the heating system must be free of contamination. This will prevent the growth of bacteria in the system.

The glycol mixture should be changed every second year, since its ability to protect against corrosion, for example, will deteriorate. The glycol content should be checked before topping up with new liquid. This will ensure that the concentration of glycol in the mixture is not too high.

The warranty does not cover frost damage.

## ALDE HEATING

If the fluid level in the expansion tank falls for reasons other than evaporation, please check all joints, drain cocks and bleeder screws to ensure that they are not leaking. If the glycol-water mixture leaks out, rinse with water and wipe up.

Never allow the heating system to stand empty of glycol.

### FILLING THE SYSTEM WITH GLYCOL FLUID

**Note:** Any vessels used to carry the fluid must be spotlessly clean and the pipes in the system must be free of contamination. This will prevent the growth of bacteria in the system.

The system is filled through the expansion tank, either manually or using the Alde filling pump which both tops up and bleeds the system. For manual filling, unfasten the circulation pump nut (R) and lift the pump (S) out of the tank. Slowly pour the glycol mixture into the tank. Bleed the system.

Top up with more liquid if the level has fallen after bleeding. Bleed a newly filled system regularly during the first days the heating system is in operation.

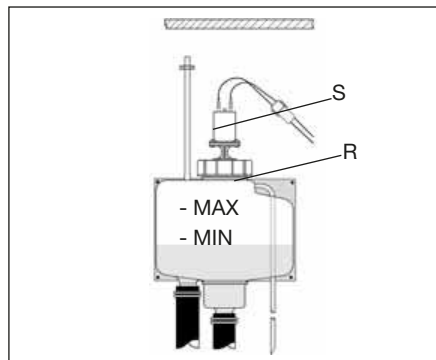

### BLEEDING THE SYSTEM

Depending on how the pipes have been fitted, air pockets may form when the system is filled with glycol fluid.

A sign that there is air trapped in the system is that the heat released into the pipes only extends a metre or so from the boiler even though the circulation pump is operating.

In newly-filled systems, small air bubbles can form in the expansion tank, creating a murmuring sound. If the circulation pump is stopped for a few seconds, the bubbles will disappear.

#### Bleeding:

The boiler is fitted with an automatic bleeder, valve to bleed air out of the boiler. Start the LPG boiler. The circulation pump should be switched off.

Open the bleeder screws in the system (please refer to the motorhome technical book for their locations). Leave the bleeder screws open until they start discharging fluid, and then close them. Start the circulation pump and let it run for a while. Check that the pipes and radiators around the vehicle are heating up.

#### If they still fail to heat up, try the following:

To help bleed the remaining trapped air place the vehicle on a sloping surface with the front end downwards. Then open the bleed screw at the highest point at the rear until it starts discharging fluid, then close the bleed screw. Turn the vehicle around and bleed the highest point at the front.

### FAULT FINDING

#### The boiler does not start

1. No LPG? Incorrect type for conditions?
2. Is the cylinder valve and gas shut off valve on the manifold open?
3. If the boiler has not been operated for some time, or if the gas cylinder has been changed, it may take longer than normal to light the boiler.
4. Check that the boiler is connected to the electricity supply (> 11V).
5. Check that the fuse (T) for the boiler is intact (See fuses on page 72).
6. Check whether the electric connections on the boiler are securely in position.

If none of the above helps, contact a service workshop.

#### The heating cartridge is not working

1. Check that there is an electricity supply (230V ~) to the heating cartridge.
2. Check that the relays fitted to the boiler come on (a slight click can be heard from the relays when the heating cartridge is switched on at the control panel).

If none of the above helps, contact your dealer or Alde - See page 9 for contact numbers.

### CONTROL PANEL – FUNCTIONS AND SYMBOLS

(Applies to control panels with program version 38 (06-17) or later, see item 17)

#### 0. The standby and on-position of the control panel

In standby, the functions which are activated in the boiler are shown, and there is no background lighting in the display. The control panel automatically goes to standby from the on position after two minutes if no buttons are pushed or if you step to standby (left of On/Off) with the arrow keys.

Start the on position by pressing any button. The background lighting comes on (blue light) and a function that can be set flashes. Select a function that can be set with the arrow keys. The settings are automatically saved.

1. The control panel is on standby and the heater is switched off.

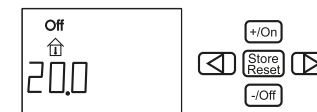

2. The control panel is on standby and the heater is operating.



#### 1. RESETTING THE SYSTEM

1. Press the Store/Reset button for 10 seconds. The control panel is reset to the factory setting.

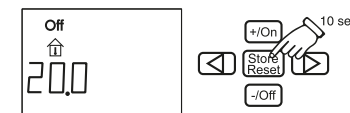

2. The main breaker to the control panel is in the "Off" position, Gas is on, Electricity at 1kW and 22°C.

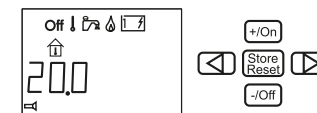

The pump is in automatic position. The lower menu row is not lit up.

# ALDE HEATING

## 2. START THE HEATER

Start the heating in the motorhome with the settings last used.

If you break the power to the heater, the settings which were last used will automatically be used when the power comes back on.

1. Press the button with the arrow until "Off" (main breaker) in the display flashes.

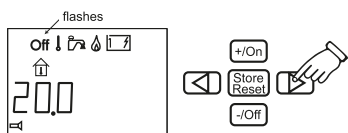

2. Press the +/On button. "On" (main breaker) in the display flashes.

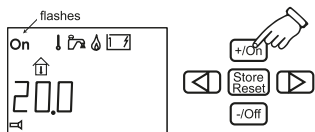

3. The settings are ready. "On" (main breaker) is shown in the display when the panel returns to standby.

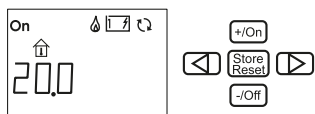

## 3. SWITCH OFF THE HEATER

1. Press the button with the arrow until "On" (main breaker) in the display flashes.

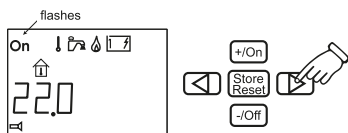

2. Press the -/Off button. "Off" (main breaker) in the display flashes.

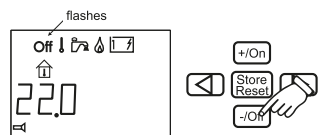

3. The settings are ready. "Off" (main breaker) is shown in the display when the panel returns to standby.

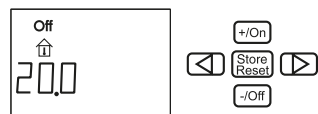

## 4. SET THE TEMPERATURE YOU WANT IN THE VEHICLE



The temperature of the vehicle can be set from +5°C to +30°C at intervals of 0.5°C.

1. Press the button with the arrow until the symbol for selecting temperature flashes.

The temperature shown is the temperature which is set at present (in this case 22.0°C).

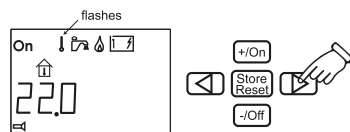

2. Increase the temperature by pressing the +/On button. Lower the temperature by pressing the -/Off button. The diagram shows that we have set the temperature at 25.0°C.

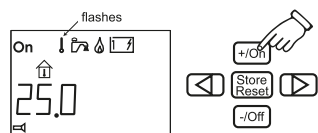

3. The settings are complete and the boiler is working at the set temperature.

## 5. WARM WATER



If you need more warm water you can increase the quantity temporarily for 30 minutes by increasing the water temperature from 50°C to 65°C.

When 30 minutes have elapsed, the water temperature returns to 50°C and the symbol goes out. When you have selected more warm water, the circulation pump stops.

1. Press the button with the arrow until the symbol for selecting warm water flashes. The "OFF" text is shown next to the temperature on the display.

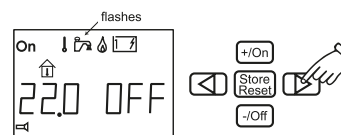

2. Switch the warm water on by pressing the +/ON button. The "ON" text is shown next to the temperature on the display.

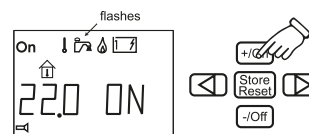

3. The warm water symbol is displayed when the panel returns to standby.

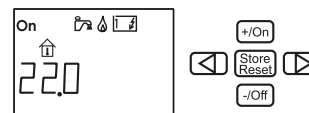

If you want you can switch off more warm water before 30 minutes have elapsed.

1. Press the button with the arrow until the warm water symbol flashes. The "ON" text is shown next to the temperature on the display.

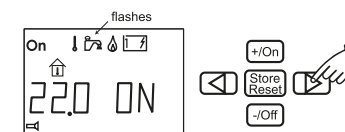

2. Switch off the warm water by pressing the -/Off button. The "OFF" text is shown next to the temperature on the display.

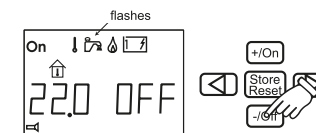

3. The warm water symbol goes out when the panel returns to standby.

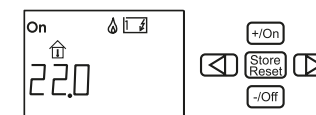

## 6. HEATING WITH GAS



Do as follows to activate heating with gas.

1. Press the button with the arrow until the gas heating symbol flashes. The "OFF" text is shown next to the temperature on the display.

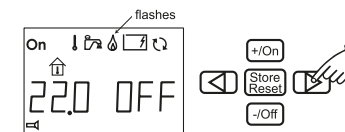

# ALDE HEATING

- Select gas heating by pressing the +/On button. The "ON" text is shown next to the temperature on the display.

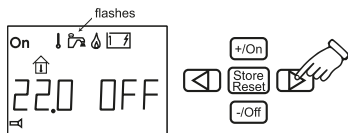

- The gas heating symbol is displayed when the panel returns to standby.

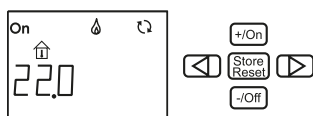

Do as follows to switch off the gas heating.

- Press the button with the arrow until the gas heating symbol flashes. The "ON" text is shown next to the temperature on the display.

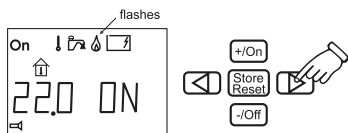

- Switch off the gas heating by pressing the -/Off button. The "OFF" text is shown next to the temperature on the display.

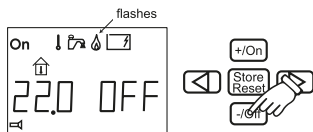

- The gas heating symbol goes out when the panel returns to standby.

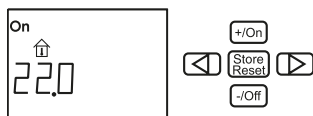

## 7. HEATING WITH ELECTRICITY



To activate heating with electricity. The greater the power the more rapid the heating will be.

- Press the button with the arrow until the electrical heating symbol flashes. The "OFF" text is shown next to the temperature on the display.

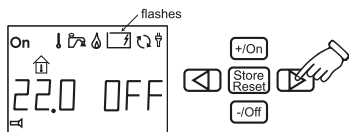

- Select power (1kW, 2kW or 3kW) with the +/On or -/Off buttons. The diagram shows that 3kW power has been selected (some boilers are only equipped with 1-2kW).

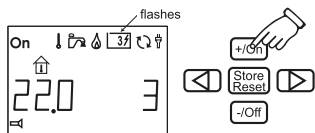

- The electrical heating symbol is shown when the panel returns to standby.

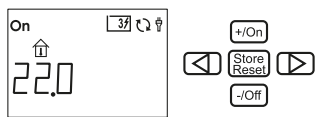

Do as follows to switch off heating with electricity.

- Press the button with the arrow until the electrical heating symbol flashes.

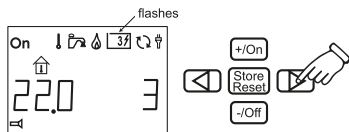

- Switch off the electrical heating by pressing the -/Off button until all power steps have gone out. The "OFF" text is shown next to the temperature on the display.

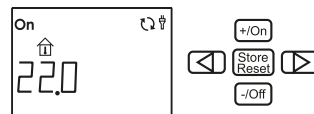

- The electrical heating symbol goes out when the panel returns to standby.

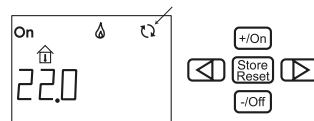

## 8. CIRCULATION PUMP



This symbol is displayed when the circulation pump is operating (12V-pump or 230V-pump).

When heating is required in the vehicle, the pump starts automatically.

The boiler selects the 230V pump if one is installed in the system. When the 230V is disconnected from the vehicle the 12V pump is automatically selected. The symbol will light up even if the pump is defective.

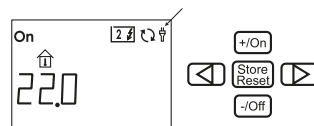

## 9. 230V CONNECTION



This symbol lights up when 230V is connected to the vehicle.

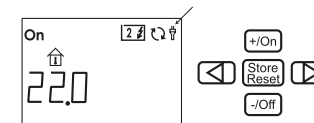

## 10. TEMPERATURE



This symbol shows the indoor temperature in the motorhome in intervals of 0.5°C.



This symbol shows the temperature outside the motorhome in intervals of 1°C. To use this function an outdoor temperature sensor must be installed.

## 11. WORKING WITH THE LOWER MENU ROW



The lower menu row can be used for such things as setting the clock, external start, night temperature, automatic start of the heater. To use the lower menu row you must activate it by doing as follows:

- Press the button with the arrow until the symbol for the lower menu row flashes.

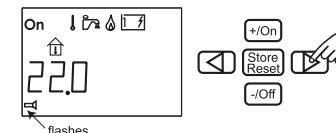

ALDE HEATING

- Light up the menu row by pressing the +/- On button. The lower row with symbols lights up.

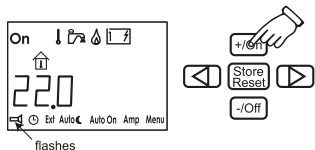

- To switch off the lower menu row, press the -/Off button when the symbol flashes. Activated functions will be displayed even if the lower menu row is switched off.

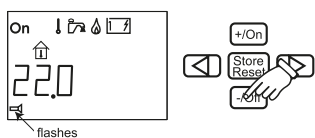

12. CLOCK



To set the clock, first light up the lower row of functions (see item 11).

- Press the button with the arrow until the clock symbol flashes.

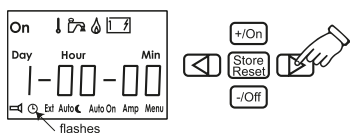

- Press the +/-On button. Day flashes. Use +/-On or -/Off to set the weekday.

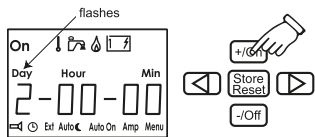

- Step forward with the arrow key until the time is displayed. Hour flashes. Use +/-On or -/Off to set the full hour.

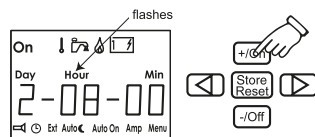

- Then step forward with the arrow key until the minutes are displayed. Min flashes. Use +/-On and -/Off to set the minutes.

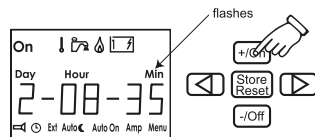

- Press Store and the time you have set is stored. The example shows Tuesday, 08.35.

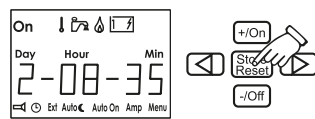

If the power to the panel is broken and the battery backup is not connected, the clock must be set again.

Weekday: 1-7

1=Monday

7= Sunday

Hours: 0-23

Minutes: 0-59

13. EXTERNAL START

EXT

This function is used if you wish to start the heater in the motorhome from outside. To use this function it is necessary to have the external start function option fitted. To activate external start, first light up the lower menu row of functions (see item 11).

- Press the button with the arrow until the "Ext" symbol flashes. The "OFF" text is shown next to the temperature in the display.

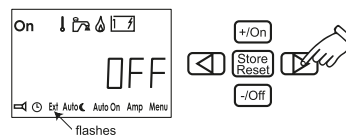

- Press the +/-On button. The "ON" text is shown next to the temperature in the display.

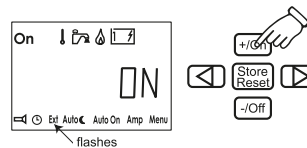

- Press the button with the arrow until the On symbol (main breaker) flashes. Press -/Off.

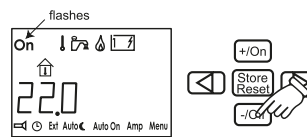

- Off and Ext are shown in the display when the panel returns to standby. External start is activated.



the heater, the display will not light up until 12V is connected. The external start function is still activated.

To switch off external start, go to the "Ext" symbol in the on position and press the -/Off button.

14. AUTOMATIC TEMPERATURE CHANGE

This function is used when you wish to set automatic temperature change, for example, during the night.

In order to activate automatic temperature change, first light up the lower row of functions (see item 11).

- Press the button with the arrow until the symbol for automatic temperature change flashes. The temperature and the "OFF" text are shown on the display.

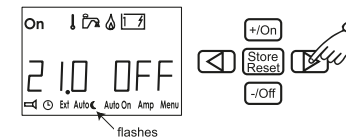

- Press the +/-On button. Set flashes and the OFF text is shown in the display. Press +/-On to activate the function. "ON" is shown in the display.

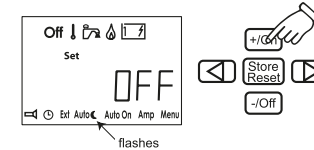

- Press the left arrow key. The required temperature is displayed. Then adjust the temperature by pressing the +/-On or -/Off button.

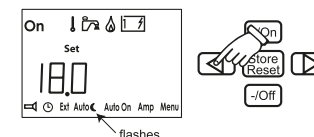

When external start is activated the heater will start with the latest settings and "ON" (main breaker) comes on. If 12V is not connected to

# ALDE HEATING

4. Then press Store and the start time is displayed. Adjust the start time (the same procedure as in 12) and press the "Store" button.

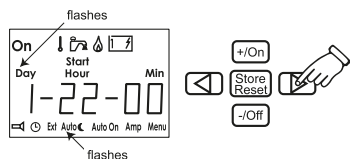

5. Now adjust the stop time and press "Store" again. The text field shows the required temperature and ON.

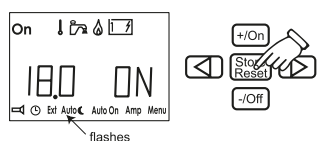

6. If you want the temperature change to be repeated daily, select day 0. Auto is shown in the display when the panel returns to standby.

## 15. STARTING THE HEATER AUTOMATICALLY

### AutoOn

This function is used if you want the heater to start automatically at a later time. The heater works for 24 hours and then stops.

Automatic start is repeated the following week as long as the function is activated.

To activate the function you must first light up the lower row of functions (see item 11).

The function controls the panel's main breaker.

1. Press the button with the arrow until the AutoOn symbol flashes. "OFF" is shown in the display. To activate AutoOn, press the +/- On button or the -/Off button to close the function.

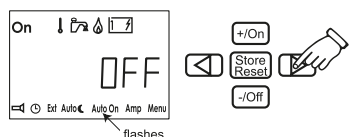

2. The start time will be displayed. Set the time in accordance with item 12 and press "Store" to store the settings. "OFF" is shown in the display.

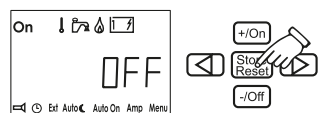

3. Press the +/-On button. On is shown in the display and AutoOn flashes. Set the panel's main breaker to OFF.

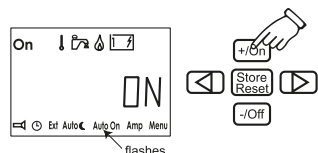

When you get to the vehicle and AutoOn is activated, de-activate AutoOn so that the heater does not stop after 24 hours (the boiler cannot be switched off when AutoOn is activated).

You can then step back with the left-hand button in the settings and press Store in all positions.

## 16. LOAD MONITOR

### AMP

This function is used if you do not want the 230V fuses to become overloaded. If the vehicle's total current consumption exceeds the set value, the boiler's electrical power will be automatically reduced. On account of voltage variations and tolerances, one can select various control levels (for example, for 6A fuse, one can choose either 5,6,7 Amp setting).

If the fuse does not hold, select a lower set value. The function is disconnected in the factory setting. To activate the function, you must first light up the lower row of functions (see item 11).

1. Press the button with the arrow until the Amp symbol flashes. "OFF" is shown in the display.

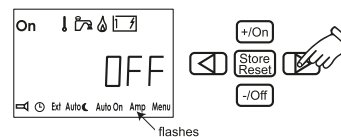

2. Press the -/Off button to activate and set the function. The following values can be set with +/-On or -/Off buttons, 5,6,7,9,10,11,15,16,17.

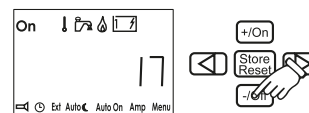

3. Amp is shown in the display when the panel returns to standby.

## 17. MENU

### Menu

In the "Menu" setting one can activate a number of functions. To activate the function you must first light up the lower row of functions (see item 11). To step between the various functions, use the arrow keys.

OFFSET (Temperature adjustment)

With this function you can calibrate the temperature on the panel if you notice that the temperature (the stabilised room temperature) does not correspond with the temperature shown on the panel.

1. Press the button with the arrow until the Menu symbol flashes. Press +On.
2. When OF is displayed, adjust the temperature displacement with +/-On or -/Off (+/-5°C in intervals of 0.5°C).

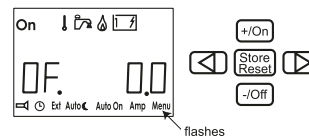

3. Press Store to leave the OFFSET function.

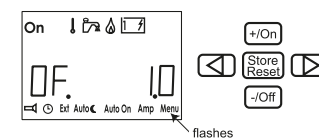

## PUMP 12V/PUMP AU.

The 12V pump is used in the PU 12 setting even if 230V is connected. In the PU AU position, the 230V pump works, and when 230V is disconnected, the 12V pump starts. The PU AU function is activated in the factory setting.

1. Press the button with the arrow until the Menu symbol flashes. Press +On.
2. When OF is displayed, step with the arrow key until PU AU is displayed. Press +/-On and PU 12 is displayed.

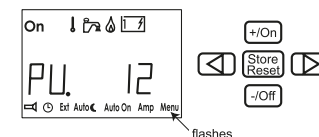

3. Press -/Off and PU AU is displayed. Press Store to leave the pump function.

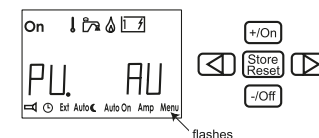

# ALDE HEATING

## SERVICE

With this function one can see what values\* from the heater are displayed. The values are updated once per second.

1. Press the button with the arrow until the Menu symbol flashes. Press +On.
2. When OF is displayed, step with the arrow key until SE is displayed. Press +/On to see the various values (-/Off can also be used).

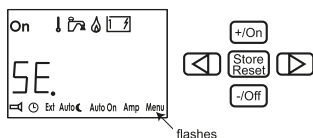

3. To leave Service, press Store.

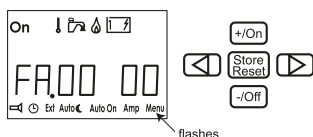

\* The values shown during service are:

**FA (revolutions):** The speed of the fan divided by 2.

**SH (temp):** Warm water temperature.

**HE (temp):** Operating temperature.

**OH:** If the overheating protection has been tripped On or alternatively Off.

**HS (X):** Software version in the heater.

**PS (X):** Software version on the panel.

**I:** Amp. Guideline value shown in steps of 0.5 A.

**WI:** Window breaker on-off.

**ES:** External start on-off.

**10-RS:** Heater information, only for ALDE.

## BUTTON SOUND

With this function you can connect or disconnect the button sound to the buttons. The button sound is disconnected in the factory setting.

1. Press the button with the arrow until the Menu symbol flashes. Press +On.
2. When OF is displayed, step with the arrow key until Sn is displayed. Press +/On and the button sound is connected.

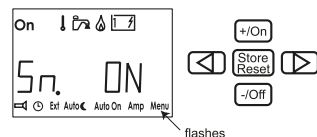

3. Press -/Off to disconnect the button sound. Then press Store to leave the button sound function.

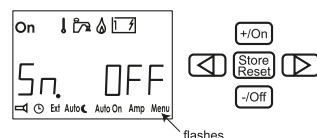

## CONSTANT PUMP OPERATION

With this function, selected pump is in constant operation. The function is disconnected in the factory setting. This function limits the hot water supply, particularly when there is little need of heat.

1. Press the button with the arrow until the Menu symbol flashes. Press +On.
2. When OF is displayed, step with the arrow key until PE is displayed. Press +/On and constant pump operation is connected.

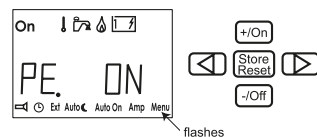

3. Press -/Off to disconnect constant pump operation. Then press Store to leave the pump operation function.

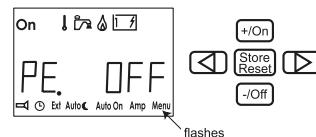

## AUTOMATIC TEMP. INCREASE

At 02.00 hours (night time) the boiler starts and works in accordance with Warm water (item 5) if the clock is set. The reason for this is to reduce the risk of legionella.

The function is disconnected in the factory setting.

1. Press the button with the arrow until the Menu symbol flashes. Press +On.
2. When OF is displayed, step with the arrow key until LE is displayed. Press +/On and legionella is connected.

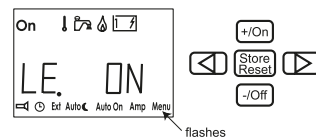

3. Press -/Off to disconnect legionella. Then press Store to leave the legionella function.

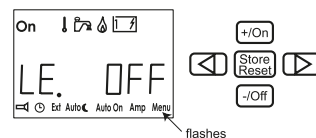

## 18. FAULT MESSAGES

When a fault occurs in the system the reason is shown in the display.

**LOW BAT:** If the vehicle has a battery voltage of less than 10.5V, the heater stops. The heater is automatically reset when the voltage comes up to 11V.

**FAN:** Faulty fan speed. Automatic resetting after 5 minutes.

**GAS OUT:** Gas finished. Resetting by switching off and restarting the boiler in accordance with item 1.

**OHEAT 1:** Overheating protection tripped. To re-set, disconnect 12V from the boiler and connect again.

**OHEAT 2:** Thermostat tripped. To re-set, disconnect 12V from the boiler and connect again.

**WINDO:** Window open, the boiler stops for gas. Gas operation in the boiler starts when the window is closed. Electrical operation functions. Check the vehicle instructions to see whether this function is installed.

**SERIAL:** There is a connection fault between boiler and panel. Normally, this is a mechanical fault in the connection between the heater and panel. To re-set, break the main current and then start again.

## 19. EMERGENCY START

- Disconnect 12V and the cable to the panel on the heater.
- Connect a cable between 2 and 9 in the contact device (on the heater).
- Connect 12V to the heater.

Now the heater starts with gas and 1kW. (Regulation of room temperature does not function, constant pump operation)



**ALDE TECHNICAL DATA****Measurements/Weights**

Boiler height:	310mm
Boiler depth:	340mm
Boiler width:	510mm
Weight:	14kg (without fluid)

**Gas Propane Butane**

Output 1:	3.3kW	3.8kW
Consumption	245g/h	275g/h
Output 2:	5.5kW	6.4kW
Consumption:	405g/h	460g/h
Pressure:	I3+ 28-30/37 mbar I3B/P 30 mbar	

**Volume/Pressure/Temp**

Liquid volume radiator water:	3.5 litre
Liquid volume warm water:	8.4 litre
Max pressure radiator water:	0.05MPa (0.5 bar)
Max pressure warm water:	0.3MPa (3.0 bar)
System temperature:	max 85°C

**230V ~**

Output element:	1 x 1050W
Output element (2 or 3kW):	1 x 2100W

**12V DC**

Current consumption:	1 amp (max)
Fuse:	3.15 amp+ / 3.15amp-

**THETFORD ABSORPTION REFRIGERATORS**

This user's information is for Thetford absorption refrigerators. It explains how to use your refrigerator correctly and safely. Read these instructions and the Thetford manual carefully before using the refrigerator for the first time to obtain a quick overview of how to operate and use the refrigerator.

Thetford absorption refrigerators are specially designed to store fresh and frozen food and make ice cubes in caravans and motorhomes. The control panel allows you to select the preferred energy source and cooling level. Different energy sources allow you to use your refrigerator under different conditions.

Thetford absorption refrigerators belong to category C11: gas appliances that must be installed so that the combustion area is isolated from the living space.

To find out more about how your absorption refrigerator works, visit the website at [www.thetford-europe.com](http://www.thetford-europe.com).

**Precautions and safety instructions****Alerts**

The following alerts are used in this user's manual:

**Warning!** "Warning" alerts the user to the danger of damage to the product or to the user if the user fails to carry out the described procedures carefully.

Non-observance of the procedures may result in serious injury to the user or damage to the product.

**Caution!** "Caution" alerts the user to the possibility of damage to the product if the user fails to carry out the described procedures carefully.

**Important!** "Important" denotes supplementary information for the user and alerts the user to potential problems.

**Warnings**

- This refrigerator must be installed according to the manufacturer's instructions and in compliance with local and national regulations.
- Read this manual carefully before you start to use your refrigerator.
- Always consult the warnings before you perform any maintenance or gas checks.

**Repairs/maintenance**

- Never open or damage the cooling system. The cooling system is pressurised and contains substances harmful to health.
- Never attempt to repair gas, extractor or electrical parts yourself. They must be repaired by a qualified service engineer. Contact the Customer Service department of Thetford for a list of qualified parties.
- Always switch off the refrigerator before you perform any kind of maintenance or cleaning.

**Use**

- Never cover the ventilation grills in the walls of a motorhome. Good ventilation is essential for the correct working of the absorber system.
- Water in the ventilation grating can result in damage to the refrigerator. Therefore, we advise that you put the winter cover over the ventilation gratings prior to washing your vehicle.
- Never expose the refrigerator to rain.
- Never operate the refrigerator by gas while driving. If a road accident results in fire, there is a risk of explosion.

**What to do if...**

- You smell gas:
  - close the valve of the gas bottle;
  - extinguish any naked flames;
  - do not switch on any electrical devices or lighting;
  - open the windows and leave the room;
  - contact the Customer Service department of Thetford.
- You suspect a leak in the cooling system:
  - switch off the refrigerator;
  - extinguish any naked flames;
  - provide sufficient ventilation;
  - contact the Customer Service department of Thetford (see page 9 for contact details)

**About your refrigerator**

Your refrigerator has a cold space and a freezer compartment. After starting up the refrigerator, allow it to cool for at least eight hours before placing any food in it.

**Cold space**

The cooling fins are located on the inside of your refrigerator. The absorption system uses the cooling fins to withdraw heat from the refrigerator. Therefore, never place plastic or paper over the cooling fins. Air must be able to circulate freely through the refrigerator so that heat can be extracted.

**Important!** Do not cover the cooling fins at the back of the refrigerator with plastic or paper. The refrigerator cools optimally when air is allowed to move freely through the refrigerator.

- To limit frosting on the cooling fins:
  - always cover liquid foods before placing them in the refrigerator;
  - always let hot food cool before placing it in the refrigerator;
  - never keep the refrigerator open longer than necessary.

## THETFORD REFRIGERATORS

**Fitting racks**

Inside your refrigerator there are two or three storage racks. You can adjust the racks to a convenient height by means of a simple click system:

- click the plastic bracket to the right short side of the rack;
- turn the bracket into the horizontal position and insert the rack tipped in a sloping position into the refrigerator;
- place the short side without bracket into one of the grooves on the left wall of the refrigerator;
- place the short side with bracket in the corresponding groove on the right wall of the refrigerator;
- turn the bracket downwards to fix it into the groove.

To move a rack, turn the bracket upwards and remove the rack. Place the rack at the required height in the way described above.

**Note:** the fridge requires cooling using 230v or gas before turning to 12v. 12v operation will keep the fridge and contents cool when driving but will not cool them down from warm.

**Securing products for driving**

The fitting racks in your refrigerator have a system for you to secure products while driving. The system consists of a simple click-and-slide plastic strip. To secure products on the rack while driving, push the plastic strip as tightly as you can against the products on the rack. In the storage space on the inside of the refrigerator door, there are two unique Thetford bottle slides (see illustration). The slides prevent bottles from sliding around during driving. Push the slide against the products in the door or place the products between the bottle slide .

**Freezer compartment****Important!**

- The freezer compartment is unsuitable as a means of freezing food, the freezer will maintain the temperature of already frozen food
- Use only drinking water to make ice cubes.
- Do not place any other products in the freezer compartment when you are making ice cubes.
- Water freezes fastest with the thermostat at the highest setting.

**Tip! Make ice cubes at night when your refrigerator has more spare capacity.**

**Door locking mechanism**

The refrigerator door has an automatic locking mechanism. The door locks automatically when you press it shut firmly. This automatic locking mechanism also keeps the refrigerator door shut during driving. For some models an additional security device is fitted below the refrigerator. By pushing the locking bar over the pin when the door is closed, you can be sure that the door does not open during your journey.

If you are not going to use the refrigerator for a prolonged period of time, you can use the special storage latch of the door locking mechanism (see illustration) to prevent odours. Rotate the hook through 90 degrees and lock it in place using the strike plate.

**Delux refrigerators operation (control panel illustrations 5 and 6)**

- It is recommended to clean the inside of the refrigerator before you switch it on.
- Let the refrigerator cool for at least eight hours before you place food in it for the first time.



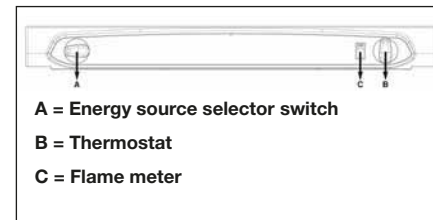

**Igniting and starting your refrigerator****Manual ignition: ILLUSTRATION 5**

- A = Energy source selector switch**
- B = Thermostat**
- C = Flame meter**
- D = Manual ignition (piezo electric ignition)**

**Electric ignition: ILLUSTRATION 6**

- (a) The refrigerator can be powered by the mains (230V), direct current (12V) or liquid gas. Select the energy source that you want by means of the energy source selector switch (A).

The switch has four settings:

- direct current (DC) (12V) 
- mains supply (230V) 
- gas 
- switched off 

- (b) The thermostat controls the refrigerator temperature when the refrigerator is powered from the mains (230 V) or gas. The refrigeration level is indicated by the dots (the bigger the dot, the colder the setting).

- (c) The flame meter shows whether the flame is alight. The flame is alight when the red needle of the meter moves into the green area.

- (d) Pressing the manual (piezo electric) starter produces a spark that ignites the flame in the burner.

**Electrical operation**

The refrigerator can be powered by electricity in two ways:

- DC (12V): Set the energy source selector switch (A)  to the refrigerator will now be powered by the battery of your car or camper.

## THE FORD REFRIGERATORS

**Important:** Always use the gas connection or mains voltage to start up the refrigerator for the first time and to cool it. Powering from the battery of your vehicle is suitable only for maintaining the temperature of the refrigerator and its contents once it has been refrigerated.

- When powered by a vehicle battery (12V) the refrigerator works without temperature control (i.e. constant operation).
- Mains voltage (230V): set the power selector switch (A) to
- Set the temperature by means of the thermostat, rotary switch (B). (The bigger the dot, the colder the setting).

### Powering with gas

**WARNING!** - Flammable material must be kept away from the rear of the refrigerator.

- For selection of gas type, see the information plate inside your refrigerator.
- For the pressure regulator model, see the information plate inside your refrigerator and the table at the back of this booklet.
- The type of gas container and its location must be in compliance with the most recent regulations. Ensure that the unit is installed in a location with good ventilation and make sure that the ventilation openings in the gas container storage location remain open.
- The changing of the gas container must be done outside in the open air and out of reach of any possible sources of ignition.
- It is prohibited to use gas to power the refrigerator while you are driving.
- It is prohibited to use gas to power the refrigerator in the vicinity of petrol stations. Open the valve of the gas bottle and the gas taps.
- Set the thermostat (B) to the highest level (the biggest dot)
- Set the energy source selector switch(A) to ignite the gas flame:

### Manual ignition

- Press the thermostat (B), and keep it depressed.
- Press the button for manual ignition several times at intervals of between 1 and 2 seconds.
- Release the thermostat when the indicator of the flame meter enters the green area. If it does not enter the green area, repeat the previous step.

**Warning:** Never keep the thermostat depressed for longer than 30 seconds. If a flame does not appear, wait at least five minutes before trying again. If you fail to observe this rule, there may be an accumulation of gas creating the risk of fire or explosion.

- Set the desired refrigeration level by means of the thermostat (B). (The bigger the dot, the colder the setting)

### Electrical ignition (illustration 6)

- Press the thermostat (B) and keep it depressed.
- Ignition takes place automatically. You will hear a ticking noise. If ignition was successful, the noise will stop and the flame meter will turn green. Release the thermostat.
- If the flame goes out, ignition will be repeated automatically.
- Set the desired refrigeration level by means of the thermostat (B). (The bigger the dot, the colder the setting)

### Switching off the refrigerator

- Set the energy source selector switch (A) to switch off .
- The refrigerator is now completely switched off.
- Use the special storage latch on the door locking mechanism to stop the door from closing. This prevents unpleasant odours and mould in the refrigerator.

**Important:** If you are not going to use the refrigerator for a prolonged period, close the valve of the gas bottle and the gas taps.

### Premium LCD refrigerator operation (control panel, ILLUSTRATION 7)

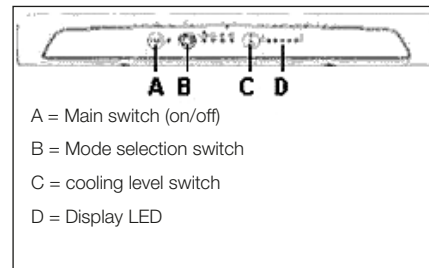

- It is recommendable to clean the inside of the refrigerator before you switch on the refrigerator.
- Let the refrigerator run for at least eight hours before you place food in it for the first time.



There are two types of LCD refrigerators:

Electric and Automatic. Automatic LCD are supplied with the SES system, which allows the consumer to switch the refrigerator in AUTO mode which allows the refrigerator to automatically select the best power source.

### Smart Energy Selection (SES)

When you start up a refrigerator equipped with Smart Energy Selection (SES) you should usually select the AUTO mode. The SES system will then automatically select the best of the three available energy sources.

The system will apply the following priority:

- mains voltage (230V) 
- direct current (12V) 
- liquid gas 

If an energy source becomes available that has a higher priority than the source the refrigerator is currently using (e.g. if your vehicle engine is started), the system will stop using the current energy source and switch to the energy source

with the higher priority.

If a fault occurs in one or more of the possible energy sources, the system will not generate an error message while an alternative energy source is still available. The SES system switches over automatically.

If none of the energy sources are available, the blue LED flashes every second and an error code is shown on the display.

Automatic modes additionally allow you to select the desired energy source manually.

### Switching on the refrigerator

**Important:** The memory of the SES system saves every change made to the setting. Consequently, the SES system will start up on each subsequent occasion in the last selected setting.

### ILLUSTRATION 8

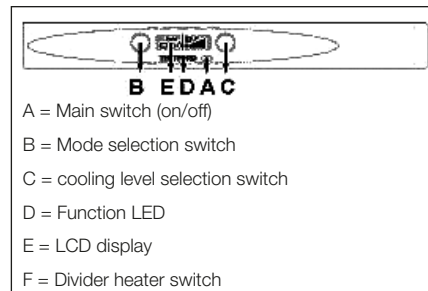

1. Open the valve of the gas bottle.
  2. Open the taps of the gas supply.
  3. Press main switch (A). The function LED will turn blue and all symbols on the LCD display will light up.
  4. Use the mode selection (B) switch to select the 'Auto' function or one of the power supplies that you want. The LCD display will show the option you have selected.
  5. Set the desired refrigerating cooling level by means of the cooling level selection switch (C). The LCD will show the cooling level setting you have selected.
- (a) Use the main switch to switch the

refrigerator on and off. The function LED will turn blue. The display LCD shows the most recent settings. After 10 seconds the LCD displays backlight will go out. The function LED remains blue.

(b) Press the mode selector switch and the display LCD display backlight will show the setting for 10 seconds. Pressing the mode selector switch successive times take you through the menu in the following sequence AUTO, manual DC (12V), manual gas, manual mains voltage (230V) and back to AUTO. Select either the AUTO option or one of the other power supplies that you want to use. The LCD display shows the option you have selected. If you select the AUTO option, the system will choose the most suitable power supply and the AUTO symbol and the symbol of the power supply chosen by the system will both be shown on the LCD display. Ten seconds after release of the mode selector switch, the system will switch off the LCD backlight.

(c) Use the cooling level selector switch to control the temperature of the refrigerator. When you press the cooling level selector switch, the LCD backlight will light up and show the currently set temperature. Every time you press the cooling level selector switch you set the refrigerator one position cooler. On reaching the coldest temperature, the system will start again at the warmest temperature setting. Ten seconds after release of the cooling level selector switch, the system will switch off the LCD backlight.

(d) Only the N145 and the N 150 fridges have a divider heater. By heating the metal plate between the freezer and the fridge cabinet, the divider heater prevent the ice forming when the freezer door is opened and also prevents the freezer door from freezing stuck to the metal breaker of the fridge. To save energy the divider heater can be switched off. The switch can be found on the side control panel near the latch.

**Powering with electricity**

Powering with electricity can be selected both by the Auto mode (only Automatic fridges) and

manually.

**Mains voltage (230V):**

This energy source will be selected if the mains voltage is greater than 200V. This power supply requires a continuous current of 12V to operate the electronic control system.

**Direct current (12V):**

(e) The SES system will select 12V powering only if a mains voltage (230V) is unavailable, the vehicle engine is running and a voltage higher than 11V is available. If a fault occurs during electrical powering (230V or 12V), an error message will not be shown on the display as long as another energy source is available. The system will automatically switch to the available energy source that has the highest priority.

**Selecting electrical power manually Mains voltage (230V):**

The LED on the main switch warns you whenever insufficient voltage is available or if a fault occurs. If this happens, the LED will start flashing once per second and an error code is shown on the LED display. When sufficient current is available again, or the fault has been resolved, the LED will emit a steady blue light again.

**Direct current (12V):**

- Always use a gas connection or mains voltage to start up the refrigerator for the first time and to cool it. Powering from the battery of your vehicle is suitable only for maintaining the temperature and its contents once it has been refrigerated.

The LED warns you whenever your vehicle's engine is not running, or if a fault occurs, or if insufficient voltage is available. If this happens, the LED will start flashing once per second and an error code is shown on the LCD display.

Once the engine is running, or the fault has been resolved, or sufficient voltage is available again, the LED will again emit a steady blue light.

**Note:** If the refrigerator has been manually set to operate at 12V, it will not automatically switch to another energy source when your vehicle's engine is not running. In this case, the refrigerator will stop cooling.

**Powering with gas**

Powering with gas can be selected both by the Auto mode (only Automatic fridges) and manually.

**Warning:** Flammable material must be kept away from the rear of the refrigerator.

- For selection of gas type, see the information plate inside your refrigerator.
- For the pressure regulator model, see the information plate inside your refrigerator and the table in the Thetford user instructions.
- The type of gas container and its location must be in compliance with the most recent regulations. Ensure that the unit is installed in a location with good ventilation and make sure that the ventilation openings in the gas container storage location remain open.
- The changing of the gas container must be done outside in the open air and out of reach of any possible sources of ignition.
- It is prohibited to use gas to power the refrigerator while you are driving.
- If a road accident results in fire, there is a danger of explosion
- It is prohibited to use gas to power the refrigerator in the vicinity of petrol stations.

**Auto mode**

The system will select gas operation if:

- mains voltage (230V) is unavailable;
- the vehicle's engine is not running.

Once mains voltage (230V) is available again or the vehicle's engine is running, the system will switch to the available energy source that has the highest priority if in the Auto mode.

If the refrigerator switches from 12V DC to gas operation when it is in auto mode, the system will wait for about 15 minutes before

igniting the gas. During this time, however, the gas indicator lamp will come on. The delay is built in to avoid it switching to gas operation whenever you stop to refuel your vehicle. You can cancel the delay by immediately switching the refrigerator off and then on again.

If the system selects gas operation, the ignition will be activated automatically. The gas will flow to the burner and be lit by the electric ignition. If the flame goes out, the gas will immediately be lit again.

**Selecting gas operation manually**

If the flame cannot be lit within 30 seconds, the gas supply will stop and gas mode will be switched off. The LED will start flashing every second and an error code is shown on the LCD display.

The gas mode can be reset only if the refrigerator is switched off. If you switch the refrigerator on again and the gas mode is still not working, the LED of the manual gas mode will flash to indicate that gas is unavailable and an error code is shown on the LCD display

**IMPORTANT ! It is prohibited to use gas to power the refrigerator while you are driving. If a road accident results in a fire, there is a danger of explosion. It is prohibited to use gas to power the refrigerator in the vicinity of petrol stations.**

**If it takes longer than 15 minutes to refuel your vehicle, you should switch the refrigerator off using the main switch (A).**

**Switching off the refrigerator**

- Push the main switch (A).
- The blue LED will go out.
- The refrigerator is now completely switched off.
- Use the special storage latch on the door locking mechanism to fixate the open door. This prevents unpleasant odours and mould in the refrigerator.

**N180**

The N180 is the first absorption fridge with three temperature zones. A freezer compartment (up to -180 C). A normal

cold section (approx 50 C) and a new cool section (approx 130 C) situated above the freezer compartment in the N180. This new cool section is ideal to store non-perishable products that are best stored in a cool place, like wine, butter, chocolate and bottled water.

### Maintenance

Regular maintenance is necessary to ensure the correct functioning of your refrigerator.

### Cleaning

**Tip!** A good time to clean your refrigerator is straight after you have defrosted it.

- Clean the refrigerator with a soft cloth and mild detergent.
- Dust the refrigerator with a soft, moistened cloth.
- Use a brush or soft cloth to remove once a year any dust from the condenser at the inside of the refrigerator.

**Important:** Do not use soap or aggressive detergents that are abrasive or soda-based.

- The removable interior components of the refrigerator are not dishwasher proof.

### Defrosting

Frost will gradually build up on the condenser of the refrigerator. You should defrost the refrigerator as soon as the frost layer is about 3 mm thick. Frost reduces the refrigerating capacity and life of your refrigerator.

- Remove the ice cube tray and all food.
- Switch off the refrigerator.
- Leave the refrigerator door open.
- Place dry towels in the refrigerator to absorb the water.
- Place trays containing hot water in the freezer compartment.
- After defrosting (when the freezer compartment and condenser are frost-free), remove the towels and the water trays and use a cloth to dry off the refrigerator.
- Switch the refrigerator on again in the

way described in section 4.1 ('Igniting and starting your refrigerator').

**Important:** Do not use force or sharp objects to remove frost.

- Do not try to accelerate defrosting by using (for example) a hair dryer.

### Door locking mechanism

Frost will form in the refrigerator if the door is not closed properly. To determine whether the door closes properly, close the door with a piece of paper between the door and the refrigerator. Pull at the piece of paper. If you feel resistance, the refrigerator door closes properly. If you feel no resistance, the door does not close properly. Perform this test regularly on all four sides of the refrigerator door.

If you find that the door does not close properly, check whether the door locking mechanism keeps the door properly shut.

### Winter operation

If you use the refrigerator when the outdoor temperature is below 8°C, install the Thetford vent winter/storage cover on the ventilation grills. The cover protects your refrigerator from excessively cold air. The winter cover is a refrigerator accessory obtainable from your motorhome dealer.

**Tip!** It is advisable to use the winter/storage cover if you are not going to use the vehicle for a long period of time.

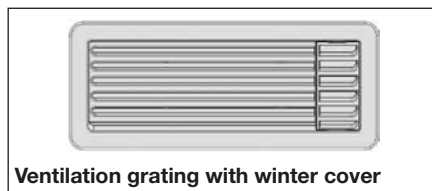

Ventilation grating with winter cover

**Important; do not use the winter/storage cover in temperatures greater than 8°C as this can damage the cooling unit at the rear of the fridge. Remove the covers and re-fit when placing the vehicle back into storage.**

### Maintenance of gas equipment

A qualified service engineer must maintain and inspect gas and electrical equipment. It is advisable to have this maintenance work performed by a customer service centre. Contact the Customer Service department of Thetford for a list of qualified parties.

Important! European laws covering gas appliances and extractors prescribe observance of the following rules (which are the user's responsibility):

- appliances that run on liquid gas must be inspected before being used for the first time and every year thereafter.
- the gas burner must be cleaned at least once a year or more frequently if necessary.
- If a gas hose is used, it must be checked annually. This hose has a limited life and, thus, must be regularly replaced. Check the hose regularly for cracks, splits and ageing. If in doubt, replace the hose. Pay attention to the maximum life of the hose and replace it in time, as advised by the manufacturer or in conformance with local regulations.
- For replacement, a gas hose approved in accordance with the local regulations must be used. Position the hose so that it can rotate, is not kinked, and will allow
- Due to the limited life of the gas hose, it must be installed so that replacement is possible.

### Maintenance checklist

This refrigerator will give you many years of trouble-free use if you simply run through the following checklist regularly:

- keep the refrigerator clean (see section 7.1 of the user instruction manual, 'Cleaning');
- defrost the refrigerator as often as is necessary (see section 7.2 of the user instruction manual, 'Defrosting');
- check the door closing mechanism regularly (see section 7.3 of the user instruction manual, 'Door locking mechanism');

- make sure that the ventilation grills are not blocked;
- Regularly clean the ventilation grills.

### Vent screen

The vent has a vent screen to prevent bugs from entering the combustion area of the refrigerators. These vents need to be cleaned regularly to insure a good airflow. When the refrigerator performs poor because of external circumstances such as extreme ambient temperatures, the vents can be removed to improve the airflow and improve the cooling performance of the refrigerators.

### Storage

If you do not expect to use your refrigerator for a lengthy period, carry out the following actions:

- Remove all food
- Switch off the refrigerator
- Clean the refrigerator as described in Section 7.1 'Cleaning'
- Shut off the gas tap to the refrigerator
- Leave the door of the refrigerator ajar using the special door closure hook (storage position)
- Place the winter protection on the ventilation grill.

### Troubleshooting

If your refrigerator does not refrigerate properly or will not start, run through the following checklist. If this fails to solve the problem, please contact the Customer Service Department in your country contact details on page 8 of the Thetford Manual

- Check whether you have followed the instructions in chapters 4, 5 or 6 of the user instruction manual ('Switching on the refrigerator').
- Check whether the refrigerator is on a level surface.
- Check whether the refrigerator can be used with an available energy source.

THETFORD REFRIGERATOR FAULT FINDING

Possible cause	Action you can take
<b>Problem: refrigerator will not work on gas</b>	
a) Gas bottle is empty.	a) Replace the gas bottle.
b) Valve of the gas bottle or the blue shut-off valve is closed.	b) Open the valve of the gas bottle or shut-off valve(s).
<b>Problem: refrigerator will not work on 12V DC</b>	
a) 12V fuse is defective.	a) Fit a new fuse (See page 71)
b) Battery is empty.	b) Test the battery and charge it.
<b>Problem: refrigerator will not refrigerate sufficiently</b>	
a) Insufficient ventilation for the refrigerator.	a) Check whether the ventilation gratings are covered.
b) Thermostat set too low	b) Increase the setting of the thermostat
c) Too much ice on the condenser.	c) Check whether the refrigerator door shuts properly and defrost the refrigerator.
d) Too much hot food stored simultaneously.	d) Let the food cool off first.
e) Gas burner is dirty.	e) Have the gas burner cleaned.
f) Door does not shut properly.	f) Check the door closing mechanism.

**Control panel diagnostics**

Refrigerators with a LCD control panel have a special diagnostics area which displays an error code if there is a fault.

- **Fault 1:** AC heater current is measured to be 75% below nominal current.  
Action: Contact your dealer or a Thetford Service Centre.
- **Fault 2:** DC heater current is measured to be 75% below nominal current.  
Action: Contact your dealer or a Thetford Service Centre.
- **Fault 3:** AC heater is ON when it should be OFF.  
Action: Contact your dealer or a Thetford Service Centre.
- **Fault 4:** DC heater is ON when it should be OFF.  
Action: Contact your dealer or a Thetford Service Centre.
- **Fault 5:** Senses flame when gas should be OFF.  
Action: Contact your dealer or a Thetford Service Centre.
- **Fault 6:** Senses gas output terminal ON when should be OFF.  
Action: Contact your dealer or a Thetford Service Centre.
- **Fault 7:** Senses gas output terminal OFF when should be ON.  
Action: Contact your dealer or a Thetford Service Centre.
- **Fault 8:** AC mains supply is 20% below nominal.  
Action: Your controls are in manual AC mode, but there is no power available. Check if you plugged in the 230V connection, if so the voltage supply on the 230V connection is too low, contact the power supplier.

- **Fault 9:** Gas lockout because flame fails to ignite after 30 seconds.  
Action: Your controls are in manual gas mode, but the flame fails to ignite. Check if your gas cylinder is empty or if one of the shut-off valves is closed. Select another energy source. Reset the fridge 3 or 4 times in gas-mode until flame ignites. Contact your dealer or a Thetford Service Centre if problem isn't resolved.
- **Fault 10:** No "engine running" signal is present and control is in Manual DC mode.  
Action: Your controls are in manual DC mode and the engine of your vehicle is not running. The refrigerator can only cool on 12V when the engine of your vehicle is running. Start the engine or select a different energy mode.
- **Fault 11:** No energy source is available and control is in AUTO mode.  
Action: Your controls are in AUTO mode, but no energy source is available. Start the engine, connect the 230V supply or open the gas supply and reset the refrigerator by turning it off and on again.
- **Fault 12:** Contact your dealer or a Thetford Service Centre.
- **Fault 13:** Thermistor fails; control automatically switches to Backup mode (BOS).  
Action: Check if the connector above the fin on the inside of the cabinet is correctly plugged in. If so contact your dealer or a Thetford Service Centre.
- **Fault 14:** Display Board and Power board lost communication with each other.  
Action: Contact your dealer or a The

## COOL BOX OPERATION

**Domestic Waeco CB-40 Cool Box**

The CB-40 is suitable for cooling and freezing foodstuffs. The Cool Box has an under-voltage protection mechanism. To protect the battery, the Cool Box switches off automatically if the voltage is insufficient. When the voltage is sufficient again, it switches on again.

**Note:** Before starting your new Cool Box for the first time, you should clean it inside and outside with a clean damp cloth for hygienic reasons. (see also “Cleaning and maintenance” below).

**Operating the Cool Box**

Switch the Cool Box on by turning the control knob to the right. (Fig 1.) After switching on, it takes approximately 60 seconds before the compressor starts up.

The desired temperature can be set by adjusting the control knob between minimum (warmest) and maximum (Coolest). Ensure that the objects placed in the Cool Box are suitable for cooling to the selected temperature.

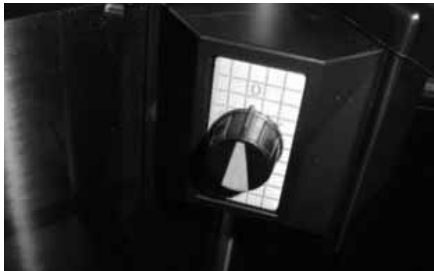

Fig 1.

**Warning:** Ensure that food or liquids in glass containers are not excessively refrigerated. Liquids expand when they freeze and can thus destroy the glass containers.

The cooling capacity can be influenced by

- The ambient temperature,
- The amount of food to be conserved,
- The frequency with which the lid is opened.

The temperature in the Cool Box varies from the top to the bottom. The warmest at the top just under the lid and the coolest at the bottom immediately over the base.

**Conserving foodstuffs**

You can conserve foodstuffs in the Cool Box compartment. The time for which the food can be conserved in this way is usually stated on the package. Observe the temperature information and best before date on the food packaging.

**Note:** Food which can easily absorb tastes and odours, and liquids and products with a high alcohol content, should be conserved in airtight containers.

**Warning:** Do not re-freeze products which are defrosting or have been defrosted; consume them as soon as possible.

**Defrosting the Cool Box.**

Humidity can form frost in the interior of the Cool Box or on the vaporiser. This reduces the cooling capacity. Defrost the device in good time to avoid this.

**Warning:** Never use hard or pointed tools to remove ice or loosen objects which have frozen in place.

1. Take out the contents of the Cool Box.
2. Place them in another Cool Box to keep them cool, if necessary.
3. Set the knob to “0”.
4. Leave the lid open.
5. Wipe off the defrosted water.

## COOKER OPERATION

**COOKER 3 BURNER WITH COMBINED GRILL AND OVEN / COOKER 3 BURNER + ELECTRIC HOTPLATE WITH SEPARATE GRILL AND OVEN****Burner operation**

Fig. 1

**Switching off the Cool Box**

If you do not intend to use the Cool Box for a long time, proceed as follows: Turn the knob to “0”.

Clean the inside. (see the “Cleaning and maintenance” below).

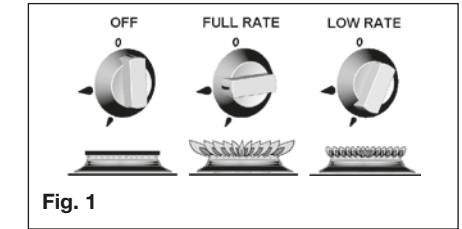
Leave the lid open to avoid unpleasant odours building up.

**Cleaning and Maintenance**

**Warning:** Do not use abrasive cleaning agents or hard objects during cleaning as these can damage the Cool Box. Never use brushes, scouring pads or hard or pointed tools to remove ice or to loosen objects which have frozen in place.

1. Clean the interior of the Cool Box regularly as soon as it becomes dirty with a damp cloth.
2. Wipe the Cool Box dry with a clean cloth after cleaning.

**Energy saving tips**

- Allow food to cool down first before placing it in the Cool Box.
- Do not open the lid more often than necessary.
- Do not leave lid open for longer than necessary.
- Defrost the Cool Box as soon as a layer of ice forms.
- Avoid unnecessarily low temperatures.
- Clean the condenser of dust impurities at regular intervals.
- Clean the lid seal regularly.

**IMPORTANT**

- Although each burner will support pans from 10 to 22cm, care should be taken not to overload the appliance as performance may be reduced.
- The following pan sizes are the maximum:
  - Auxiliary Burner:- Ø200mm Semi-Rapid Burner:- 2x Ø200mm or 1x Ø220mm with 1x Ø180mm
  - Electric Hotplate:- Ø180mm
- When using small pans the flames should not spread beyond the base of the pan as this will reduce the efficiency of the burner.
- Avoid old or misshapen pans as these may cause instability.
- The lid must be opened fully prior to using the hotplate burners.

## COOKER OPERATION

## Using the Hotplate Gas Burners



1. Ensure gas cylinder is connected and turned on and the shut off valve at the manifold is open. In the event of a gas smell turn off at gas cylinder and contact supplier.
2. Flame supervision: Each burner is controlled individually and is monitored by a thermocouple probe. In the event of the burner flames being accidentally extinguished, turn off the burner control and do not attempt to re-ignite the burner for at least one minute.
3. To light: Push in the control knob and turn to full rate – see Fig.1. Hold a lighted match or taper to the burner and push the control knob in and hold. It is necessary to hold the knob depressed after the burner has ignited for approximately 10 - 15 seconds, to allow the thermocouple probe to reach temperature, before releasing the knob. Should the flame go out when the knob is released, the procedure should be repeated holding the knob depressed for slightly longer.
4. For models fitted with Spark Ignition the procedure is similar except that the burner can be ignited by depressing the ignition button, which is located on the fascia. If the burner has not lit within 15 seconds the control knob should be released and the burner left for at least 1 minute before a further attempt to ignite the burner.
5. For simmering, turn the knob further anti-clockwise to the low rate position.
6. To turn off: Turn the control knob until the line on the control knob is aligned with the dot on the control panel. Always make sure the control knob is in the off position when you have finished using the hotplate burners.

## OPERATION

## Using the Electric Hotplate

Ensure the electricity is switched on.

The hotplate control is numbered from 1 to 6. To turn it on, rotate the knob either clockwise or anti-clockwise to the required position. Position 1 is the coolest setting.

To turn the hotplate off, rotate the knob until the line or pointer on the knob lines up with the zero on the control panel.

The hotplate is a sealed construction and transfers heat through conduction. For maximum efficiency a correctly sized pan with a flat heavy gauge base should be used. Pan size should be the same or slightly larger (up to 1" / 2.5cm oversize).

Before using your hotplate for the first time, we recommend that you prime and then season it.

## To prime the Hotplate

Switch on the hotplate for a short period, without a pan, to harden and burn off the coating.

Use a medium to high setting for 3 – 5 minutes. A non toxic smoke may occur during this process. Allow it to cool, then season.

## To season the Hotplate

First heat the hotplate for 30 seconds on a medium setting, then switch off. Pour a minimal amount of unsalted vegetable oil onto a clean dry cloth or paper towel, and apply a thin coat of oil to the hotplate surface. Wipe off any excess oil, then heat the hotplate on a medium setting for 1 minute. Occasional seasoning will help to maintain the Hotplate's appearance.

## WARNING

- Glass lids may shatter when heated. Turn off the hotplate and allow it to cool before closing the glass lid.
- Remove all spillage from the surface of the glass lid before opening.
- The glass lid has the tendency to snap shut towards the end of lowering.

This is caused by the travel lock action of the hinges as it is activated.

Make sure all fingers are removed from appliance when closing the lid.

## IMPORTANT

- Depending on specification, your appliance may be fitted with a glass lid shut-off system, which cuts off the power to all hotplate burners (gas and electric) if the lid is closed.
- Ensure the glass lid is in the open and upright position before turning on the hotplate burners.
- Not all models are fitted with the shut-off system.

## OPERATION

## WARNING

- THE GRILL MUST ONLY BE USED WITH THE DOOR OPEN.
- On combined grill and oven cookers THE HEAT DEFLECTOR BELOW THE FASCIA SHOULD BE PULLED OUT PRIOR TO LIGHTING THE GRILL. NEVER ADJUST THE HEAT DEFLECTOR POSITION WITHOUT USING HAND PROTECTION I.E. OVEN GLOVES. See Fig 3

On separate grill and oven cookers the grill area can get hot when the oven is in use, even if the grill is switched off.

- Care should be taken when removing pans from the grill, i.e. use of oven gloves, and by making use of the removal grill pan handle.



## IMPORTANT

- The grill pan supplied is multi functional, for use in grill or oven.
- The handle design allows removal or insertion whilst the pan is in use.
- Always remove the handle when the pan is in use.
- The grill MUST only be used with the door open.

## Using the Grill

1. Ensure gas cylinder/supply is connected and turned on. In the event of a gas smell turn off at gas cylinder/mains and contact supplier.
2. To light: Open door, push in the control knob and turn to full rate – see Fig 1 (page 137). Hold a lighted match or taper to the burner and push the control knob in and hold. The burner should ignite and the control knob should be held in for 10 -15 seconds before release.

If the burner goes out, repeat procedure holding control knob for slightly longer.

3. For models fitted with Spark Ignition the procedure is similar except that the burner can be ignited by depressing the ignition button, which is located on the fascia. Ignition must be carried out with the door open, and if the burner has not lit within 15 seconds the control knob should be released and the grill left for at least 1 minute before a further attempt to ignite the burner.
4. **Note:** the grill must only be used with the door open.



COOKER OPERATION

5. On first use of the grill, it should be heated for about 20 minutes to eliminate any residual factory lubricants that might impart unpleasant smells to the food being cooked. A non-toxic smoke may occur when using for the first time so open any windows and turn on mechanical ventilators to help remove the smoke.
6. Although the grill does heat up quickly, a few minutes preheat is recommended.
7. Flame Failure Device (FFD): the grill burner is fitted with a flame sensing probe, which will automatically cut off the gas supply in the event of the flame going out. In the event of the burner flames being accidentally extinguished, turn off the burner control and do not attempt to re-ignite the burner for at least one minute.
8. It is normal for the flames on this burner to develop yellow tips as it heats up.
9. A reversible grill pan trivet enables the correct grilling height to be achieved.
 

Fast Toasting	trivet in high position
Grilling Sausages	trivet in high position
Grilling Steak/Bacon	trivet in high position
Grilling Chops, etc	trivet in low position
Slow Grilling	trivet removed
10. To turn off: turn the control knob until the line on the control knob is aligned with the dot on the control panel. Always make sure the control knob is in the off position when you have finished grilling.

**IMPORTANT:**

- The pan supplied with the appliance is multi functional, for use either whilst grilling or when using the oven.
- The handle design allows removal or insertion whilst the pan is in use.

**Warning:** Pans must not touch the glass lid.

**Advice:** To avoid heat build up around the hob open the kitchen window slightly to allow the heat to dissipate.

**OPERATION  
IMPORTANT**

- The appliance is fitted with a cooling system. The cooling fans should automatically switch on a couple of minutes after the grill and/or oven is turned on, and will remain on even after the appliance has been switched off.
- The fans should automatically switch off a few minutes after the appliance has been switched off, when the front of the appliance has cooled sufficiently.
- A constant 12V supply is necessary at all times to ensure the cooling system operates correctly.

**Using the Oven**

1. Ensure gas cylinder/supply is connected and turned on. In the event of a gas smell turn off at gas cylinder/mains and contact supplier.
2. To light: Open door, push in the control knob and turn to full rate (240°C). Hold a lighted match or taper to the burner and push the control knob in and hold. The burner should ignite and the control knob should be held in for 10 -15 seconds before release. If the burner goes out, repeat procedure holding control knob for slightly longer.
3. For models fitted with Spark Ignition the procedure is similar except that the burner can be ignited by depressing the ignition button, which is located on the fascia. Ignition must be carried out with the door open, and if the burner has not lit within 15 seconds the control knob should be released and the oven left for at least 1 minute before a further attempt to ignite the burner.

4. Place the oven shelf in the required position and close the door. Set control knob to approximately 200°C and heat the oven for about 30 minutes to eliminate any residual factory lubricants that might impart unpleasant smells to the meals being cooked. A non-toxic smoke may occur when using for the first time so open any windows and turn on mechanical ventilators to help remove the smoke.
5. Although the oven does heat up quickly, it is recommended that a 10 minute preheat be allowed. The oven should be up to full temperature in about 15-20mins.
6. To turn off: turn the control knob until the line on the control knob is aligned with the dot on the control panel.
7. Shelf: the shelf has been designed to allow good circulation at the rear of the oven and is also fitted with a raised bar to prevent trays or dishes making contact with the back of the oven. To remove a shelf, pull forward until it stops, raise at front and remove.

**Important:** The pans and trays supplied with this appliance are the maximum sizes recommended for use. Larger pans and trays may restrict good circulation of heat, increasing cooking times.

**Oven Temperature Control**

The temperature in the oven is controlled by a thermostatic gas tap and is variable over the range 130°C to 240°C. Approximate temperatures for the settings on the control knob are shown in the table below. The temperatures indicated refer to the centre of the oven and at any particular setting the oven will be hotter at the top and cooler towards the base.

The variation between top and centre, and centre to bottom is approximately equivalent to one gas mark. Good use can be made of the temperature variation in several dishes requiring different temperatures may be cooked at the same time. In this way maximum benefit can be obtained from the gas used to heat the oven. Care should be

taken not to overload the oven, adequate spacing being used to allow free circulation for heat.

**OPERATION**

**Cooking Guidelines**

Best results will be obtained by the shelf positions in this guide. It is not necessary to preheat the oven but advisable for a range of dishes. The oven is capable of full temperature in 15-20 minutes.

Most cookery books give details of the shelf positions and gas mark settings for each recipe. If in doubt about a recipe you intend to use, study the recipe carefully then find a similar dish in our guide and use our shelf position and gas mark setting recommendation.

Shelf positions are from the top down. When roasting with aluminium foil care must be taken that the foil does not impair circulation or block the oven flue outlet.

Gas Mark	Temperature (Centre - Shelf Pos. 2)	
1/4 - 1/2	265 - 275°F	130-135°C
1	285	140
2	300	150
3	330	165
4	355	180
5	385	195
6	410	210
7	430	220
8	445	230
9	465	240

## COOKER OPERATION

**DO'S AND DON'TS**

- DO** read the user instructions carefully before using the appliance for the first time.
- DO** allow the oven to heat before using for the first time, in order to expel any smells before the introduction of food.
- DO** clean the appliance regularly.
- DO** remove spills as soon as they occur.
- DO** always use oven gloves when removing food shelves and trays from the oven.
- DO** check that controls are in the off position when finished.
- DO NOT** allow children near the cooker when in use. Turn pan handles away from the front so that they cannot be caught accidentally.
- DO NOT** allow fats or oils to build up in the oven trays or base.
- DO NOT** use abrasive cleaners or powders that will scratch the surfaces of the appliance.
- DO NOT** under any circumstances use the oven as a space heater.
- DO NOT** put heavy objects onto open grill and oven doors.

**Leaks**

If a smell of gas becomes apparent, the supply should be turned off at the cylinder

**IMMEDIATELY.** Extinguish naked lights including cigarettes and pipes. Do not operate electrical switches. Open all doors and windows to disperse any gas escape. LPG gas is heavier than air; any escaping gas will therefore collect at a low level. The strong unpleasant smell of gas will enable the general area of the leak to be detected. Check that the gas is not escaping from an unlighted appliance. Never check for leaks with a naked flame, leak investigation should be carried out using a leak detector spray.

**MAINTENANCE & SERVICING****IMPORTANT**

- Shut off gas supply at isolating valve, switch off electric supply and ensure all parts are cool before cleaning or servicing
- All servicing must be carried out by an approved competent person.
- After each service the appliance must be checked for gas soundness
- This appliance must not be modified or adjusted unless authorized and carried out by the manufacturer or his representative. No parts other than those supplied by the manufacturer should be used on this appliance.
- If the supply cord is damaged, it must only be replaced by the manufacturer or his representative in order to avoid a hazard.

This appliance needs little maintenance other than cleaning. All parts should be cleaned using warm soapy water. Do not use abrasive cleaners, steel wool or cleansing powders.

When cleaning the burner ring it is essential to ensure that the holes do not become blocked. The control knobs are a push fit and can be removed for cleaning. They are interchangeable without affecting the sense of operation.

**MICROWAVE OVEN GENERAL USER INSTRUCTIONS**

ALWAYS REFER TO THE MICROWAVE OPERATING INSTRUCTIONS SUPPLIED WITH THE VEHICLE

PRECAUTIONS TO AVOID POSSIBLE EXPOSURE TO EXCESSIVE MICROWAVE ENERGY

- Do not attempt to operate this oven with the door open since open door operation can result in harmful exposure to microwave energy. It is important not to defeat or tamper with the safety interlocks.
- Do not place any objects between the oven front face of the door or allow soil or cleaner residue to accumulate on sealing surfaces.

**c. WARNING** if the door or door seals are damaged, the oven must not be operated until it has been repaired by a competent person (1) door broken (2) hinges and latches (broken or loosened), (3) door seals and sealing surfaces.

**d. WARNING** it is hazardous for anyone other than a competent person to carry out a service or repair operation.

**e. WARNING** liquids or other foods must not be heated in sealed containers since they are liable to explode.

**f. WARNING** only allow children to use the oven without supervision when adequate instruction has been given so that the child is able to use the oven in a safe way and understands the hazards of improper use.

**g. WARNING** when the appliance is operated in the combination mode, children should only use the oven under adult supervision due to the temperature generated. (if provided)

## MICROWAVE OVEN

**IMPORTANT SAFETY GUIDANCE**

**WARNING:** -To prevent fire, burns, electric shock and other warnings:

Listed below are, as with all appliances, certain rules to follow and safeguards to assure high performance from this oven:

**IMPORTANT INSTRUCTIONS**

- Do not use the oven for any reason other than food preparation, such as for drying clothes, paper, or any other non food items or for sterilizing purposes.
- Do not use the oven when empty, this could damage the oven.
- Do not use the oven cavity for any type of storage, such as papers, cookbook, cookware etc.
- Do not operate the oven without the glass tray in place. Be sure it is sitting properly on the rotating base.
- Make sure you remove caps or lids prior to cooking when you cook food sealed in bottles.
- Do not put foreign material between the oven surface and door. It could result in excessive leakage of microwave energy.
- Do not use recycled paper products for cooking. They may contain impurities which could cause sparks and/or fires when used during cooking.
- Do not pop popcorn unless popped in a microwave approved popcorn popper or unless it's commercially packaged and recommended especially for microwave ovens. Microwave popped corn produces a lower yield than conventional popping; there will be a number of unpopped kernels. Do not use oil unless specified by the manufacturer.
- Do not cook any food surrounded by a membrane, such as egg yolks, potatoes, chicken livers, etc., without first piercing them several times with a fork.

## MICROWAVE OVEN

10. Do not pop popcorn longer than the manufacturer's directions. (Popping time is generally below 3minutes). Longer cooking does not yield more popped corn it can cause scorching and fire. Also, the cooking tray can become too hot to handle or may break.
11. If smoke is observed, switch off or unplug the appliance and keep the door closed in order to stifle any flames.
12. When heating food in plastic or paper containers, keep an eye on the oven due to the possibility of ignition.
13. The contents of feeding bottles and baby food jars shall be stirred or shaken and the temperature checked before consumption, in order to avoid burns.
14. Always test the temperature of food or drink which has been heated in a microwave oven before you give it to somebody, especially to children or elderly people. This is important because things which have been heated in a microwave oven carry on getting hotter even though the microwave oven cooking has stopped.
15. Eggs in their shell and whole hard-boiled eggs should not be heated in microwave ovens since they may explode, even after microwave heating has ended.
16. Keep the waveguide cover clean at all times. Wipe the oven interior with a soft damp cloth after each use. If you leave grease or fat anywhere in the cavity it may overheat, smoke or even catch fire when next using the oven.
17. Never heat oil or fat for deep frying as you cannot control the temperature and doing so may lead to overheating and fire.
18. Liquids, such as water, coffee, or tea are able to be overheated beyond the boiling point without appearing to be boiling due to surface tension of the liquid. Visible bubbling or boiling when the container is removed from the microwave oven is not always present. **THIS COULD RESULT IN VERY HOT LIQUID SUDDENLY BOILING OVER WHEN A SPOON OR OTHER UTENSIL IS INSERTED INTO THE LIQUID.**

**To reduce the risk of Injury to persons:**

- a. Do not overheat the liquid.
- b. Stir the liquid both before and halfway through heating it.
- c. Do not use straight-sided containers with narrow necks.
- d. After heating, allow the container to stand in the microwave oven for a short time before removing the container
- e. Use extreme care when inserting a spoon or other utensil into the container.

**CARE OF THE MICROWAVE**

1. Turn the oven off before cleaning
2. Keep the inside of the oven clean. When food spatters or spilled liquids adhere to oven walls, wipe with a damp cloth. Mild detergent may be used if the oven gets very dirty. The use of harsh detergent or abrasives is not recommended.
3. The outside oven surface should be cleaned with soap and water, rinsed and dried with a soft cloth. To prevent damage to the operating parts inside the oven, water should not be allowed to seep into the ventilation openings.
4. If the central panel becomes wet, clean with a soft dry cloth. Do not use harsh detergents or abrasives on Control Panel.
5. If steam accumulates inside or around the outside of the oven door, wipe with a soft cloth. This may occur when the microwave oven is operated under high humidity conditions and in no way indicates malfunction of the unit.
6. It is occasionally necessary to remove the glass tray for cleaning. Wash the tray in warm sudsy water or in a dishwasher.
7. The roller guide and oven cavity floor should be cleaned regular/y to avoid excessive noise. Simply wipe the bottom surface of the oven with mild detergent water or window cleaner and dry. The roller guide may be washed in mild sudsy water.

8. The oven should be cleaned regularly and any food deposits removed;
9. Failure to maintain the oven in a clean condition could lead to deterioration of the surface that could adversely affect the life of the appliance and possibly result in a hazardous situation.

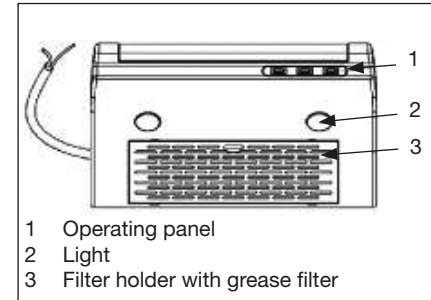
**Extractor hood 524**

The extractor hood 524 serves to extract water vapour from cooking areas in motorhomes. The integrated halogen lamps (2) serve to illuminate the work surface.

The fan and the lighting (2) can be switched independently via the operating panel (1). At the same time. The integrated grease filter (3) prevents the extraction system from being contaminated from inside.

**Safety information, always refer to the user instructions provided with your motorhome**

**Replacing the lamps on the extractor**

Lamp type: max. 10W /12V halogen with UVStop

Always switch off the lights before replacing the lamps! The lamps get very hot during operation. There is a risk of being burnt. Wait until the lamp has cooled down.

There is a risk of injury if the lamp is broken.

Remove the remainder of the lamp using suitable tools only.

## EXTRACTOR HOOD

**Replacing or cleaning the grease filter**

Flip the front part of the grease filter downwards.

Pull it out towards you.

Remove the filter holder

You can now exchange the filter. Fix the new filter in place with the filter holder. Finally, reinstall the filter unit in the reverse order.

Always switch off the fan motor before replacing the grease filter! There is a risk of injury when reaching inside the running fan.

**Replacing the grease filter**

To replace the filter, proceed according to figures 8 & 9.

Flip the front part of the grease filter downwards.

Pull it out towards you.

Remove the filter holder

You can now exchange the filter. Fix the new filter in place with the filter holder. Finally, reinstall the filter unit in the reverse order.

## THETFORD CASSETTE TOILET

### THETFORD C250CS & C250S CASSETTE TOILET

The toilet is made up of two parts: a permanently fixed part and a Waste Holding Tank that is accessible from the outside. The removable Waste Holding Tank is located under the toilet bowl and can be removed via a door on the outside of the motorhome.

#### PARTS

- a) Removable Seat and Lid
- b) Swivelling Toilet Bowl
- c) Blade Handle
- d) Flush Button
- e) Waste Holding Tank Level Indicator
- f) Rotating Emptying Spout
- g) Automatic Pressure Release Vent
- h) Sliding Cover
- i) Removable Mechanism
- j) Vent Plunger
- k) Pull-Out Handle
- l) Wheels
- m) Blade Opener
- n) Access Door to Waste Holding Tank
- P) Electric blade opener
- Q) Electric ventilator
- R) Waste pump-out system
- S) Waste holding tank multi-level indicator
- T) Flush water tank level indicator

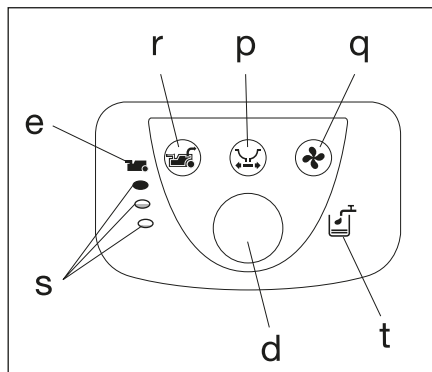
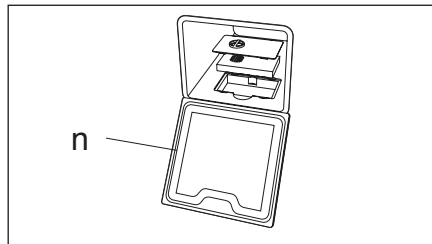
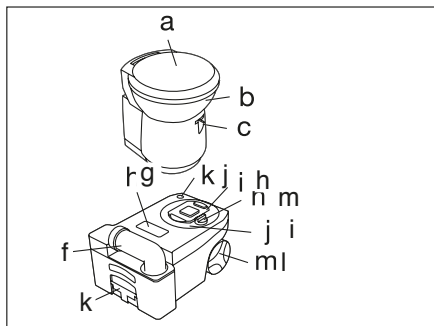

#### Control panel

Preparing for use

1. Open the access door on the outside of your motorhome.
2. Remove the Waste Holding Tank by pulling the safety catch (which holds the tank in place) upwards.
3. Pull the Waste Holding Tank outward to the stop. Tip it slightly and take the tank fully out.
4. Place the tank upright and turn the rotating emptying spout upwards. The emptying spout ensures that the tank can be easily and hygienically emptied.
5. Remove the cap, with the measuring cup inside, from the emptying spout and pour the correct dosage of Thetford toilet fluid (see product label) into the holding tank. This avoids unpleasant smells and keeps the inside of the tank clean. Next add approximately 2 litres of water - enough to ensure that the bottom of the Waste Holding Tank is covered. For more

information on Thetford toilet fluids, see last page of the Thetford user manual. Screw the cap back onto the emptying spout and turn back to its original position.

**Note.** The Emptying Spout Measuring Cap is supplied in the same packaging as the Thetford user manual.

**WARNING!** Never add toilet fluid directly via the blade or the toilet bowl as this could damage the lip seal of the Waste Holding Tank. Always pour the fluids via the emptying spout.

6. Slide the Waste Holding Tank back into its original position via the access door. Make sure that it is secured with the safety catch. Close the access door and lock it. Your Thetford toilet is now ready to use.

**WARNING!** Never use force if you cannot get the tank back into place easily. This may cause serious damage. If blockage occurs, always check if the blade handle is in the correct (closed) position.

#### Using the toilet

7. Turn the bowl to the desired position with the lid closed and using both hands.
8. To activate the control panel, press the flush-button once. The control panel display will stay activated for approximately 5 minutes. Run some water into the bowl by pressing the flush button again briefly.
9. The toilet may be used with the blade open or closed. To open the blade, slide the blade handle under the toilet bowl sideways. After use, open the blade (if still closed) and flush the toilet by pressing the flush button for several seconds (if necessary re-activate the control panel). Close the blade after use.

#### Emptying

The Waste Holding Tank has a capacity of 18 litres and requires emptying when the red light (LED) on the toilet control display lights up, when the Waste Holding Tank only has capacity for approximately 2 more litres, which is no more than two to three further uses.

Make sure that the blade is closed. Open the access door located outside the vehicle, pull the safety catch upwards and remove the Waste Holding Tank.

10. Place the Waste Holding Tank in an upright position (Pull-Out Handle at the top, Wheels at the bottom). Slide the handle sideways - to the front of the tank - until it snaps out of its locked position.
11. Pull the handle up and wheel the Waste Holding Tank to an authorised waste disposal point.
12. Push the handle back into its locked position. Turn the emptying spout upwards and remove the cap from the spout. Hold the Waste Holding Tank in such a way that during emptying you can operate the vent plunger with your thumb. To empty the tank without splashing, depress the vent plunger while emptying the tank. After emptying, rinse the tank and blade thoroughly with water.

**WARNING!** Do not seriously shake the tank or use high pressure water cleaners. This may cause damage to the tank's interior.

**Note.** The vent plunger should only be depressed once the emptying spout is pointing downwards. Prepare the toilet for re-use if required. Slide the Waste Holding Tank into the toilet and close the access door.

#### Cleaning and maintenance

The toilet should be cleaned and maintained regularly, depending on the amount of use. To clean Thetford toilets, we advise using water and Thetford Bathroom Cleaner.

**Note.** Never use bleach, vinegar or other powerful household cleaners that contain these substances. These may cause permanent damage to the seals and other toilet components.

## THETFORD CASSETTE TOILET

### Toilet bowl

- Squirt Thetford Bathroom Cleaner into the toilet bowl.
- Flush the toilet bowl with water and wipe down the rest of the toilet with a damp cloth.
- Clean seat and lid The seat and lid can easily be removed: Lift the seat and lid assembly and pull the round pins (inside the assembly) outwards from the pin holes. After cleaning, replace the seat and lid by positioning the round pins in front of the pin holes and push the lid and seat downwards.
- To keep your flush water fresh and to prevent deposits from forming in your toilet bowl, add a correct dosage of Aqua Rinse in your flush water tank, if present, on your toilet.

**Tip!** For a really shining toilet, dry with a soft dry cloth after cleaning.

### Waste holding tank

To keep your Waste Holding Tank fresh and clean, Thetford has developed a number of different toilet fluids. Thetford toilet fluids suppress smells, reduce formation of gas, promote breakdown of toilet waste and increase the life span of a mobile toilet. See page 50 of the Thetford user manual for more information. We advise a thorough cleaning of the Waste Holding Tank once each season, using Thetford's Cassette Tank Cleaner.

- Remove the removable mechanism from the Waste Holding Tank by turning it anti-clockwise and rinse it under a tap.
- Remove the cover plate from the Automatic Pressure Release Vent by prising it up using a small screwdriver. Use one hand to push the Automatic Pressure Release Vent open while holding the float of the Automatic Pressure Release Vent on the inside of the tank with the other hand. Push the float upwards, turn it 180 degrees and remove it from below. Remove the rubber seal underneath the float. Rinse the float and rubber seal under a tap. Replace the Pressure Release Vent using the same method in reverse.

The rubber seals in the toilet (the lip seal, the mechanism seal, the automatic pressure release vent seal and the cap seal) should be regularly cleaned with water and treated with Thetford High Grade Seal Lubricant. This will ensure that the seals remain flexible and in good condition. If the toilet is not to be used for any length of time, it is important to treat the seals with Thetford High Grade Seal Lubricant after cleaning.

**Note.** Never use Vaseline or any vegetable oil except olive oil. These may cause leakage or malfunction. The lip seal is a part of the toilet that is subject to wear. Depending upon the extent and manner of use, the seals will become less effective and will need replacing periodically.

### Winter operation

You can use your Thetford Cassette Toilet as normal in cold weather as long as the toilet is situated in a heated location. If there is a risk of freezing we advise that the toilet is drained by following the instructions under 'Storage'. For environmental reasons the use of antifreeze, such as that used in car radiators, is not recommended.

### Storage

It is important that you follow the instructions below if you do not expect to use your Thetford toilet for a long (winter) period.

- With the vehicle fresh water tank drained, (See "Fresh Water System" on page 43 for how to drain the tank), press the toilet flush button until water stops flowing into the bowl. Close the blade. Open the access door on the outside of your motorhome and empty the Waste Holding Tank at an authorised waste dump. Follow the instructions for cleaning and maintenance. To allow the Waste Holding Tank to dry, do not place the cap back on the emptying spout of the tank.

Thetford warranty refer to the Thetford user handbook.

## CASSETTE TOILET

Fault	Remedy
Bowl does not drain when toilet is flushed.  Cassette is overfilled	DO NOT REMOVE CASSETTE. While inside the motorhome turn flush knob anti-clockwise to open valve blade and leave it in the open position. Open access door on side of motorhome. Rotate pour-out spout outward. Place appropriate size container under spout cap. Remove cap carefully. Allow bowl contents to drain into container. This will lower the water level in the bowl. Replace cap and return pour-out spout to stored position. DO NOT REMOVE CASSETTE. Go inside the motorhome and turn the flush knob clockwise to close valve blade. Now, the cassette may be removed following the normal removal and emptying procedure.
Odours	Use proper amount of holding tank deodorant specified on bottle.
Soiled bowl after flushing	Partially fill bowl to cover soiled portion of bowl. Next flush will dissolve waste. Tip: Leave valve blade open during use.
No power to add water to toilet bowl	Check cassette safety sensor switch and fuse-holder for proper engagement and operation. Note: Cassette has to be removed to reach switch and fuse. Insert cassette and try adding water to toilet bowl. Toilet can be flushed manually. Add water. Add water to bowl from a separate container. Turn flush knob anti-clockwise to open valve blade. Turn clockwise to close valve blade.
Cassette cannot be removed	Check for obstacles under retaining clip. Depress retaining clip several times to check operation. Remove cassette. Flush knob and valve blade in partial open position. Close valve blade by moving knob clockwise.  <b>CAUTION: If valve blade is open during cassette removal, severe damage to system can occur. Never force insertion or removal of the cassette tank.</b>
Valve blade mechanism sticks or is hard to open	Spray light film of silicone on blade.
Major unit malfunction	Contact your original Motorhome Dealer.

TV INLET

**TV INLET**

Depending on specification, the motorhome may be fitted with an external co-ax connection in place of, or in addition to, connections for a roof mounted TV aerial. The external co-ax connection point will be within the battery box (Escape models) or the mains inlet enclosure (Sundance, E400, Borero and E500 models).

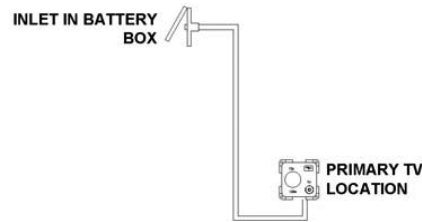

**Co-ax connection within battery box**

Within the battery box a White cover flap conceals a push-on type co-ax connection. A co-ax cable is fitted and connected within the motorhome from the back of this connection to the TV position within the motorhome.

An external TV aerial or site TV feed can be connected to the external connection point; signals from that connection will then be available at the TV position co-ax socket within the motorhome.

**Co-ax connection point within the mains inlet enclosure**

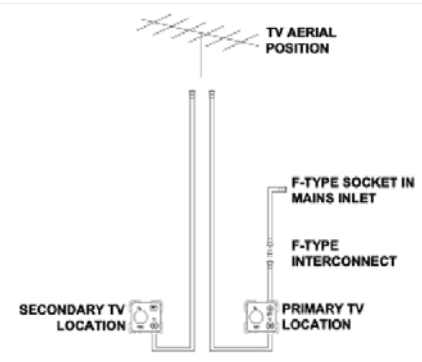

A short co-ax lead featuring a screw on co-ax connection will be present behind the Blue

mains inlet connector. A co-ax cable will be fitted and connected within the motorhome, from the back of this connection, to the primary TV position within the motorhome. At the same time, further co-ax cable or cables will be fitted which route from a likely TV aerial position (i.e. within the wardrobe) to each of the TV positions within the motorhomes.

The primary TV position will feature a socket marked 12v, TV, and SAT. The co-ax from the external connection point will route to the socket output marked SAT, whilst the co-ax from the wardrobe or similar will route to the socket output marked TV. At any secondary TV positions, if present, the co-ax from the wardrobe will route to the socket output marked TV.

An external TV aerial or site TV feed can be connected to the external connection point; signals from that connection will then be available at the primary TV position within the motorhome. As the connections are of the screw-on type, it is also possible to use this co-ax to route from an externally mounted satellite dish, to a satellite receiver.

**Co-ax connection point within the mains inlet enclosure, Satellite decoder position within the motorhome. (Kon Tiki and E700)**

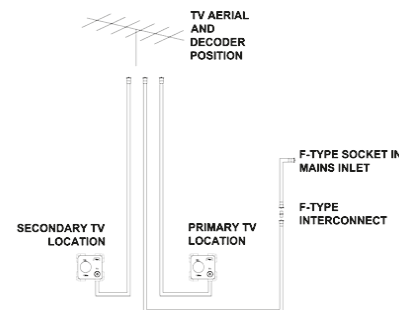

A short co-ax lead featuring a screw on co-ax connection will be present behind the Blue mains inlet connector. A co-ax cable will be fitted and connected within the motorhome, from the back of this connection, to the location intended for the later fitment of a

satellite decoder or similar receiver. At the same time, further co-ax cable or cables will be fitted which route from a likely TV aerial position (i.e. within the wardrobe) to each of the TV positions within the motorhome.

The external connection can be used to link a dish or external aerial, to the decoder / receiver position, and the co-ax leads from each TV point can then be used to link the decoder / receiver to each TV.

Depending on the type of decoder / receiver, it is possible that a modulator or similar component would be required to convert the output from the device (SCART or HDMI) into a signal that can be sent through co-ax cable.

## WINDOWS



To open, turn knobs anti-clockwise and open catches. Swivel the window pane open to the desired position and close knobs clockwise to lock in the open position.

To close, reverse the operation.

All opening windows have two catch positions. The first position is for ventilation the second seals the window from ventilation and rain.

## S2000 BLINDS (SEITZ)



## Blinds and Flyscreens

Flyscreen and blinds operate in the same manner. The flyscreen can only be 'fully up' or 'fully' down, but the blind also has an intermediate position.

To operate, pull down by holding the finger grip(s), gently ease towards the window to locate the catches. To retract, pull down easing away from the window to release the catches and guide to the required position.

- Only operate by holding the finger grip(s) - pulling on one side will cause uneven running and snagging.
- Do not allow the blind or flyscreen to recoil without control.
- It is not recommended that blinds and/or flyscreens are left in the down position for long periods, or when travelling, as this can result in fatigue of the spring.
- Clean the cassette, side track and fabrics with mild detergent and water.
- Lubrication of mechanism or spring is not required or recommended.

For more detailed information, see manufacturer's instructions.

## Cassette Blind and Flyscreen

Always hold the end rod in the middle. When closing blinds, slide the end rod of the flyscreen blind on to the end rod of the sun blind and engage. To open the blind push the end rods towards the darkening blind to the edge and disengage the end rods. Now move the end rod of the flyscreen back by hand - do not let it recoil.

Tensioning Seitz blinds and flyscreens  
Seitz S2000 window blinds/flyscreens are pre-tensioned, it may also be necessary in the future to adjust the tension of these. Remove the left hand top corner cap. Adjust the lower screw for the blind and the higher screw for the flyscreen. Care should be taken not to over tighten the springs.

The spring in the Seitz cassette window blinds/flyscreens are pre-tensioned. However, it may be necessary in the future to adjust the tension. The tensioning screw is positioned on the right hand top corner of the cassette. Firstly remove the plug then adjust by rotating the screw clockwise. Then replace plug.

The blinds should rewind without stopping or moving in a sluggish manner.

## OPERATING INSTRUCTIONS FOR BLINDS (SOFTROLLO)

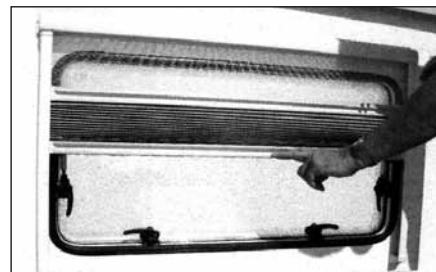

**Closing:** Grab the end bar in the middle and push the blind and flynet together or singly (blind - lower end bar) downwards until the required position is reached.

**Opening:** Push the end bar of the flynet and / or of the blind upwards.

**Care instructions:** Clean the blind only with a damp sponge. Clean on a regular basis to avoid dirt particle build up as this can damage the blind material. Use only water or with mild suds or a vacuum cleaner.

In order to avoid material fatigue, do not leave the flynet closed for a long time.

## WINDOWS/ ROLLER BLIND ADVICE

In case of prolonged exposure to the sun roller blinds should not be completely closed as this could cause excessive heat concentration at the top of the window, due to characteristics of the glazing material the windows could be adversely affected.

Roller blinds that shade from the bottom upwards it is necessary to leave a gap of a few centimetres open at the top, this way the heat between window and blind can escape. A fly screen does not cause an obstruction.

Roller blinds that shade from the top downwards must be kept completely open, or be opened regularly to allow the heat to escape.

Keeping the windows in ventilation position allows heat to escape.

Never fully close a roller blind system when storing the vehicle or when not in use for longer periods!

Therefore for optimal window life it is recommended:-

- Blinds starting at the bottom of the window a gap should be provided for ventilation at the top with the window in its ventilation position.
- For vehicles containing blinds from the top downwards or with other types of reflective blinds / curtains, please make sure that these blinds are also ventilated or not fully closed.

Ensure that all windows and roof vents are closed when the vehicle travels on the road.

## To adjust the tension of the Horrex blind:



In each corner piece there is a cord tensioner (see photo). By unscrewing the hexagon screw, the cord can move through the cord tensioner. When you pull the cord, the tension will get higher, when you let it move back the tension will get less.

## ROOF LIGHTS

When opening the roof lights, care must be taken to release the locking mechanism as the unit is raised.

Roof lights must be fully closed when driving. Roof lights provide essential fixed levels of ventilation.



### Mini Heki Rooflight

To open depress button and push bar upwards. The rooflight has two open ventilation positions and a fully open position.

The blind and flynet operate independently of each other and are engaged by connecting to each other and sliding.

**Heki care instructions:** Clean the blind only with a damp sponge. Clean on a regular basis to avoid dust/ dirt particle build up as this can damage the blind material. Use only water or with mild suds or a vacuum cleaner.

In order to avoid material fatigue, do not leave the flynet closed for a long time.

### Midi Heki Roof-light



**With operating bar:** To open, depress button and push bar to required position. The rooflight has two open ventilation positions and a fully open position.

To close, reverse the operation and then check if locked into position.



**With crank:** To open, rotate the crank until a resistance is noticeable during the operation.

To close, reverse the operation and then check if locked into position.



**Electric version:** To open, push button until desired position is reached or the electric motor switches off.

To close, reverse the operation and then check if locked into position.

## SKYVIEW OPERATING INSTRUCTIONS

### Safety and care instructions

**Before opening the dome please check if all handles are disengaged and no objects are in the opening area of the rooflight.**

To open, turn the handle anti-clockwise to the required opening position.



To close, turn the handle clockwise until the dome lies on the seal and a resistance is noticeable.

**Before you start your journey, close the rooflight by turning the handle to the closed position**

Please make sure that no persons or objects are in the closing area of the rooflight.

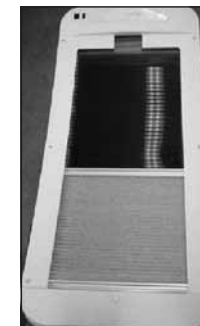

### Opening/closing the blind and fly net

Pull the end rod from the recessed part and push it in a position you desire. You can adjust the incidence of light with the second operating bar.

### Safety precautions

Repairs should be carried out only by trained personnel.

Inform an approved dealer in case of defects and malfunctions.

Before starting off, check the roof light for damage in the dome (tension cracks) and the opening mechanism which could arise owing to, for example, branches and other natural causes. Do not step on the screen.

Do not leave the vehicle with the roof light open (danger of burglary and water penetration).

Do not open in strong wind, rain or snowfall. Before opening, remove snow, ice, dirt etc. from the dome.

Malfunctions must be repaired by an approved dealer at once. Do not use caustic detergents (danger of tension cracks in the dome).

Before setting off close the dome and check the locking mechanism.

Avoid high speed (maximum speed recommended is 130 km/h). Do not close the blind more than 2/3 during the day (danger of heat build up). Before starting off, Open the blind.



**Care instructions**

Clean the dome with the Seitz acrylic cleaner.

Opaque spots and light scratches on the dome can be removed with the Seitz Acrylic Polish and the Seitz Special Polishing cloth.

Use talcum powder regularly (4 times yearly) to care for the rubber seals.

Clean the blinds only with water and mild soap suds or a vacuum cleaner.

**The guarantee becomes null and void if the care and safety instructions are not followed.**

**BLIND AND FLYSCREEN**

The blind and flyscreen operate independently of each other and are engaged by connecting to each other and sliding.

Safety precautions:

- Repairs should be carried out only by trained personnel.
- Inform an approved dealer in case of defects and malfunctions.
- Before starting off, check the rooflight for damage in the acrylic dome (tension cracks) and the winding mechanism which could arise owing to, for example, branches and other natural causes.
- Do not step in the acrylic dome.
- Close the roof light before starting off (check whether it is locked).
- Do not leave the vehicle with the rooflight open (danger of burglary or from rain).

- Do not open in strong wind or rain.
- Before opening, remove snow, ice, dirt, etc. from the acrylic dome.
- Malfunctions are to be repaired by an approved dealer at once.
- Do not use caustic detergents (danger of tension cracks in the acrylic dome).
- Do not operate whilst the vehicle is moving.

**Care instructions:**

- Please clean the acrylic panes with the Seitz Acrylic Cleaner.
- Stains and light scratches on the acrylic pane can be removed by using the Seitz Acrylic Polish and the Seitz special polishing cloth.
- Use talcum powder (4 times yearly) to care for the rubber seals
- Clean the blinds only with water and mild soap suds
- The guarantee becomes null and void if these instructions are not followed.

**CARE OF LAMINATE TOPS, TABLES, FURNITURE AND DOORS**

**DO NOT** use abrasives, chemically treated cloths or aggressive detergents as these may cause damage

**DO NOT** place hot objects on laminated surfaces i.e. tops, tables. Any temperatures 70°C and over will cause permanent damage.

Clean worktop surfaces, furniture and door fascias with a soft, slightly damp cloth, dry off with a soft cloth.

**DOORS**

In order to provide customers with the latest designs of door furniture it is possible, due to the use of natural wood, that warping may occur. This should not detract from the correct functioning of items fitted in the motorhome.

**Information**

During the normal travelling vehicle vibration and flexing may cause some of the furniture doors to become out of alignment.

For your convenience many hinges are adjustable.

**SEAT SWIVEL (DRIVER/PASSENGER)**

To turn the swivel, slide the BLACK lever rearwards and adjust to the required angle. Before driving off ensure the locking mechanism is fully secure.

**SIDE LOCKERS**

Some models are provided with exterior access locker doors. These are suitable for storing external equipment.

**BUNK AND LUTON BED SAFETY**

Where the sleeping surface is over one metre above floor level the following notices apply.

**WARNING:** Always ensure safety boards are located before entering the bunk.

**WARNING:** Use upper bunks for sleeping only, with the provided protection against fall out in position.

**WARNING:** Care shall be taken against the risk of fall out when the upper bunks are being used by children, especially under 6 years of age, these bunks are not suitable for use by infants without supervision.

Layouts with an over-cab bed (luton bed), access may be restricted when the lower bed (model specific) is fully extended at night time.

**TABLES**

**Note:** The free standing table legs have a positive locking mechanism. Care must be taken to ensure that, when folded, the leg which is closed first locks into the second position.

When engaging legs in down position the mechanism must be positively locked down.

**CAUTION! When erecting the free standing table, be careful to avoid trapping fingers.**





### TRIGGER SHOWER HEADS

- Squeeze trigger to release water. Release trigger to stop. Twist trigger up to gain permanent water flow, lower to stop.
- Care should be taken as water may become hot temporarily when switched on until it mixes and regulates.
- Small children should be supervised at all times when using the shower.
- We recommend unfastening the trigger shower head before travelling and storing safely to prevent it becoming detached whilst travelling.

### TABLE STORAGE

Tables stored in the table storage compartment must be securely clipped into place whilst in transit.

To avoid damage care must be taken when removing tables from their stored position.

### SHOWER

When using the shower, always ensure that the shower door is fully closed thus avoiding water spray on unprotected areas.

### 12V READING LAMP

**Warning: 12v reading/spotlamps generate high temperatures when in use, the body, lens/bulb may become very hot.**

**Never make directional adjustment in the direction of flammable materials i.e. Curtains, nets or blinds.**

### OMNISTEP SINGLE STEP

#### Operation

The OMNISTEP is operated by the lever switch.

Important: when extending the step, hold the switch until the step is completely extended. Never mount the step if retracted or if not fully extended, because then the blocking is not working and the motor can be damaged.

Check if the step is retracted before departure.

#### Maintenance

Dirt and frost can prevent the step from operating properly. In this case the moving parts should be cleaned or defrosted.

All points of movement are layered in maintenance-free bearings.

#### In case of electrical failure

If the step does not retract by motor: Loosen the square connection according to fig. 5 (actions 1, 2 and 3), push the footboard in (4) and tie it to the frame.

#### Current drawn

5 A. When fully extended or retracted: 14-18 A

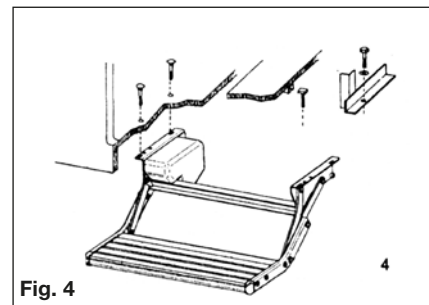

Fig. 4

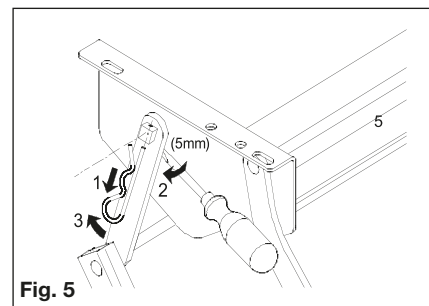
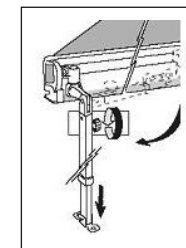
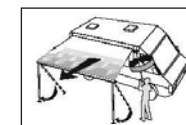

Fig. 5



Lower the leg as shown in the figure.



After unrolling the awning completely, adjust the legs at the chosen height.

To avoid that the awning is lifted up by an unexpected gust of wind, it is necessary to secure the legs to the ground with the provided hooks. For greater safety, we strongly advise you also use some storm cords in the upper part of each support leg or anchor the awning with the Fiamma Tie-Down Kit strap.

### FIAMMA F45S/TiL SIDE AWNING

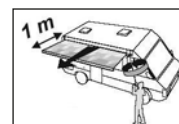

In order to avoid unnecessary strain on the awning as well as on the vehicle side, we suggest that the legs be extended about 1m from the opening.

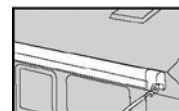

Unscrew the leg knob to slide the leg out of its seat.



Grasp the leg near its hinge joint and pull it in a horizontal direction.

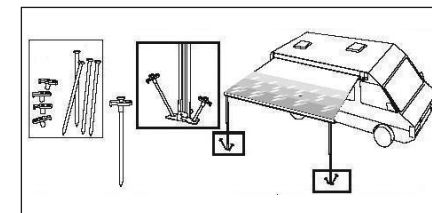

If you want to fasten the support legs to the vehicle, put the terminals into the wall brackets. The brackets can be fixed only in reinforced points.

**Caution:** Swift recommend that the awning be ground mounted only.

Side mounting brackets are supplied. But in inclement weather conditions may cause damage to the motorhome bodywork

**Caution:** The awning is a sun protection, please roll up your awning in case of rain, wind or snow.

Alternatively lower one side of your awning, so that water can flow away and assemble the tension rafter as shown in the figure (not included for all awning lengths).

Make sure that the awning perfectly rolls up: when it is, the red indicators on the front profile ends are no longer visible. A damaged fabric does not allow the awning to perfectly roll up. Never use the awning with a damaged canopy. Wash the canopy with Fiamma BRILL.

**NOTE: In case of problems refer to the awning user manual or contact your dealer.**

**Suggestions for use and maintenance for the fabric of your awning.**

Fiamma fabrics are made with PVC and Polyester layers and their properties can change in certain weather conditions.

For example, if you close the awning which has been opened in the sun for a long time, wrinkles can appear on the fabric.

In low temperature, the fabric becomes less pliable and there is a risk of cracks.

Please find here a list of some practical advice for the best and long lasting use of your awning:

1. Open and close the awning in normal condition of dampness and temperature (at night or in the morning) making sure the fabric has no sharp objects on it and is clean.
2. When closing the awning after a long period in the sun, wrinkles may appear and prevent the awning closing completely. In this case the security of the awning is not compromised, as the security winch will prevent accidental opening. If wrinkles appear re-open the awning and leave in the sun for some hours and the folds will disappear. Then of course you need to re-close the awning in normal conditions (see point 1).

3. Residual damp can cause spots on the fabric. If the awning has to be closed when the fabric is damp we suggest you re-open it as soon as possible to dry.
4. We suggest you avoid using the awning below freezing 0°C.
5. When closing the awning you should support the front bar.
6. Most of the dirt seen on the fabric will be superficial and can be cleaned with water and a cloth. Stubborn marks can be removed using a light detergent. Please do not use aggressive chemical substances and do not use high pressure cleaning tools.

### COLOUR REFERENCE

The colour code for touch ups or resprays for all white Fiat/Peugeot cabs and Swift coach built habitational body components is Fiat White 249. For Fiat/Peugeot cabs other than white, contact your Fiat/Peugeot dealer or obtain a colour match.

Please be aware that colours can fade over time, and therefore, if the vehicle is more than a few years old, it is suggested a colour match be obtained.

Silver motorhomes do not have a specified colour code, and therefore, a colour match must always be obtained.

### DROP DOWN TV MECHANISM

In some models, a drop down TV mechanism is used. Customers are reminded to engage both positive locks, on the underside of the TV mechanism before travelling. Failure to do so may result in damage of the TV unit or the TV shelf itself.

The inner dimensions (i.e. maximum TV size) for this unit is 336mm high x 390mm wide x 70mm deep.

### CYCLE RACKS

The Swift Group allows the fitment of a two cycle rack to our motorhomes and we have made provision for fixing blocks for this purpose.

Due to the complex nature of a cycle rack, the different models available and the need to break into the habitation box (therefore, having a potential of a leak), we suggest this modification only be carried out by a competent person, ideally, a Swift Group dealer or Authorised Repairer.

Please be aware a cycle rack can not be fitted onto a model where there is a rear escape window. Contact your dealer for clarification if your van has a rear window.

### TWIN LENSE REVERSE CAMERA SYSTEM

Depending on the specification of your motorhome, a reverse camera system may be installed. The system uses a pair of cameras mounted at high level on the rear of the motorhome, connected to an LCD screen which forms part of the rear view mirror, mounted on the windscreen. The two cameras give alternate views from the rear of the motorhome: A 'close' view, and a 'long distance' view.

The reverse camera system is powered whenever the vehicle engine is running.

With the vehicle in neutral, or in a forward gear, it is possible to switch the screen ON (using the power button on the mirror), and then using the V1/V2 button on the mirror switch between the two different views.

When reverse gear is selected (with the engine running) the mirror will automatically switch on (if not already on), and will display the 'close' image.

FITTED EQUIPMENT

Vehicle Modifications & non-standard parts .....	164
Motorhome exterior .....	164
Motorhome interior .....	166
Winterisation .....	168
AL-KO exhaust system.....	171
Caring for the environment .....	171

## VEHICLE MODIFICATIONS & NON-STANDARD PARTS

As the owner of a Swift Group Product, you are able to make any modifications you wish, either by yourself or through a dealer, without affecting the Swift 3/6 Year Warranty.

However, please be aware that any issues, resulting directly or indirectly, from a modification or fitment of a non-standard part, will not be covered by The Swift Group Warranty.

**WD40 is not recommended for external or internal use**

**WD40 attacks paintwork and sealants.**

**If a lubricant is required for Interior hinges, Sliding door tracks, Exterior door hinges, Plastic tracking etc.**

**We recommend "Ambersil 40+" this is readily available from most DIY/ Automotive spare part retailers**

Before carrying out any DIY work within the warranty period (3/5) years please check with your Swift Group dealer.

## MOTORHOME EXTERIOR

### Aluminium Panels

The stove enamelled paintwork is very durable and easy to clean owing to the high gloss properties.

### Plastic Panels (GRP/ABS)

These are used for front and rear panels and, in some cases for the roof.

### Cleaning

For both aluminium panels and plastic panels.

1. Wash the motorhome regularly with mild detergent. Rinse with cold water and leather off.
2. For better protection a similar coloured good quality car wax may be applied.

For sealed areas a mild soap is the best way to clean without affecting the sealant.

Acid or alkaline based cleaners or solvents should not be used.

**WARNING:** Under no circumstances use any abrasive cleaning agents or solvents on the exterior. Do not wash your motorhome with a high pressure washer as these can permanently damage the seals of your motorhome.

Care should be taken as the silicon in some polishes can attack the rubber used on the exterior for seals and gaskets.

### Acrylic Windows

Wash windows carefully, as you would with the paintwork of your car, do not scrub windows prior to removing surface dirt and film with a hose pipe - trapped dirt could cause scratching.

Wash with a solution of warm soapy water, windows can then be dried off with a leather.

Small scratches can be removed, consult your dealer.

Catches and stays do not require any special attention or lubrication.

### Condensation

#### What is condensation?

Condensation is the change of water from its gaseous form (water vapour) into liquid water. Condensation generally occurs in the atmosphere when warm air rises, cools and loses its capacity to hold water vapour.

As a result, excess water vapour condenses to form droplets.

#### Why condensation occurs

Condensation occurs when warm moist air meets a cold surface. The risk of condensation therefore depends upon how moist the air is and how cold the surfaces of the vehicle are. Both of these depend to some extent on how the vehicle is used. In a motorhome with a cold outside wall, if the temperature of the wall falls below the dew point temperature, it is quite normal for condensation to occur predominantly on the external walls.

#### When condensation occurs

Condensation occurs usually in winter, because the motorhome is cold and because skylights, windows and doors are opened less and therefore the moist air cannot escape.

#### How condensation occurs

Condensation occurs often for short periods in bathroom and kitchen areas because of the steamy atmosphere, and quite frequently for long periods in unheated areas; it also occurs in cupboards or corners of rooms where ventilation and movement of air is restricted.

#### What is important

Two things are particularly important:

- To provide ventilation so that moist air can escape.
- To use the heating reasonably

### How can you prevent condensation

Provide ventilation so that moist air can escape.

- a) Good ventilation of kitchens when washing, cooking or drying damp clothes is essential. Open the skylights or windows slightly, but keep the door closed as much as possible.
- b) After showering, keep the bathroom window or skylights open, and shut the bathroom door long enough to dry off the room.
- c) In all other areas provide some ventilation. Fixed ventilation is provided in accordance with BS EN 721: 1998 this is through skylights and 'Heki roof lights' in the roofs and from ventilators through the floor under cookers, doors and in bed boxes it is important not to block these.

Too much ventilation in cold weather is uncomfortable and wastes heat. All that is needed is a very slightly opened window or skylights. Opening a skylight or 'Heki; rooflights partially or windows opened to about 1cm will usually be sufficient.

#### Provide reasonable heating

- a) Do not use portable paraffin or flueless gas heaters at all.
- b) If drying damp clothes or towels, open a window enough to ventilate the area and turn on the electric element of the space heater but do not hang items over the heater.
- c) Try to make sure that all areas are at least partially heated. Condensation most often occurs in unheated areas.

## EXTERIOR AND INTERIOR MAINTENANCE

- d) To prevent condensation, the heat has to keep room surfaces reasonably warm. It can take a long time for a cold motorhome to warm up, so it is better to have a small amount of heat for a long period than a lot of heat for a short time.

Motorhomes use only carefully selected insulation materials but unlike most rooms at home all walls are exterior walls, so they lose heat through all walls as well as the roof and floor.

Even in a well insulated motorhome with reasonable ventilation, it is likely that during cold weather (less than 10 deg C) condensation will occur. Ideally the temperature should be kept about 20°C although this is not always possible.

### Mould growth

Any sign of mould growth is an indication of the presence of moisture and if caused by condensation gives warning that heating or ventilation, may require improving.

### New vehicles

New motorhomes often take a long time before they are fully 'dried out' because of moisture in the materials used in the manufacture. While this is happening they need extra heat and ventilation. At least during the first winter trips and may require more heat than they will need in subsequent winters journeys. Allowance should be made for this.

### Changing Exterior Bulbs

ALWAYS REPLACE LIKE FOR LIKE

For individual replacement bulb specification, refer to your Service Handbook.

## MOTORHOME INTERIOR

Follow these guidelines to ensure your investment is receiving the very best attention.

### Side Walls, Roof Lining

A simple wipe over with a damp cloth and a very mild detergent is all that is needed.

### Soft Furnishings

Should be vacuumed occasionally to remove grit and sand and help to keep its smart appearance over the lifetime of the upholstery. The upholstery can be cleaned with a mild, reputable upholstery cleaner. It is recommended that the curtains and pelmets are specialist cleaned only. The foam used in cushions is manufactured to meet fire regulations. It requires time to return to its normal position after prolonged use.

### Work Surfaces

You should not stand very hot items on any of the work surfaces, especially models with polycarbonate moulded sinks and drainers.

### Cupboard Catches

It is advisable to lubricate all cupboard catches, sliding bolts and hinges from time to time. We recommend "Ambersil 40+" this is readily available from most DIY/ Automotive spare part retailers

### Kitchen Equipment

All the thermoplastic parts in these areas have easy clean surfaces. To ensure long life and to prevent damage you must not use any cleaning materials at all and ensure water temperatures do not exceed 70°C (putting cold water in first is suggested). After every use it is essential that you rinse with clean water only and wipe with a soft damp cloth. Failure to follow these simple instructions may result in premature failure or cracking which will not be covered by any guarantees (including extended warranties).

### Bathroom/Shower

These products should be cleaned immediately after use. Apply a warm, mild soapy water solution with a soft cloth and rinse with clean water immediately. Abrasive materials must never be used. For stubborn stains "Thetford Bathroom Cleaner" is recommended as the use of other cleaners may harm these products, cause premature failure and will invalidate the warranty. "Thetford Bathroom Cleaner is available from most motorhome/caravan dealer shops.

### Furniture

A simple wipe over with a damp cloth should be all that is required. Polishing with a proprietary brand of wax polish enhances and maintains furniture in showroom condition.

It must be remembered that because the frames of the doors are made of ash, which is a natural product, they can be affected by temperature and humidity and may bow under certain conditions. As conditions change they should revert to their original positions.

### Kitchen Drainer and Cutting Board

You should not stand hot items on to the removable plastic kitchen drainer. To wash use only warm soapy water, do not use chemicals and bleach.

### Changing interior bulbs

The majority of interior lights are LED, and in the unlikely event of a failure, the replacement of the whole unit is required. It is not possible to replace the "bulb" on these units.

For non LED lights remove the lens or lampshade to access the bulb.

ALWAYS REPLACE LIKE FOR LIKE

For individual replacement bulb specification, refer to your Service Handbook.

### Locker Header Fluorescent Tube Replacement

- Ensure power supply to light is switched off.
- Open locker, light is mounted above. Locate fixing screws (orientated towards ceiling) and remove.
- In the case of a side locker, a small furniture component onto which the light fitting is secured can now be removed.
- In the case of an upper welsh dresser ( or similar), a larger component carrying all the lights from above that piece of furniture may detach.
- Once the appropriate light fitting has been accessed, the tube should be twisted along its length to release the tube and allow it to be lifted from the fitting.
- Please see the bulb replacement chart for details of the type of tube fitted. In addition, different 'colour temperatures' of bulb are available. For a consistent appearance replace tubes with those of equivalent colour temperature: This will be stated on the fitted tube in the format '4200K' or similar.

## WINTERISATION

### WINTERISATION

The Swift Group recommends the following winterisation points for customers:

#### Servicing

Arrange (in advance) the yearly service and habitation check, if the motorhome's next service is due while the vehicle is stored.

#### Plumbing

Water expands as it is frozen, and so trapped water, when it expands, can damage the tap / valve / pump or pipe it is trapped within. For this reason, (in addition to reasons of hygiene), the water system should be fully drained when not in use, particularly in colder weather.

- Depending on model, open the fresh water tank drain valve to drain the tank, and leave open or remove the tank drain bung inside the tank, and leave open
- Open the drain valve (yellow handle) next to water heater, and leave open.
- Fully open all the taps and shower mixer, move mixer position to the middle, and leave all taps in the open position.
- Unscrew the shower head and shower hose, shake out remaining water and allow water to drain. It is advised to leave the shower head and hose disconnected.
- Run pump for a short time, until all water is expelled.
- After a short while the majority of water will have left the plumbing system. At this point however it is still important to ensure that the pump itself is 'dry'. During this part of the winterisation, a suitable absorbent cloth or container should be used to catch a small amount of spilled water that will result.

Disconnect the pipe work from the pump by pulling the blue quick release tabs, at either side of the pump, at right angles to the pipe work, then pulling the pipe and connectors from the pump. See Fig.1 Run the pump for a short while to expel any remaining water within the pump.

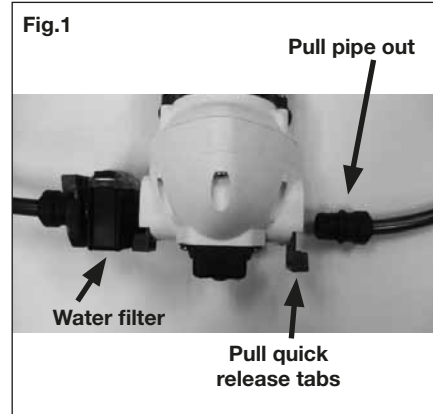

This is a good time to de-assemble and clean the pump filter. Squeeze either side of the filter housing to release the retaining tabs and pull the filter cassette out of the housing. See Fig 2

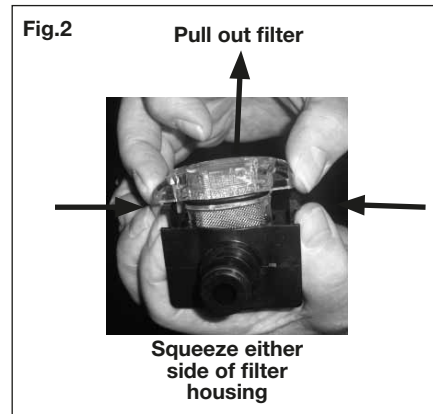

- Fit the cowl cover to the Truma Ultrastore, model specific.

- Open the waste tank drain valve, collecting the waste water in a suitable container, and leave open. Dispose of the waste water in a designated waste water area, clean waste pipes and tanks using a sterilising fluid. See "Waste Tank" section under services Page 45

#### Electrical

If vehicle is being stored while connected to 230v Mains Hook-up:

- Ensure that the leisure battery is connected and the 20A local fuse(s) is connected.
- The isolator switch on PSU should be in the 'ON' position, however, the control panel should be switched 'OFF'.
- If Alde system is installed, there is a frost protection setting, which can be used. See Alde user instruction manual.
- Vehicles can be left in this condition for extended periods, with the charger operating to maintain the battery. However, periodic maintenance and inspection is recommended, this should include the battery condition.

If vehicle is being stored not connected to 230v Mains Hook-up:

- Charge the leisure battery for 24 hours prior to placing motorhome in storage.
- Ensure the isolation button on PSU is in the 'OFF' position.
- Disconnect the negative terminal of the leisure battery or batteries.
- The battery should not be adversely affected by winter temperatures but the level of charge should be maintained to maximise the life span of the battery. This can be achieved using an automotive type battery charger as and when required.
- Disconnect the vehicle battery negative terminal. Check the charge of the battery every three months. (See Vehicle Inactivity section in the Fiat/Peugeot handbook).

#### Gas system

- Ensure the gas supply is isolated at the gas bottle, and ensure that the gas manifold taps are off.
- Check the age and condition of the high pressure gas hose and regulator, and replace if required.

#### Appliances

Check the battery expiry date on the smoke alarm and CO detector and replace or remove as required.

- Ensure the fridge is turned off.
- Clean the inside of the fridge.
- Prop the fridge door open, and if possible, the internal freezer compartment door for ventilation.
- Fit fridge vent winter covers (if available).
- Ensure all hob / oven / microwave surfaces are clean.
- If the motorhome is going to be left connected to 230v supply while not in use, ensure the microwave is unplugged.
- Clean the toilet and empty the cassette and lubricate the seals with an acid free lubricant such as Thetford High Grade Seal Lubricant. See Thetford toilet Users manual



**Exterior (Body / Chassis)**

- Ensure that all windows, skylights and access doors are closed and secured.
- Ensure all fixed ventilation points (high and low) are clear from debris and obstructions.
- Ensure the vehicle is not parked where falling debris (i.e. leaves, tree sap) could cause damage.
- Avoid leaving the vehicle parked in soft ground, long grass or a potential area where standing water may form.
- Lubricate relevant points on the chassis.

**Wheels and Tyres**

- Do not store in one position with partially deflated tyres. The tyre walls will suffer and do present a real danger of blow outs, especially when travelling at faster speeds than are allowed in the UK. The wheels should be turned every couple of weeks. If you are removing the wheels, follow the jacking procedure for changing a wheel. Check your tyres regularly for signs of age and deterioration, particularly wear, cracking and blistering. If in doubt consult a reputable tyre fitter.
- A purpose made cover maybe used, but please ensure the cover is a good fit, breathable and securely fitted.

**Note:** A poorly fitted cover can rub and damage the bodywork. Non-breathable covers will encourage mould to grow.

**Interior (Furniture / furnishings)**

- Open all lockers and internal doors, to ensure good circulation.
- Remove cushions and store them in a dry location or ensure all cushions are placed in a well ventilated area.
- Close all blinds and curtains. Customers are reminded to check the tension on blinds after storage if left closed for long periods.

- Thoroughly ventilate the motorhome by opening doors or windows periodically.
- Placing water absorbent crystals in the van during the winter months, will help reduce moisture levels and mould growth.
- We do not recommend leaving portable heaters in the van unattended.

**Recomissioning the Water System**

Re-connect the water pump by positioning the pipe connectors into the pump housing and pushing the blue tabs into position. It is advisable, after a period on non-use, to flush the water system with a sterilising fluid such as Milton 2. Fill the fresh water tank with water and sterilising fluid (Refer to sterilising fluid instructions for the amount to use). Turn the pump on and open all the taps, ensuring that the water drains away safely to the waste tank. When the waste tank is full empty the fluid into a designated waste water area. Re-fill the tank with fresh water and flush through the system as described above; repeat this until all traces of the sterilising fluid have been flushed out. (See "priming the Water System" and "Waste Tank" sections on page 44/45)

Prepare the toilet system by adding water and Thetford fluid to the toilet waste tank. See "Preparing the Thetford Cassette Toilet for Use" on page 146.

**Appliances**

Before starting motor caravanning after storage, check all gas appliances and electrical points.

**Note:** Preferably not less than once a year, the electrical installation should be inspected and tested by a qualified electrician.

After storage it is advisable to air the Motorhome and clean throughout, especially cooking appliances and the refrigerator.

Replace the bedding if they were removed for storage.

**Important:** Always follow the manufacturers recommended procedures after use of fitted equipment in the Motorhome, before storing for any length of time

**CHASSIS AND REAR AXLE**

Some models are built on Fiat/Peugeot base vehicles, the chassis of which has been converted by AL-KO. This conversion provides a hot dipped galvanised steel chassis coupled with a wide track rear axle utilising steel torsion bar suspension, imparting vastly improved stability and road holding.

**AL-KO EXHAUST SYSTEM**

A standard Fiat/Peugeot exhaust system is fitted, utilising an AL-KO modified tail pipe, available through your approved dealer. A standard Fiat exhaust system is fitted to all other models, with the addition of a Swift Group tail pipe.

**CARING FOR THE ENVIRONMENT**

After many years of service you may decide that your motorhome has become beyond economic repair and should be disposed of. Please ensure that you comply with the end of life vehicle legislation and take it to an authorised treatment facility where it will be properly dealt with to minimise any negative environmental impact. The transaction will be logged at the DVLA, identifying that you are no longer the owner of the vehicle.



## USEFUL INFORMATION

Owners Club .....	174
Spares and after sales Supercare .....	174
Repair facilities .....	174
Caravan Clubs .....	175
Motoring Associations .....	175
Trade Association .....	175
Change of ownership .....	177
Index .....	180

## OWNERS CLUB

The Owners Club is a completely independent organisation run for the benefit of the motorhome owners. They have numerous rallies during the year in various parts of the country. Apart from the friendliness and companionship the Club generates it is also actively engaged in charity work for those less fortunate than ourselves. The address of the Secretary of the Owners Club can be obtained from the Swift Group website.

## SPARES AND AFTER SALES CUSTOMER CARE

A catalogue of spare parts are available through our Swift Group Dealer Network, from door catches through to spare wheels. Please note, all parts enquiries must be directed through your dealer, as the Swift Group does not operate a direct retail service.

We endeavour to supply parts for vehicles up to 8 years old. If the original part is no longer available your dealer should be able to source a suitable alternative.

**Note: Please remember to quote chassis VIN (Vehicle Identification Number) when ordering any items from your dealer. This can be found at the bottom of the front windscreen, on the plate on the front cross member within the engine compartment and on the Swift manufacturers plate situated on the bulkhead directly behind the front driver/passenger seat.**

## REPAIR FACILITIES

Should you be unfortunate to encounter damage to your vehicle, we have a number of approved workshops and dealerships with workshop facilities to undertake such repairs. Details of which can be found via our website: [www.swiftgroup.co.uk/find-a-dealer](http://www.swiftgroup.co.uk/find-a-dealer)

The enjoyment of motorhoming can be greatly enhanced by membership of one or more of the various motorhome/caravanning, motoring and holiday clubs. Here are some useful addresses:

## CARAVAN CLUBS

### The Caravan Club,

East Grinstead House,  
East Grinstead  
West Sussex, RH19 IUA  
Tel: 01342 326944  
[www.caravanclub.co.uk](http://www.caravanclub.co.uk)

### The Camping and Caravanning Club,

Greenfields House,  
Westwood Way,  
Coventry,  
West Midlands.  
Tel: 0845 130 7631 or 024 7647 5448  
[www.campingandcaravanningclub.co.uk](http://www.campingandcaravanningclub.co.uk)

## MOTORING ASSOCIATIONS

### Automobile Association (AA)

Fanum House,  
Basingstoke,  
Hants. RG1 2EA  
Tel: 08705 448866  
[www.theaa.co.uk](http://www.theaa.co.uk)  
e-mail: [customer.services@theaa.com](mailto:customer.services@theaa.com)

### RAC Motoring Services

RAC Motoring Services  
8 Surrey St  
Norwich  
Norfolk  
NR1 3NG  
Tel: 01922 437000  
[www.rac.co.uk](http://www.rac.co.uk)

### The Society of Motor Manufacturers and Traders Limited (SMT)

Forbes House,  
Halkin Street,  
London SW1X 7DS  
Tel: 020 7235 7000  
[www.smmt.co.uk](http://www.smmt.co.uk)

### Green Flag

RBS Insurance  
Churchill Court  
Westmoreland Road  
Bromley  
Kent  
BR1 1DP

## TRADE ASSOCIATION

### NCC

Catherine House,  
Victoria Road,  
Aldershot,  
Hampshire, GU11 1SS  
Tel: 01252 318251  
[www.thencc.org.uk](http://www.thencc.org.uk)  
[www.motorhomeinfo.co.uk](http://www.motorhomeinfo.co.uk)  
e-mail: [info@thencc.org.uk](mailto:info@thencc.org.uk)

**CHANGE OF OWNERSHIP****NOTIFICATION OF CHANGE OF OWNERSHIP**

If you sell your motorhome, please notify the change of ownership by completing this page, detaching it and sending it to:

Swift Group Limited, Dunswell Road,  
Cottingham, East Yorkshire HU16 4JX.

Tel: 01482 875740

Please note that the benefit of any unexpired warranty cannot be transferred to the new owner until the change of ownership details above have been received.

DETAILS OF MOTORHOME:	Model:	_____
	Chassis No:	_____
	Registration No:	_____
	Serial No:	_____
CURRENT OWNER:	Name:	_____
	Address:	_____
		_____
		_____
NEW OWNER:	Name:	_____
	Address:	_____
		_____

NOTES

**Symbols**

230v mains electrical equipment . . . . . 60

**A**

Acrylic windows . . . . . 164

Alde Compact 3010 quick start guide . . . . . 98

Alde heating . . . . . 109

AL-KO exhaust system . . . . . 171

Assistance . . . . . 8

Awning . . . . . 159

Awnings and Tents . . . . . 40

**B**

Blind and flyscreen . . . . . 156

Blown air heating . . . . . 98

**C**

Caravan clubs . . . . . 175

Caravan exterior . . . . . 164

Caravan interior maintenance . . . . . 166

Care of laminate tops, tables, furniture  
and doors . . . . . 156

Caring for the environment . . . . . 171

Cassette toilet Thetford C250 CWE . . . . . 146

Central Locking . . . . . 20

Change of ownership . . . . . 177

Chassis and rear axle . . . . . 171

Children . . . . . 34

Child seats . . . . . 23

Cleaning . . . . . 164

Cleaning the Water System . . . . . 44

Co alarm . . . . . 36

Colour reference . . . . . 160

Condensation . . . . . 165

Cruise Control . . . . . 28

Cycle racks . . . . . 161

**D**

Domestic Waeco CB-40 Cool Box . . . . . 136

Doors . . . . . 157

Drop down TV mechanism . . . . . 160

**E**

EC400 Series Power Control System . . . . . 64

EC400 Series Technical Data . . . . . 78

EC462 . . . . . 67

EC467 . . . . . 67

Electrical overseas connection . . . . . 58

Electric Hotplate . . . . . 137

Environment . . . . . 18

Escape paths . . . . . 34

Extractor hood 524 . . . . . 145

**F**

Fire alarm test . . . . . 33

Fire and fire alarm . . . . . 32

Fire extinguisher . . . . . 34

Front locker and sunroof . . . . . 161

**G**

Gas . . . . . 52

Gas bottles . . . . . 52

Gas cylinder compartment . . . . . 53

Gas safety advice . . . . . 54

Grill . . . . . 137

**H**

Habitation relay . . . . . 84

Hartal exterior doors . . . . . 38

**L**

Large storage areas . . . . . 22

Leisure battery . . . . . 69

Levelling the motorhome . . . . . 40

Loading of vehicle . . . . . 21

**M**

Microwave oven . . . . . 144

Modifications . . . . . 164

Motorhome battery . . . . . 80

Motoring associations . . . . . 175

**O**

Omnistep single step . . . . . 158

Operating instructions for blinds . . . . . 153

Oven . . . . . 137

Owners club . . . . . 174

**P**

Positioning . . . . . 40

Power control system . . . . . 64

Pressure switch adjustment . . . . . 46

Priming the Water System . . . . . 44

**R**

Repair facilities . . . . . 174

Reverse camera system . . . . . 161

Roof lights . . . . . 154

Roof loading . . . . . 22

**S**

Seat belts . . . . . 22

Service inspection . . . . . 10

Shower . . . . . 158

Side lockers . . . . . 157

Skyview operating instructions . . . . . 155

Smoke alarm . . . . . 32

Solar panel connection point . . . . . 82

Spares and after sales customer care . . . . . 174

Spare wheel . . . . . 29

Supplier contacts . . . . . 9

Swift Talk . . . . . 2

**T**

Teb fan . . . . . 96

Thetford absorption refrigerators . . . . . 124

Thetford battery box . . . . . 81

Tow bar connection . . . . . 83

Towing . . . . . 24

Trade association . . . . . 175

Truma Combi 4 / Combi 6 . . . . . 99

Truma fault finding . . . . . 93

Truma Ultraheat additional electric heating . . . . . 97

Truma Ultrastore . . . . . 90

TV inlet . . . . . 150

Types of gas . . . . . 53

Typical appliance consumption figures . . . . . 61

Typical gas schematic drawing . . . . . 50, 51

**V**

Ventilation . . . . . 35

**W**

Warranty . . . . . 6

Waste water system . . . . . 45

Water system . . . . . 42

Water tanks . . . . . 43

Wild camping . . . . . 17

Windows . . . . . 152

Windows/ Roller blind advice . . . . . 153

Winterisation . . . . . 168

Wiring of connecting cable and caravan  
mains inlet . . . . . 59

All Swift Group models have been certified by the NCC for compliance with stringent European Standards, British Legislation and industry set Codes of Practice specifically relating to health and safety issues.

The approval process covers the testing and inspection of critical areas of the product from fire safety, weights and dimensions, to gas, electrics and ventilation. Every motorhome carries the "NCC Approved Motorhome" badge.

The NCC also conduct unannounced inspections at the Swift factory to ensure continued compliance. NCC Approval gives you peace of mind that your motorhome is legal and safe.

All Swift Group motorhomes are European Whole Vehicle Type Approved.

This is your assurance that these motorhomes meet all European regulations, and have been constructed and conform to approved standards of safety and manufacturing.

