



SWIFT GROUP

Dunswell Road
Cottingham
East Yorkshire HU16 4JX

Tel 01482 875740
Fax 01482 840082

email enquiry@swiftgroup.co.uk

For more information visit
www.swiftgroup.co.uk

Issued July 2016

Swift Group Quick Start Guide

Touring caravans & motorhomes

FIND OUT MORE SWIFTGROUP.CO.UK



BROCHURE
DOWNLOADS



FIND A
DEALER



FACEBOOK AND
SWIFT-TALK.CO.UK



PRODUCT VIDEOS
SWIFTTV.CO.UK

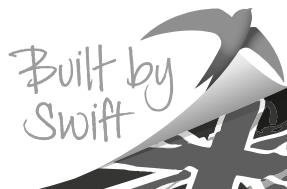

Contents

MASTER CONTROL PANEL CARAVAN / MOTORHOME

Power up caravan / motorhome	1
Prime the cold water system (caravans and motorhomes without water tanks)	2
Prime the cold water system (motorhomes/model specific)	3
Connect gas to caravan / motorhome	4
WAECO fridge (motorhomes only)	5
Operate Dometic fridge, gas operation	6
Operate Dometic fridge, (230V / Mains electric operation)	7
Operate Dometic fridge, electric (12V electric operation)	8
Operate Combi boiler, CP Plus controller	9
Operate Combi boiler, water heating CP Plus controller	10
Operate Combi boiler, space heating CP Plus controller	11
Operate Alde central heating system - controls	12
Operate Alde central heating system - hot water	13
Operate Alde central heating - space (and water) heating	14
Motorhome Alde heat exchanger for en-route heating	15
Operate WHALE heating - duo controller	16
Operate WHALE space heater - electric operation	17
Operate WHALE space heater - gas operation	18
Operate WHALE heater - electric operation	19
Operate WHALE water heater - gas operation	20

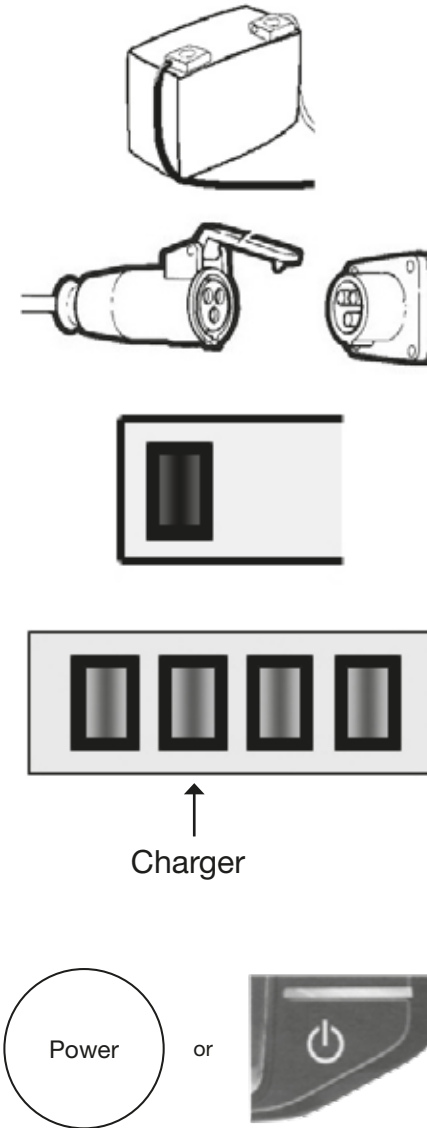

1. Connect leisure battery.
2. Plug 230V supply into caravan/motorhome then into site supply (if appropriate).
3. Press black isolator button on front of power supply unit to turn system on. (Button in)
4. Press green button on power supply unit to switch on charger.
5. Press power button on control panel (usually above entrance door).

System is now ready for use, lights can be turned on, appliances can be used etc.

NB. If after following any of the steps in this guide a problem occurs, please first consult your main handbook for further information, and if problems still persist contact your supplying dealer.

**PRIME THE COLD WATER SYSTEM
(CARAVANS AND MOTORHOMES WITHOUT WATER TANKS)**

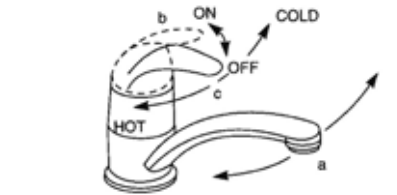
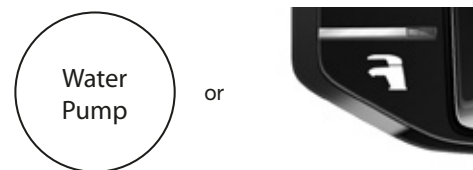
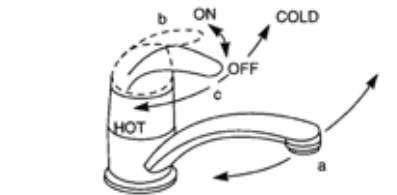
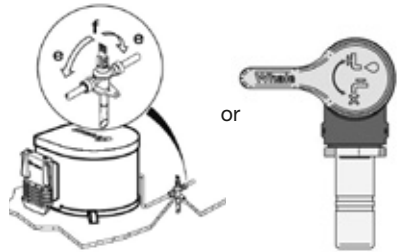

1. Fill external container and position supply of water close to external connection.

Submerge supplied external hose / pump in container, ensuring the end of the hose is below the water level.

Plug the external hose / pump into the side of the caravan, or motorhome if motorhome has no internal tank.

Note:

Caravans with two inlet housings then plug into the lower housing (upper is used to fill the water tank when fitted)

2. Locate safety/drain valve close to water heater and ensure handle is in horizontal position (e).

3. Close all taps except kitchen sink tap, which should be set to 'hot' position.

4. Press pump button on control panel, and wait until water is flowing from kitchen tap (this may take a few minutes).

5. Set kitchen tap to 'cold' and again wait, until water is flowing cleanly.

At vanity and shower taps / mixers, open to hot and then to cold until again water is flowing cleanly at each outlet.

**PRIME THE COLD WATER SYSTEM
(MOTORHOMES (MODEL SPECIFIC))**

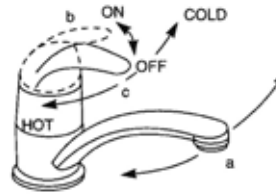
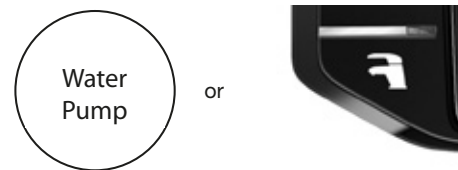
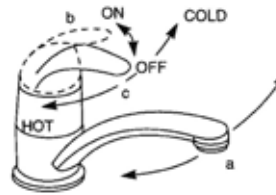
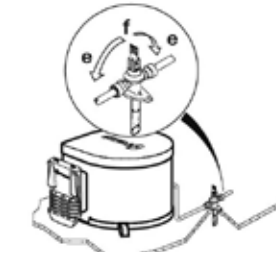

1. Locate fresh water tank in motorhome, if fitted. Ensure the tank drain is closed, using either the handle in the bed box (Kon-Tiki), the valve near the vehicle skirt (Autocruise), or the motorised valve control switch near the entrance door (other ranges). Open the fresh water tank filling cap, and using a food grade hose fill fresh water tank via this water inlet.

2. Locate safety/drain valve close to water heater, and ensure handle is in horizontal position (e). The appearance of the appliance may vary but the operation of the valve is the same for all models.

3. Close all taps except kitchen sink tap, which should be set to 'hot' position.

4. Press pump button on control panel, and wait until water is flowing from kitchen tap. (this may take a few minutes).

5. Set kitchen tap to 'cold' and again wait, until water is flowing cleanly.

At vanity and shower taps / mixers, open to hot and then to cold until again water is flowing cleanly at each outlet.

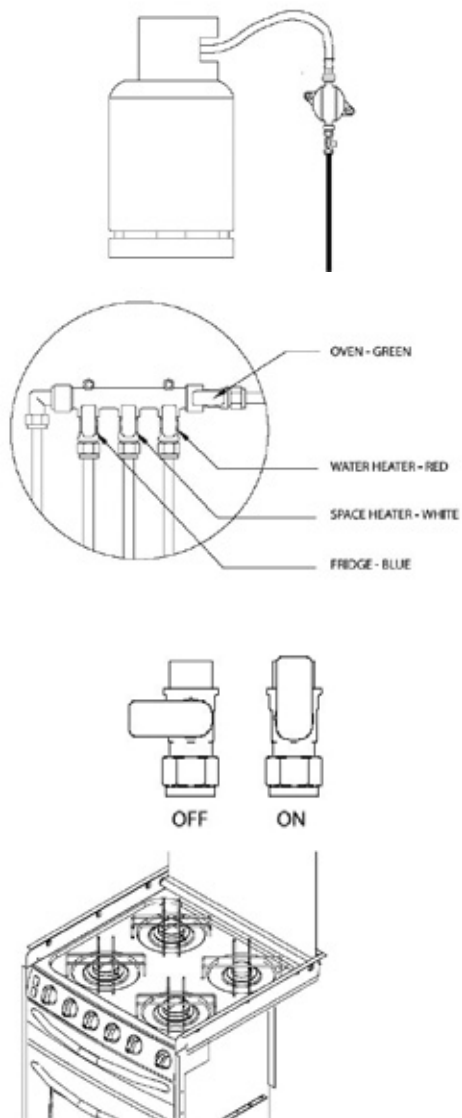

- Position the gas bottle and tighten the securing straps, then fix hose to regulator, and tighten using spanner. Fix other end of hose to gas bottle, again tightening using spanner.

Turn thumb wheel on gas bottle to turn on gas supply, and if regulator is 'Drive Safe' or 'Crash Sensor', please see Yellow label close to regulator for further instructions on re-setting safety features.
- Locate gas manifold, which is normally located in sink unit or wardrobe. Please note on some models more than one manifold is present, or a separate tap is fitted close to an appliance.
- Turn each tap to the 'ON' position
- Move to hob/oven. Open glass lid fully.

Press igniter on hob, turn one burner control to 'ON' position, and depress that control.

After a short while burner should light.

Gas should now be available at all appliances.

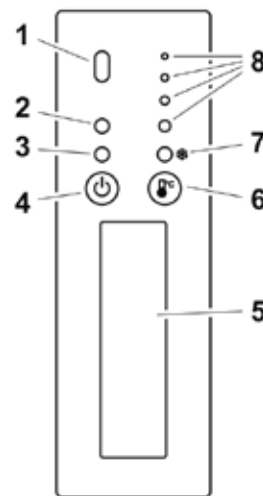

► Switch the refrigerator on by pressing the on/off button.

Note: After switching on, the refrigerator needs some time before the compressor starts up.

Setting the Temperature

- Press the temperature selection button to set the temperature to one of four levels between "cool" and "very cold". The number of LEDs which light up above the temperature selection button indicate the temperature range:
 - 1 = cool
 - ...
 - 4 = very cold
- Press the temperature selection button again to switch from level 4 to level 1.

The fridge will cool from any one of the following 12v supplies, assuming they are available:

- 1) On board battery charger, or Waeco transformer is fitted.
- 2) The selected battery (i.e. leisure battery)
- 3) The motorhome alternator, if the engine is running.

Please note: Allow the refrigerator at least two hours, or ideally run the refrigerator over night, to cool to a suitable temperature for storage of food, ideally with an electric hook up connected.

If using the motorhome without an electric hook up, please note the power consumption details for the fridge (see figures in handbook) - the fridge will automatically switch off if the motorhome battery becomes discharged.

Fig 2

	Explanation
1	IR sensor for switching the interior light
2	LED Service display
3	LED Green: Compressor is running Orange: Compressor is off
4	On/off button
5	Inner lighting
6	Temperature selection button
7	LED: Fast cooling function on (CRX50, CRX65, CRX80) LED: Winter mode on (CRX110)
8	LEDs: Temperature levels 1 to 4

OPERATE DOMETIC FRIDGE (GAS OPERATION)

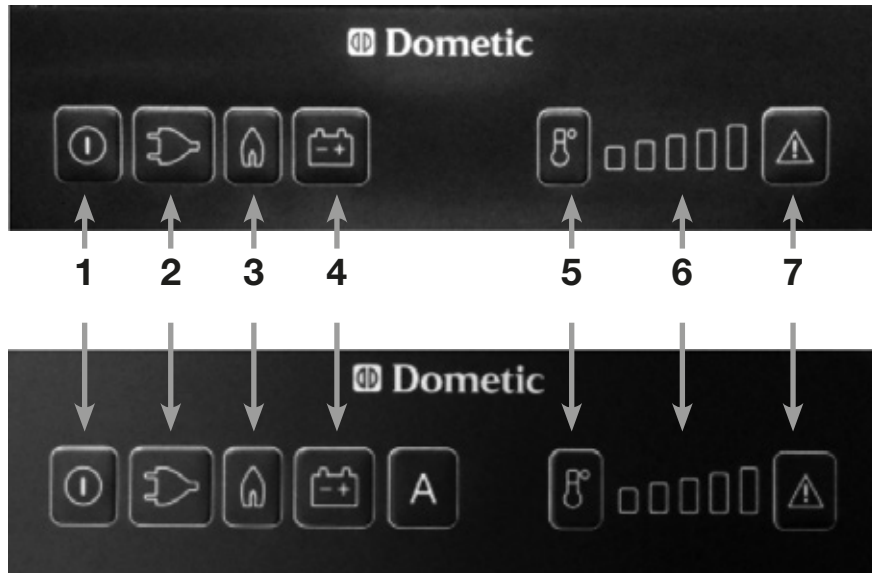

1. Press the power button (1) for approx. one second to switch on the fridge.
2. One of the three buttons (2), (3) or (4) will be illuminated. Press the button (3) to select gas operation.
3. After a short time the fridge will begin to operate. If a problem occurs (for instance no gas), then a warning will be displayed via flashing of the LED at position (7).
4. To adjust the temperature setting of the fridge, use button (5). Each short press will adjust the target temperature, with the LED's at position (6) showing the chosen setting. A colder target temperature is indicated by a greater number of illuminated LED's.

Please note: When using 230V or gas, allow the refrigerator at least two hours, or ideally run the refrigerator over night, to cool to a suitable temperature for storage of food.

OPERATE DOMETIC FRIDGE (230V / MAINS ELECTRIC OPERATION)

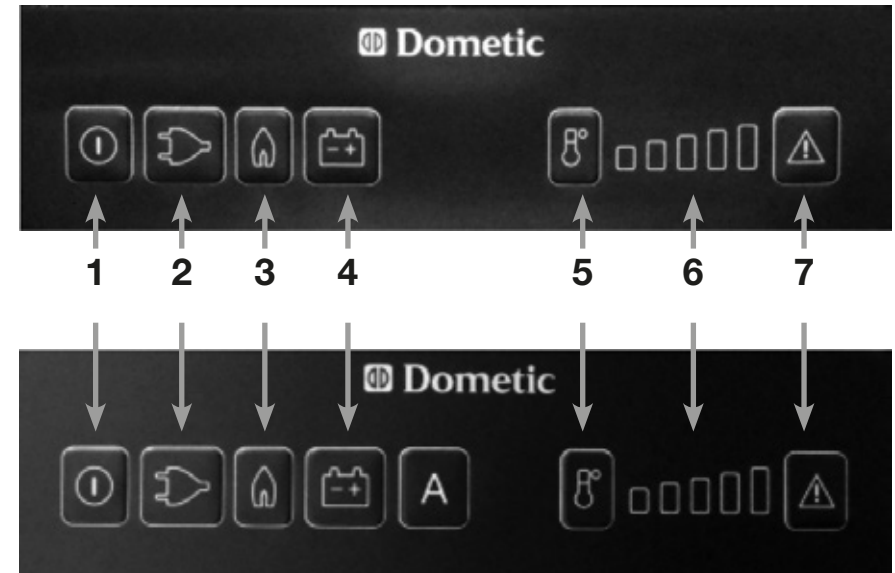

1. Press the power button (1) for approx. one second to switch on the fridge.
2. One of the three buttons (2), (3) or (4) will be illuminated. Press the button (2) to select mains / 230V operation.
3. After a short time the fridge will begin to operate. If a problem occurs (for instance no electric hook up), then a warning will be displayed via flashing of the LED at position (7).
4. To adjust the temperature setting of the fridge, use button (5). Each short press will adjust the target temperature, with the LED's at position (6) showing the chosen setting. A colder target temperature is indicated by a greater number of illuminated LED's.

Please note: When using 230V or gas, allow the refrigerator at least two hours, or ideally run the refrigerator over night, to cool to a suitable temperature for storage of food.

OPERATE DOMETIC FRIDGE (12V ELECTRIC OPERATION)

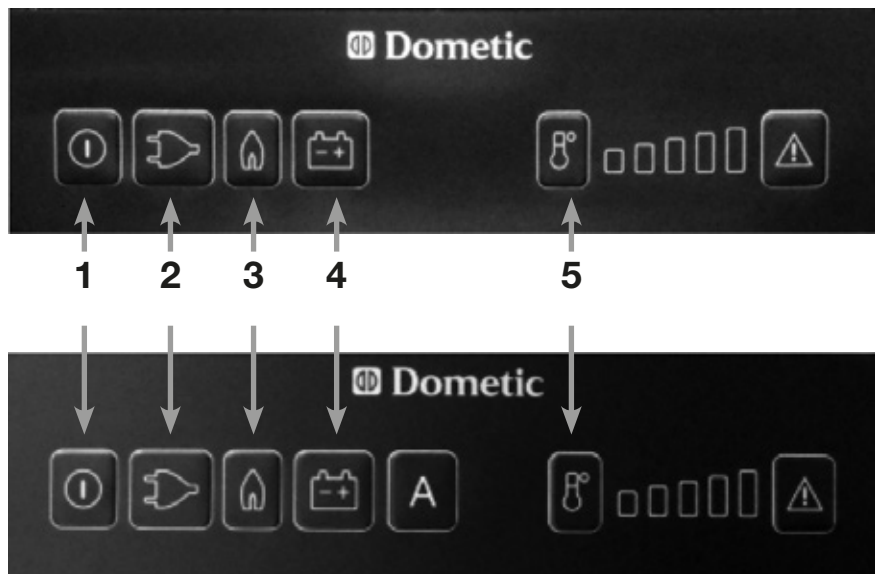

1. Press the power button (1) for approx. one second to switch on the fridge.
2. One of the three buttons (2), (3) or (4) will be illuminated. Press the button (4) to select 12V operation.
 In a motorhome the fridge will not operate/cool using a 12V supply, unless the engine of the motorhome is running.
 In a tourer, the fridge will not operate / cool using a 12V supply, unless the tow car is connected with it's engine running.
3. To adjust the temperature setting of the fridge, use button (5). Each short press will adjust the target temperature, with the LED's at position (6) showing the chosen setting. A colder target temperature is indicated by a greater number of illuminated LED's.

Please note: When using 12V (from the towing vehicle / motorhome alternator) to power the fridge, the fridge will only maintain its temperature, and will not 'cool' further. 230V or Gas power should be used for a sufficient time to cool the fridge prior to using 12V power.

OPERATE COMBI BOILER – CP PLUS CONTROLLER



Electrical isolation switch



Heating /
Hot water

The Truma Combi dual purpose boiler can be used for:

- a) Water heating using gas or mains electricity as an energy source.
- b) Space heating using gas or mains electricity as an energy source, with or without water in the system. (If space heating is used with water in the system, then the water will also be heated to an unspecified temperature).

This guide in the following pages explains basic operation with gas OR electric as an energy source, when using a Combi with the control panel shown above. For details including how to use gas and electric energy sources together, simultaneously control room and water temperatures, etc, see manual.

For control of heating using Swift Command, see main handbook.

The Orange 230V / Mains isolation switch on power supply unit must be ON / illuminated for electric operation of the Combi.

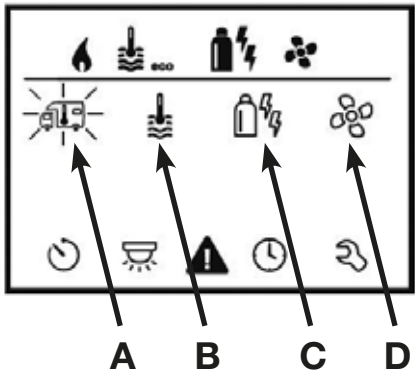

Press and hold the rotary control (8) for 3 seconds to turn the system ON – the display will alternate between time and temperature displays. Press the rotary control (8) to adjust settings – the display will then show the symbols row (3).

Rotate the control (8) until the vehicle symbol (A) is flashing, then press the rotary control (8) to allow adjustment of room temperature. Rotate the control (8) anti-clockwise until the display shows 'OFF', and press the rotary control (8) to confirm this selection.

Rotate the control (8) until the thermometer symbol (B) is flashing, then press the rotary control (8) to allow adjustment of water heating settings. Turn the rotary control (8) to select either Eco, Hot or Boost, and then press the rotary control to confirm the selection.

For water heating Electric operation

Turn the rotary control (8) until the energy symbol (C) is flashing, then press the rotary control (8) to allow the adjustment of energy selection.

Turn the rotary control until 'EL1' (1kw) or 'EL2' (2kw) is showing on the display, then press the rotary control to confirm.

For water heating Gas operation

Turn the rotary control (8) until the energy symbol (C) is flashing, then press the rotary control (8) to allow the adjustment of energy selection.

Turn the rotary control until 'GAS' is showing on the display, then press the rotary control (8) to confirm the selection.

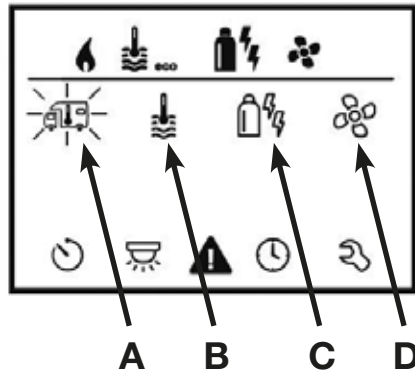

Press and hold the rotary control (8) for 3 seconds to turn the system ON – the display will alternate between time and temperature displays. Press the rotary control (8) to adjust settings – the display will then show the symbols row (3).

Rotate the control (8) until the vehicle symbol (A) is flashing, then press the rotary control (8) to allow adjustment of room temperature. Rotate the control (8) to show the desired room temperature, and press the rotary control (8) to confirm this selection.

Rotate the control (8) until the thermometer symbol (B) is flashing, then press the rotary control (8) to allow adjustment of water heating settings. Turn the rotary control (8) anti clockwise until 'OFF' is displayed, and then press the rotary control to confirm the selection.

For space and water heating Electric operation

Turn the rotary control (8) until the energy symbol (C) is flashing, then press the rotary control (8) to allow the adjustment of energy selection.

Turn the rotary control until 'EL1' (1kw) or 'EL2' (2kw) is showing on the display, then press the rotary control to confirm.

For space and water heating Gas operation

Turn the rotary control (8) until the energy symbol (C) is flashing, then press the rotary control (8) to allow the adjustment of energy selection.

Turn the rotary control until 'GAS' is showing on the display, then press the rotary control (8) to confirm the selection.

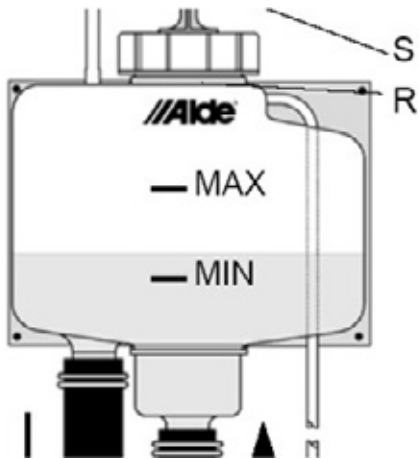

The Alde 3020 central heating system can provide hot water and room heating, from gas and/or mains (230V) electric energy sources. The room heating can be used with or without water in the heater.

Before using the central heating system check that the level of 'glycol' fluid which is used to heat the radiators, is between the min and max levels on the header tank. (Normally located in a wardrobe). If a circulation pump is mounted in this header tank, the pump must be enabled in the control panel settings menu, prior to first use. For details on how to enable this pump, please refer to the full Alde instruction document.

The Alde control panel is located above the entrance door, and is used to select energy source and water / room heating operations. This guide details basic settings only, for further details see manual. For control of heating using Swift Command, see main handbook.



To turn the panel on, press the power button as shown by the hand symbol. The heating system will return to previously used settings, until adjustments are made. Aside from the two buttons shown in this image, the panel operates via a touch-screen interface.



↑
Heating /
Hot water

The Orange 230V / Mains isolation switch on power supply unit must be ON / illuminated for electric operation of the Alde central heating system.

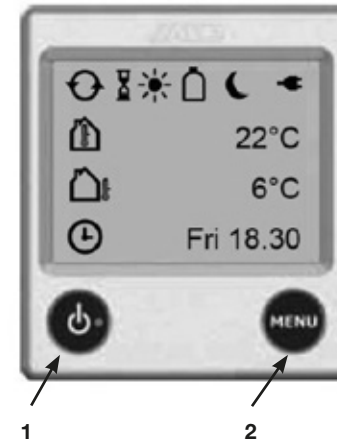

Whether using gas or electric operation, the water within the appliance can be heated, with its temperature regulated to approximately 50°C.

When the control panel is on, and an energy source is both available and selected, water within the appliance will be heated.

Press power button (1) to switch control panel on. Press the menu button (2) display the screen showing energy and temperature options.

For water heating Electric operation

Touch the screen on the row featuring a lightning flash, at position (4). Each press will increase the 230V element size, in the sequence 1kw, 2kw and then 3kw. The display will confirm the element size selected. The 3kw setting offers the greatest performance, but uses the most power - please check the available 230V supply.

For water heating Gas operation

Touch the screen on the row featuring a gas flame symbol, at position (3). The background colour of the flame symbol will change from Blue (off) to Green (on) to confirm that gas operation has been selected.

Please note: After a short time the display will switch back from the menu settings to the standby screen, if no areas of the screen are touched.

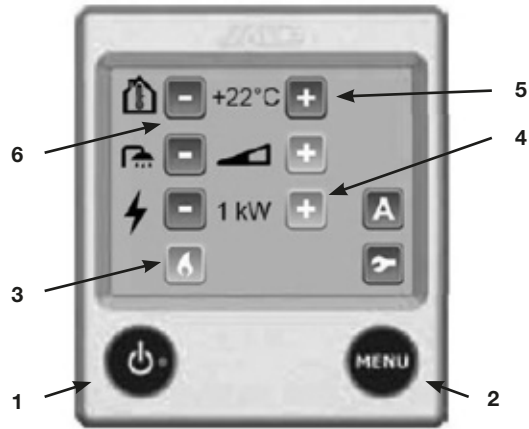

Whether using Gas or Electric operation, room heating can be operated. While the system is room heating, any water within the appliance will automatically also be heated. The heating system will switch on and off to maintain the temperature selected on the Alde control panel.

Press power button (1) to switch control panel on. Press the menu button (2) to enter the settings menu.

Touch the screen on the row featuring a thermometer. Touching the screen at position (5) will increase the target / desired room temperature, touching the screen at position (6) will reduce the target / desired room temperature.

For water heating Electric operation

Touch the screen on the row featuring a lightning flash, at position (4). Each press will increase the 230V element size, in the sequence 1kw, 2kw and then 3kw. The display will confirm the element size selected. The 3kw setting offers the greatest performance, but uses the most power - please check the available 230V supply.

For water heating Gas operation

Touch the screen on the row featuring a gas flame symbol, at position (3). The background colour of the flame symbol will change from Blue (off) to Green (on) to confirm that gas operation has been selected.

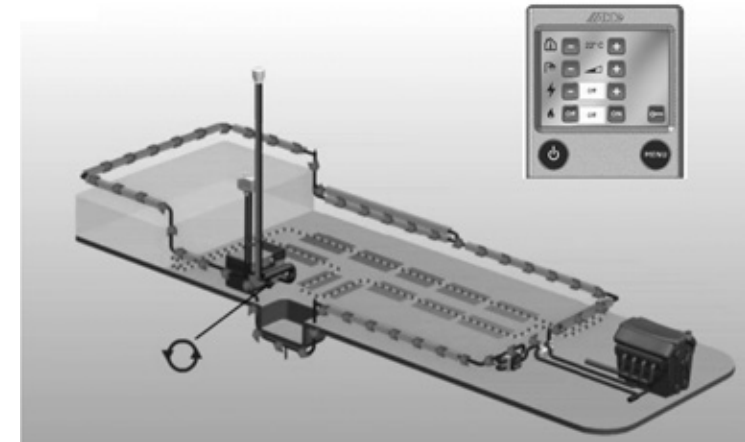

Some motorhomes are fitted with an Alde heat exchanger, which transfers heat from the engine of the motorhome (when available) to the heating system in the habitation area of the motorhome.

To use the heat exchanger

The Alde heating system must be switched on, while the motorhome engine is running, to heat the exchanger. The following settings on the Alde control panel are suggested:

- Turn Alde heating system ON using the power button at bottom left of the control panel.
- Press MENU button at bottom right of the control panel.
- Select a desired room temperature using the PLUS (+) and MINUS (-) buttons on the first row of the touch screen part of the control panel.
- Though not necessary for use of the heat exchanger, a water temperature can be selected using PLUS (+) and MINUS (-) buttons on the second row of the touch screen part of the control panel.
- As no 230V supply will be available while driving, the selection or deselection of the electric heating element, via the third row of the touch screen, is irrelevant.
- To use only heat sourced from the heat exchanger, gas heating is not required. Gas heating can be deselected by pressing the OFF button on the fourth row of the touch screen.

OPERATE WHALE HEATING - DUO CONTROLLER

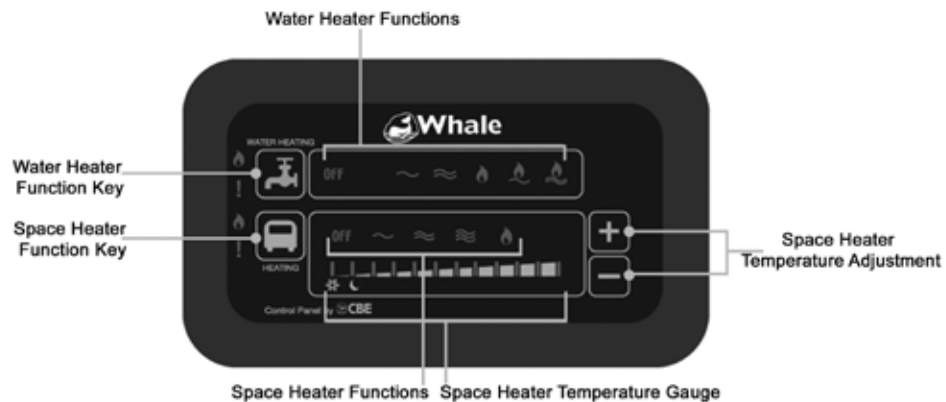

The Whale Duo control panel allows operation of the Whale space heater and Whale water heater from a single control panel. This guide describes basic operation, for further detail, and to operate the Whale space heater and water heater from the Swift Command system, please see main handbook.

It is possible to use space heating and water heating separately, so space heating can be used without priming the water system. It is possible to select gas or electric (230V) operation for either appliance.

Dual fuel operation of the water heater is also possible, see main handbook for details.

The water heater should not be switched on if the water system is not primed.

OPERATE WHALE SPACE HEATER - ELECTRIC OPERATION

Electrical isolation switch



Heating / Hot water

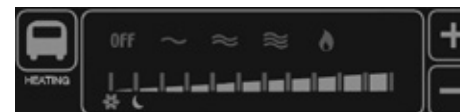
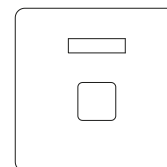

For 500w electric element



For 1000w electric element



For 2000w electric element



When a Power Setting has been selected, select a target room temperature using the *Temperature Up/Down* buttons. Press the *Temperature Down* button to move the Space Heater Temperature LED indicator to the left, and set a lower target temperature, and press the *Temperature Up* button to move the LED indicator to the right, and set a higher target temperature.

OPERATE WHALE SPACE HEATER - GAS OPERATION



Ensure a gas supply is present, as described earlier in this quick start guide.

On the Duo control Press the Space Heater On button and the power Settings indicators will illuminate one at a time. Each time the Space Heater On button is pressed, the next indicator will illuminate (moving from left to right), and show which power level has been selected.

For gas operation, the flame symbol as indicated here should be illuminated.

When a Power Setting has been selected, select a target room temperature using the *Temperature Up/Down* buttons. Press the *Temperature Down* button to move the Space Header Temperature LED indicator to the left, and set a lower target temperature, and press the *Temperature Up* button to move the LED indicator to the right, and set a higher target temperature.

OPERATE WHALE WATER HEATER - ELECTRIC OPERATION

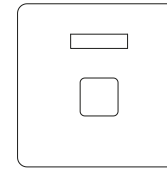

Locate the fused spur marked 'Water Heater' in the wardrobe and switch on.

Ensure the water system is primed, as described earlier in this guide.

On the Duo control press the *Water Heater On* button, and the Water Heater Power Settings indicators will illuminate one at a time.

For electric operation either of the following LED indicators should be illuminated:

For 750W electric element

For 1500W electric element

OPERATE WHALE WATER HEATER - GAS OPERATION



Ensure a gas supply is present, as described earlier in this quick start guide.
Ensure the water system is primed, as described earlier in this quick start guide.

On the Duo control panel press the Water Heater On button, and the Water Heater Power Settings indicators will illuminate one at a time.

For gas operation the following LED indicator should be illuminated:

For water heater gas operation